

An ITE Recommended Practice

Designing Walkable Urban Thoroughfares: A Context Sensitive Approach



Institute of Transportation Engineers

CONGRESS
FOR THE
NEW
URBANISM

The Institute of Transportation Engineers is an international educational and scientific association of transportation professionals who are responsible for meeting mobility and safety needs. ITE facilitates the application of technology and scientific principles to research, planning, functional design, implementation, operation, policy development and management for any mode of ground transportation. Through its products and services, ITE promotes professional development of its members, supports and encourages education, stimulates research, develops public awareness programs and serves as a conduit for the exchange of professional information.

Founded in 1930, ITE is a community of transportation professionals including, but not limited to transportation engineers, transportation planners, consultants, educators and researchers. Through meetings, seminars, publications and a network of 17,000 members, working in more than 90 countries, ITE is your source for expertise, knowledge and ideas.



Institute of Transportation Engineers
1099 14th Street, NW, Suite 300 West
Washington, DC 20005-3438 USA
Telephone: +1 202-289-0222
Fax: +1 202-289-7722
ITE on the Web: www.ite.org

Sponsored by:



Office of Infrastructure
Federal Highway Administration
1200 New Jersey Ave., SE
Washington, DC 20590

Office of Planning,
Environment and Realty
Federal Highway Administration
1200 New Jersey Ave., SE
Washington, DC 20590



Office of Sustainable Communities
U.S. Environmental Protection Agency
1200 Pennsylvania Ave, NW
Ariel Rios Building
Washington, DC 20460

Notices:

This document is disseminated under the sponsorship of the Department of Transportation in the interest of information exchange. The U.S. Government assumes no liability for its contents or the use thereof. This report does not constitute a standard, specification, or regulation. The U.S. Government and ITE do not endorse products or manufacturers. Trade and manufacturers' names appear in this report only because they are considered essential to the object of the document.

This project was partially funded by a cooperative agreement from the Environmental Protection Agency's Office of Sustainable Communities.

Publication No. RP-036A
© 2010 Institute of Transportation Engineers. All rights reserved.
1000/GP/BH/0310

Printed in the United States of America
ISBN-13: 978-1-933452-52-4
ISBN-10: 1-933452-52-8

Preface and Acknowledgments

Designing Walkable Urban Thoroughfares: A Context Sensitive Approach, RP-036A was approved in 2010 as a recommended practice of the Institute of Transportation Engineers (ITE). It supersedes the proposed recommended practice, *Context Sensitive Solutions in Designing Major Urban Thoroughfares for Walkable Communities*, RP-036, dated March 2006. The comment period on the proposed recommended practice closed on December 31, 2006. Comments on the proposed recommended practice have been incorporated into this document.

ITE wishes to thank the Federal Highway Administration's Office of Infrastructure, Office of Planning, Environment and Realty and the Environmental Protection Agency's Office of Sustainable Communities for financially supporting this work effort and providing leadership and guidance in the development of this report.

This report was produced by ITE and the Congress for the New Urbanism (CNU) and is the result of several years of concerted effort by dedicated volunteers, including ITE members, CNU members and many other interested parties. ITE wishes to thank the members of each of the following committees for their respective roles in the preparation of this report.

The project management team played an essential role in the identification, development and refinement of content, including numerous detailed reviews throughout the development process. The members of the project management team were as follows:

Brian S. Bochner (H), Texas Transportation Institute
Philip J. Caruso (F), ITE
James M. Daisa (F), Kimley-Horn and Associates, Inc.
Lisa M. Fontana Tierney (F), ITE
Lucinda E. Gibson (M), Smart Mobility Inc.
John Norquist, CNU
Jon T. Obenberger (M), FHWA
Harold E. Peaks, FHWA
Heather Smith, CNU
John V. Thomas, EPA
Neel Vanikar, FHWA

A multidisciplinary steering committee, including a policy and technical advisory committee, was responsible for general project oversight. The policy advisory committee was responsible for providing overall vision and direction, while the technical advisory committee provided guidance and review of technical content. The members of the policy and technical advisory committees were as follows:

POLICY ADVISORY COMMITTEE

Frances Banerjee
Andres Duany
Philip A. Erickson (M)
R. Marshall Elizer Jr. (F)
Hal Kassoff (M)
Kenneth F. Kobetsky (M)
Tim Torma

TECHNICAL ADVISORY COMMITTEE

Chester E. Chellman (F)
Frederick C. Dock (F)
Norman W. Garrick
Ellen Greenberg
Richard A. Hall (F)
Rodney W. Kelly (F)
John N. LaPlante (F)
Marcy McInelly
Danny C. Pleasant (F)
Peter Swift
Jeffrey Tumlin

This report was balloted and approved by a committee of individuals actively involved in the development of the report. The voting committee members included the following:

R. Marshall Elizer Jr. (F)
Norman W. Garrick
Richard A. Hall (F)
Rodney W. Kelly (F)
John N. LaPlante (F)
Danny C. Pleasant (F)
Peter Swift
Jeffrey Tumlin

Endorsement for publication of this document as an ITE recommended practice was provided by a recommended practice review panel consisting of the following individuals with an active interest and knowledge of context sensitive design. The following individuals were members of the panel:

Raymond E. Davis III (F)
Cesar J. Molina Jr. (M)
Brian L. Ray
Dennis E. Royer (M)
Dean A. Schreiber
Nikiforos Stamatidis (F)

A consultant team, led by James M. Daisa and Brian S. Bochner, was responsible for creating and assembling all technical content. These efforts included development of the report's organizational structure; identification, research and development of examples; and compilation, evaluation and incorporation of numerous comments in concert with direction provided by the project management team. The consultants and their respective companies were as follows:

KIMLEY-HORN AND ASSOCIATES INC.

James M. Daisa (F), Co-Project Manager

Roger B. Henderson (F)	Deborah K. Fehr (M)
John Martin	Patrick Ramos
Bruce E. Friedman (F)	Michelle M. Olmsted
Frederick W. Schwartz (F)	Luke J. Schwartz (M)
Andrew Howard	Lynne B. Filson (F)
Ali Mustafa	Katherine Falk (M)
Toni Barela	Jeff Smith

TEXAS TRANSPORTATION INSTITUTE

Brian S. Bochner (H), Co-Project Manager
Beverly J. Storey

COMMUNITY, DESIGN + ARCHITECTURE

Philip A. Erickson (M)

Thomas Kronemeyer	Sam Zimbabwe
Kendra Mitchell	Evelyn O'Donohue
Kyla Burson	

CITY OF PASADENA DEPARTMENT OF TRANSPORTATION

Frederick C. Dock (F)

UNIVERSITY OF UTAH

Reid H. Ewing

Additional technical reviewers and commentators of draft versions of this report included the following individuals:

Bruce Appleyard	Timothy T. Jackson
William R. Balentine	Robert P. Jurasin (F)
Timothy S. Bochum (M)	Joanna M. Kervin (F)
Scott Bradley	Tom Kloster (M)
Robert H. Brakman (F)	Walter M. Kulash
Bob Bryant	John Lazarra
Dan E. Burden	Elizabeth MacDonald
Peter Calthorpe	Joel R. McCarroll
Jeff Caster	Michael D. Meyer (M)
Joseph C. Chester	Tracey Newsome
Payton Chung	Neal I. Payton
Edward H. Cole (M)	Matthew D. Ridgway (F)
Vivian D. Coleman (M)	Wilton A. Roberts
Stephen J. Cote	Otha J. Rogers (M)
Mike Davis	Bob Schlicht
Ron DeNadai	Samuel Seskin
Steven Elkins	Frank Spielberg (F)
Christopher V. Forinash	Harry W. Taylor (M)
Dan Gallegher	Lois E. L. Thibault
Toni Gold	Dennis R. Toomey (M)
Lewis G. Grimm (F)	Charles N. Ukegbu
DeLania L. Hardy	Jerry Walters
Keith Hines	Robert C. Wunderlich (F)
Dwight A. Horne	

(Letters in parentheses indicate ITE member grade: H- Honorary, A-Associate Member, M-Member, F-Fellow.)

Table of Contents

Part 1: Introduction

Chapter 1. Foundation.....	3
Purpose of This Report	3
CSS and This Report.....	3
Objectives of this Report	4
Walkable Communities	4
Applicability of this Recommended Practice	6
Relationship to Other Guidance.....	6
Organization.....	7
Who Should Use This Report	7
Works Cited.....	10
Sources of Additional Information	10

Part 2: Planning

Chapter 2. Planning and Developing Context Sensitive Urban Thoroughfares.....	13
Purpose.....	13
Objectives.....	13
CSS in the Transportation Planning Process.....	13
CSS in the Project Development Process	18
Sources of Additional Information	22
Chapter 3. Network and Corridor Planning.....	23
Purpose.....	23
Objectives.....	24
Introduction.....	24
CSS in Network Planning	24
Effective Network Planning for Walkable Areas.....	26
Urban Form and Transportation Networks.....	27
Planning Urban Transportation Networks.....	28
Network Planning Principles for Walkable Urban Thoroughfares	28
Network Design Guidelines	30
Urban Corridor Thoroughfare Planning for Walkable Urban Areas.....	32
CSS Example in Corridor Planning—Developing Evaluation Criteria	36
An Important Note About Implementation.....	39
Works Cited.....	40
Sources of Additional Information	41
Chapter 4. A Framework for Walkable Urban Thoroughfare Design	43
Purpose.....	43
Objectives.....	43
Introduction.....	43
Features that Create Context	44
Context Zones	47
Thoroughfare Types.....	48

Works Cited.....	53
Sources of Additional Information	53

Part 3: Design

Chapter 5: Thoroughfare Design Process	57
Purpose	57
Applicability of Design Criteria	57
Objectives.....	57
Definitions.....	57
Overview of the Design Process	59
Flexibility in Application of Design Criteria	63
Design Process in Constrained Right of Way	63
Works Cited.....	64
Chapter 6: Thoroughfare Designs for Walkable Urban Areas	67
Purpose.....	67
Objectives.....	67
Basis for Thoroughfare Design Examples.....	67
General Walkable Thoroughfare Design Parameters.....	67
Specialized Thoroughfare Designs.....	69
Traveled Way	73
Streetside	76
Intersections.....	76
Multiway Boulevards.....	77
Design Examples.....	81
Works Cited.....	105
Sources of Additional Information	105
Chapter 7: Design Controls	107
Purpose.....	107
Objectives.....	107
Introduction.....	107
Design Controls Defined by AASHTO	107
Differences from Conventional Practice	108
Thoroughfare Speed Management	111
Additional Controls to Consider in Thoroughfare Design	112
Works Cited.....	113
Sources of Additional Information	114
Chapter 8: Streetside Design Guidelines.....	115
Purpose.....	115
Objectives.....	115
Introduction.....	115
The Urban Streetside: Uses and Activities.....	116
Design Principles	116
Design Guidance	119
Streetside Width and Functional Requirement.....	120
Edge Zone Principles and Considerations.....	120

Furnishings Zone Principles and Considerations	122
Throughway Zone Principles and Considerations	123
Frontage Zone Principles and Considerations	123
Driveway Crossing Principles and Considerations	125
Recommended Practice	125
Additional Guidelines	125
Justification	129
Works Cited	129
Sources of Additional Information	129
Chapter 9. Traveled Way Design Guidelines	131
Purpose	131
Objectives	131
Introduction	131
Design Considerations	132
Design Guidance	136
Lane Width	136
Background and Purpose	136
General Principles and Considerations	136
Recommended Practice	137
Medians	138
Background and Purpose	138
General Principles and Considerations	139
Recommended Practice	140
Additional Guidelines	140
Trees and Landscaping in Medians	140
Justification	142
Bicycle Lanes	143
Background and Purpose	143
General Principles and Considerations	143
Recommended Practice	145
Justification	145
On-Street Parking Configuration and Width	145
Background and Purpose	145
General Principles and Considerations	146
Recommended Practice	147
Additional Guidelines	148
Justification	148
Geometric Transition Design	148
Background and Purpose	148
Recommended Practice	149
Additional Guidelines	149
Four-Lane to Three-Lane Conversions (Road Diets)	149
Midblock Crossings	150
Background and Purpose	150
General Principles and Considerations	150
Recommended Practice	152
Justification	152
Pedestrian Refuge Islands	156

Background and Purpose	156
General Considerations	156
Recommended Practice	157
Justification	157
Transit Design	157
Background and Purpose	157
Types of Transit on Thoroughfares	158
Transit Facilities on Thoroughfares	158
Planning for Transit	160
Bus Stops in the Traveled Way	163
Background and Purpose	163
General Principles and Considerations	163
Recommended Practice	165
Justification	168
Special Consideration with Stormwater Management	168
Background and Purpose	169
General Principles	170
Guidelines	170
Recommended Practice	171
Justification	171
Special Consideration with Snow Removal	171
Background and Purpose	171
Recommended Practice	172
Works Cited	172
Sources of Additional Information	172
Chapter 10. Intersection Design Guidelines	175
Introduction	175
Objectives	176
Design Elements for Intersections in Walkable Areas	180
Design Guidance	180
Intersection Geometry	180
General Intersection Layout	182
General Principles and Considerations	184
Curb Return Radii	184
Background and Purpose	184
General Principles and Considerations	185
Recommended Practice	186
Justification	187
Channelized Right-Turns	187
Background and Purpose	187
General Principles and Considerations	188
Recommended Practice	188
Modern Roundabouts	190
Background and Purpose	190
General Principles and Considerations	190
Recommended Practice	192
Justification	192
Pedestrian Treatments at Intersections—Crosswalks	193

Background and Purpose	193
General Principles and Considerations	193
Recommended Practice	194
Justification	194
Curb Extensions	195
Background and Purpose	195
General Principles and Considerations	195
Recommended Practice	197
Justification	197
Bicycle Lane Treatment at Intersections	197
Background and Purpose	197
General Principles and Considerations	198
Recommended Practice	198
Justification	198
Bus Stops at Intersections	198
Background and Purpose	198
Recommended Practice	200
Works Cited.....	203
Sources of Additional Information	203
Appendix 1. Key Terms and New Concepts.....	205
Appendix 2. Introduction to Context Sensitive Solutions (CSS).....	211
What is CSS?	211
Why CSS is Important	212
Elements of Effective CSS	212
Conventional Process Versus CSS	214
CSS Principles, Processes and Outcomes.....	214

The background features a detailed architectural site plan in light gray, showing a central street with multiple lanes, sidewalks, and various building footprints. Several circular tree symbols are scattered throughout the plan. Overlaid on this plan are several black and white photographs of a city street scene. One photo shows a person walking a bicycle on a sidewalk. Another shows a person walking with a shopping cart. A third photo shows a street view with trees and a building. A fourth photo shows a building entrance with a sign that reads "EXIT REALTY", "EDEN AND FRIENDS", and "CITY PIZZA".

PART 1

Introduction

● 32 Vel
□ 16 Pec

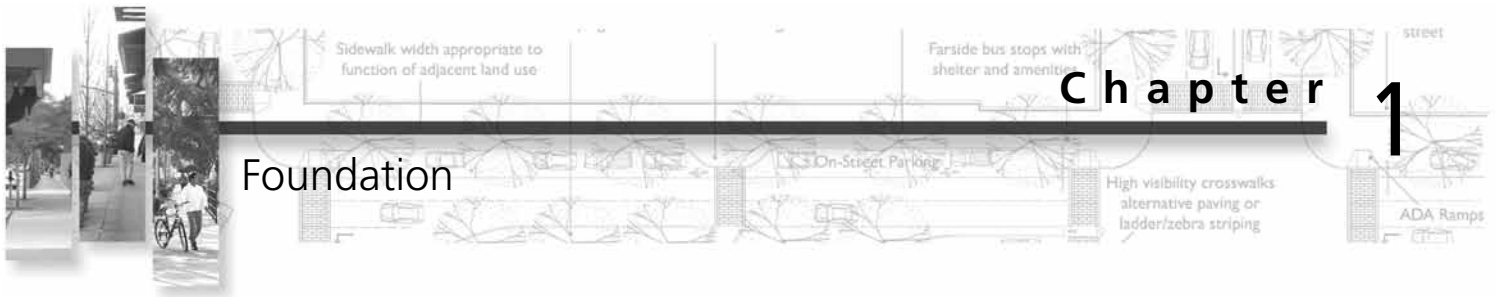

Foundation

Purpose of This Report

This report has been developed in response to widespread interest for improving both mobility choices and community character through a commitment to creating and enhancing walkable communities. Many agencies will work toward these goals using the concepts and principles in this report to ensure the users, community and other key factors are considered in the planning and design processes used to develop walkable urban thoroughfares.

Traditionally, through thousands of years of human settlement, urban streets have performed multiple functions. Mobility was one of the functions, but economic and social functions were important as well. Retail and social transactions have occurred along most urban thoroughfares throughout history. It is only in the 20th century that streets were designed to separate the mobility function from the economic and social functions. This report is intended to facilitate the restoration of the complex multiple functions of urban streets. It provides guidance for the design of walkable urban thoroughfares in places that currently support the mode of walking and in places where the community desires to provide a more walkable thoroughfare, and the context to support them in the future.

While the concepts and principles of context sensitive solutions (CSS) are applicable to all types of transportation facilities, this report focuses on applying the concepts and principles in the planning and design of urban thoroughfares—facilities commonly designated by the conventional functional classifications of arterials and collectors. Freeways, expressways and local streets are not covered in this report. The following chapters emphasize thoroughfares in “walkable communities”—compact, pedestrian-scaled villages, neighborhoods, town centers, urban centers, urban cores and other areas where walking, bicycling and transit are encouraged. Practitioners working on places and thoroughfares that do not completely fit within this

report’s definition of walkable urban thoroughfares may also find this guidance useful in gaining an understanding of the flexibility that is inherent in the “Green Book”—the American Association of State Highway and Transportation Officials’ (AASHTO’s) *Policy on Geometric Design of Highways and Streets* (AASHTO, 2004a).

Throughout this report, for brevity, the terms “principles of CSS” and “CSS” are used interchangeably.

CSS and This Report

The principles of CSS promote a collaborative, multidisciplinary process that involves all stakeholders in planning and designing transportation facilities that:

- Meet the needs of users and stakeholders;
- Are compatible with their setting and preserve scenic, aesthetic, historic and environmental resources;
- Respect design objectives for safety, efficiency, multimodal mobility, capacity and maintenance; and
- Integrate community objectives and values relating to compatibility, livability, sense of place, urban design, cost and environmental impacts. (FHWA and Atlanta Regional Commission)

Applying the principles of CSS enhances the planning and design process by addressing objectives and considerations not only for the transportation facility but also for the surrounding area and its land uses, developments, economic and other activities and environmental conditions. With a thorough understanding of the CSS principles and design process, the practitioner planning or designing a thoroughfare seeks to integrate community objectives, accommodate all users and make decisions based on an understanding of the trade-offs

that frequently accompany multiple or conflicting needs.

Applying the principles of CSS in the transportation planning or project development process identifies objectives, issues and trade-offs based on stakeholder and community input starting at the regional planning process and continuing through each level of planning and project development (for example, network, corridor and project). This report provides guidance in how CSS principles may be considered and applied in the processes involved with planning and developing roadway improvements for walkable urban thoroughfares.

As documented in *Context-Sensitive Design Around the Country* (TRB 2004), *A Guide to Best Practices for Achieving Context Sensitive Solutions* (TRB 2002) and other sources, the principles of CSS are successfully used in towns and cities as well as in rural areas. Agencies are transforming the current project development process to meet the expectations of all users and stakeholders. Integrating CSS principles into the project development process results in the consideration of a broad range of objectives and an attempt to balance these objectives based on the needs and conditions specific to each project and its context. The use of CSS principles in the project development process is resulting in community interests, user needs and environmental issues being considered early in the development of roadway improvement projects—specifically in defining the project’s purpose and need and, as appropriate, in other decisions in each phase of the project.

Objectives of this Report

The objectives of this report are to

1. Identify how CSS principles can be applied in the processes (for example, network, corridor, project development) involved with planning and developing roadway improvement projects on urban thoroughfares for walkable communities;
2. Describe the relationship, compatibility and trade-offs that may be appropriate when balancing the needs of all users, adjoining land uses,

environment and community interests when making decisions in the project development process;

3. Describe the principles of CSS and the benefits and importance of these principles in transportation projects;
4. Present guidance on how to identify and select appropriate thoroughfare types and corresponding design parameters to best meet the walkability needs in a particular context; and
5. Provide criteria for specific thoroughfare elements, along with guidance on balancing stakeholder, community and environmental needs and constraints in planning and designing walkable urban thoroughfare projects.

Walkable Communities

Walkable communities are urban places that support walking as an important part of people’s daily travel through a complementary relationship between transportation, land use and the urban design character of the place. In walkable communities, walking is a desirable and efficient mode of transportation. Although nearly every human environment can accommodate some degree of walking, walkable communities give additional value and support to make walking an enjoyable experience (see sidebar regarding the “continuum of walkability”).

Principles for walkable communities include the following:

1. Accommodating pedestrians, bicycles, transit, freight and motor vehicles within a fine-grained urban circulation network where the allocation of right of way on individual thoroughfares is based on urban context, often determined through the process in this report;
2. Providing a compact and mixed-use environment of urban buildings, public spaces and landscapes that support walking directly through the built environment and indirectly by supporting human and economic activities associated with adjacent and surrounding land uses;
3. Achieving system-wide transportation capacity by using a high level of multimodal network connectivity, serving walkable commu-

nities with appropriately spaced and properly sized pedestrian, bicycle, transit and vehicular components rather than by increasing the vehicular capacity of individual thoroughfares; and

4. Creating a supportive relationship between thoroughfare and context by designing thoroughfares that will change as the surroundings vary in urban character.

Walkable communities have the following characteristics:

1. A mix of land uses in close proximity to one another;
2. A mix of density including relatively compact developments (both residential and commercial);
3. Building entries that front directly onto the sidewalk without parking between entries and the public right of way;
4. Building, landscape and thoroughfare design that is pedestrian-scale—in other words, that provides architectural and urban design features scaled and detailed to be appreciated by persons who are traveling slowly and observing from the sidewalk at street level;
5. Thoroughfares designed to serve the activities generated by the adjacent context in terms of the mobility, safety, access and place-making functions of the public right of way; and
6. A highly connected, multimodal circulation network, usually with a fine “grain” created by relatively small blocks providing safe, continuous and balanced multimodal facilities that capitalize on compact urban development patterns and densities.

The above principles and characteristics are the qualities found in urban places where development pattern, intensity and design combine to facilitate frequent walking and transit use. In these places, the nonauto modes are attractive and efficient choices for many people, in concert with automobiles and their convenient and accessible parking. An increasing number of communities are recognizing the value of these features and are embracing them in land use, urban design and transportation

Continuum of Walkability

At some level nearly every place in the built environment is walkable. Some places, such as freeways or highways do not allow for pedestrians. At the other extreme, public spaces such as plazas, parks and pedestrian malls are primarily for pedestrians and generally exclude vehicles. Thoroughfares that are in between these two extremes require trade-offs between pedestrian and vehicle priority. The focus of this report is on the thoroughfares that are “pedestrian supportive” as shown in the spectrum of pedestrian and vehicle supportiveness below. Some of the concepts in this report can be used in pedestrian-tolerant areas as well.

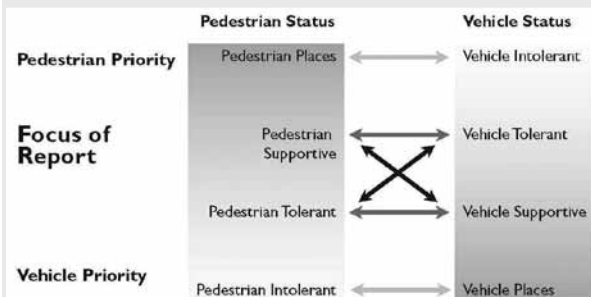

Pedestrian priority on urban thoroughfares falls into the following ranges:

- Pedestrian places—mixed-use areas with a significant pedestrian presence, not dominated by, and sometimes prohibiting, vehicles;
- Pedestrian supportive—mixed-use areas with moderate to significant pedestrian presence;
- Pedestrian tolerant—areas that minimally accommodate pedestrians but do not support a high level of pedestrian activity and are usually vehicle dominant; and
- Pedestrian intolerant—areas with little support for walking or that prohibit pedestrians and are vehicle dominant.

Thoroughfares that are pedestrian supportive range from being tolerant to supportive of vehicular access and mobility. The specifics of the community’s objectives, transportation needs and priorities are resolved through the CSS process to arrive at the proper thoroughfare design solutions.

Source: Adapted from a system for describing “degrees of walkability” for street environments, Charlier Associates.

plans, often using techniques drawn from planning and design movements such as smart growth and new urbanism.

As the successful design of walkable communities is complex and is not the primary focus of this report, the following references are provided as some of the many sources for useful guidance regarding the overall design of walkable communities:

1. *Promoting Sustainable Transportation Through Site Design: An ITE Recommended Practice*, 2010. This document provides specific guidance regarding the design of sites to create a context that supports walkable urban thoroughfares.
2. *SmartCode v9.2*, (Andres Duany, Sandy Sorlien, and William Wright, 2008). This document is a model development code for walkable communities that is based upon the Transect.

Applicability of this Recommended Practice

This recommended practice provides guidance for designing urban thoroughfares—facilities designated as arterials or collectors—to support walkable communities. Most applications of the design guidance included in this report will often apply in one of the following two circumstances:

1. A thoroughfare project in an existing walkable community where its multimodal character is to be preserved and enhanced; or
2. A thoroughfare project in an area where community goals call for a walkable context, in which case applying this design guidance will shape public investment to advance those goals.

Both circumstances can apply to either new construction or retrofit projects.

Commitment to walkable communities as a goal means that throughout the design process, location will serve as a design control (see Chapter 7). As a result, design decisions will consistently favor those elements and dimensions that are most supportive

of walkable community characteristics. Examples of the design-decision processes favoring walkable community outcomes are provided in Chapter 5.

Other development contexts will also benefit from applying the guidance presented in this report. These include places characterized by business parks, residential subdivisions and strip commercial development. In areas such as these, outside of existing and evolving walkable communities, this report can help designers provide benefits including

- Safe and comfortable facilities for pedestrians;
- Attractive streetside areas;
- Appropriate sizing of facilities with respect to pavement width, with associated potential for cost savings in right-of-way acquisition, construction and maintenance;
- Successful integration of transit facilities and operations; and
- Speed management.

In cases where the design guidance is being used in development contexts other than walkable communities (existing or planned), design controls other than location may dominate trade-off decisions.

Relationship to Other Guidance

This report supplements and expands on policies, guides and standards commonly used by state and local transportation, engineering and public works engineers and planners. Those publications include *A Policy on Geometric Design of Highways and Streets* (AASHTO 2004a); *Guide for the Planning, Design and Operation of Pedestrian Facilities* (AASHTO 2004b); *Guide for the Development of Bicycle Facilities* (AASHTO 1999); *Highway Safety Design and Operations Guide* (AASHTO 1997); *Roadside Design Guide* (AASHTO 2002); as well as state department of transportation design policies and manuals, local municipal street design standards, urban design guides and guidances published by other standard-setting organizations. This publication expands on information published by the Federal Highway Administration (FHWA) in *Flexibility in Highway Design* (1997) and the *Manual on Uniform Traffic Control Devices* (2009) and builds upon the considerations in devel-

oping context sensitive solutions described in *A Guide for Achieving Flexibility in Highway Design* (AASHTO 2004c). **This report is intended to illustrate how AASHTO guidance can be applied to roadway improvement projects to make them more compatible with community objectives and context in urban areas.**

The flexibility encouraged in this report is consistent with the policies and intent expressed in the American Association of State Highway and Transportation Officials' (AASHTO) *Policy on Geometric Design of Highways and Streets*. Most of the criteria in this report are based on AASHTO design criteria, and this report shows how the criteria can be applied to create context sensitive designs in places with the qualities of traditional urbanism. This report presents guidance from sources other than AASHTO, citing these sources at the end of each chapter. This report incorporates by reference consistency with guidelines and standards published in the latest version of the *Americans with Disabilities Act Accessibility Guidelines* (ADAAG) as well as the *Public Rights-of-Way Accessibility Guidelines* (PROWAG), which both can be found at www.access-board.gov.

This report augments information found in the above resources by providing guidance on

1. Applying CSS principles in the planning and design of urban thoroughfares;
2. Considering a broader set of factors during the planning and design of walkable urban thoroughfares;
3. Recognizing the importance of context, the role of sites and buildings and how context influences the design of the thoroughfare and vice versa; and
4. Providing an understanding of how thoroughfare design criteria should vary depending on the context through which the thoroughfare passes.

Organization

This report is divided into three parts: introduction, planning and design. There are ten chapters:

- Chapter 1 provides the introduction.
- Chapters 2 through 4 describe how CSS principles are used in the planning and project development processes.
- Chapters 5 through 10 address the thoroughfare design process and specific design criteria.
- The appendices contain definitions of key terms and concepts, as well as a primer on CSS.

Table 1.1 lists the chapters and provides an overview of the material that is addressed in each chapter.

Chapter 6 provides general design parameters and example designs for urban thoroughfares with speeds up to 35 mph in areas with high levels of pedestrian, bicycle and transit activity. Chapter 7 presents general design controls that apply to urban thoroughfare design. Design guidelines in Chapters 8 through 10 focus on the streetside, traveled way and intersection design of lower-speed thoroughfares, but much of this guidance also can be applied to higher-speed facilities.

Who Should Use This Report

This report is for practitioners and stakeholders involved in planning and designing urban thoroughfares for walkable communities. Users are encouraged to consider the principles and guidelines in this report in conjunction with applicable local policies and manuals. **Table 1.2** presents many of the intended users and their responsibilities where CSS principles may be considered. Each user listed in **Table 1.2** represents a different set of stakeholders that bring different perspectives and responsibilities to the transportation planning and project development processes to best meet the needs of all the stakeholders. However, all users may benefit from an understanding of CSS principles and how they might be integrated into their work.

Table 1.1 Contents of This Report

Chapter Title	Material that is Addressed
Part 1: Introduction	
1—Foundation	The background behind this guidance and an overview of the principles of CSS.
Part 2: Planning	
2—Planning and Developing Context Sensitive Urban Thoroughfares	An overview of the transportation planning and project development process and how CSS principles are applied with these processes.
3—Network and Corridor Planning	An overview of thoroughfare network types, characteristics of successful networks and network design guidelines. An overview of the corridor planning process and the role of CSS.
4—A Framework for Walkable Urban Thoroughfare Design	An introduction into the design framework for context sensitive thoroughfare design, context zones, their characteristics and the features that create context and a description of thoroughfare types and their relationship with functional classifications, compatibility with context zones and general design parameters.
Part 3: Design	
5—Thoroughfare Design Process	A process for using this report to design thoroughfares, how to design thoroughfares within constrained rights of way and flexibility in the application of design criteria.
6—Thoroughfare Designs for Walkable Urban Areas	General design parameters for thoroughfare types, variations in the street-side and traveled way under varying conditions and example thoroughfare designs.
7—Design Controls	A discussion of the engineering controls and level of flexibility critical in context sensitive design, including design vehicle, roadway geometrics and design speed.
8—Streetside Design Guidelines	General principles, design considerations and detailed guidance for the design of the elements that comprise the streetside.
9—Traveled Way Design Guidelines	General principles, design considerations and detailed guidance for the design of the elements that comprise the traveled way.
10—Intersection Design Guidelines	General principles, design considerations and detailed guidance for the design of the elements that comprise multimodal intersections.

Table 1.2 Intended Users and Responsibilities

User	Responsibilities
All Users	<ul style="list-style-type: none"> • Participate in preparing transportation plans; • Help establish community vision and project goals and objectives; and • Help develop and evaluate thoroughfare concepts, alternatives and impacts.
Transportation Planner	<ul style="list-style-type: none"> • Develops and evaluates long-range transportation plans; • Helps establish community vision and project goals and objectives; • Develops and evaluates thoroughfare concepts, alternatives and impacts; and • Works with public, stakeholders and multidisciplinary teams to integrate transportation and land use planning.
Traffic/Civil Engineer	<ul style="list-style-type: none"> • Prepares purpose and need for transportation projects; • Develops initial thoroughfare concepts and prepares detailed evaluations of these concepts; • Identifies design controls and parameters, constraints and trade-offs; • Works with public, stakeholders and multidisciplinary teams to resolve design challenges; and • Prepares preliminary and final engineering plans.
Land Use Planner	<ul style="list-style-type: none"> • Develops long-range land use plans; • Helps establish community vision and goals and objectives for neighborhoods and corridors; • Works with multidisciplinary team to establish and identify context; • Formulates land use policy that affects thoroughfare design; and • Establishes land use regulations (subdivision, zoning and so forth) that guide context.
Design Professional - Architect - Urban Designer - Landscape Architect	<ul style="list-style-type: none"> • Designs integral elements of the thoroughfare and its surrounding context including buildings, sites and streetscape features; • Works with public, stakeholders and multidisciplinary teams to resolve design challenges; and • Prepares environmental assessments; identifies impacts and mitigation measures.
Stakeholders - Elected Officials - Appointed Commissioners - Developers - Local, Regional and State Agencies - Citizens	<ul style="list-style-type: none"> • Provide local and regional input and leadership; • Provide funding and financing mechanisms for development of context and thoroughfares; • Have jurisdiction and approval authority over plans and designs; and • Work closely with the general public to achieve community acceptance of projects.

Works Cited

American Association of State Highway and Transportation Officials. 1997. *Highway Safety Design and Operations Guide*. Washington, DC: AASHTO.

American Association of State Highway and Transportation Officials. 1999. *Guide for the Development of Bicycle Facilities*. Washington, DC: AASHTO.

American Association of State Highways and Transportation Officials. 2002. *Roadside Design Guide*. Washington, DC: AASHTO.

American Association of State Highway and Transportation Officials. 2004a. *Policy on Geometric Design of Streets and Highways*, Fifth Edition. Washington, DC: AASHTO.

American Association of State Highway and Transportation Officials. 2004b. *Guide for the Planning, Design and Operation of Pedestrian Facilities*. Washington, DC: AASHTO.

American Association of State Highways and Transportation Officials. 2004c. *A Guide for Achieving Flexibility in Highway Design*. Washington, DC: AASHTO.

Federal Highway Administration and Atlanta Regional Commission. Accessible via www.fhwa.dot.gov/context/index.cfm.

Federal Highway Administration. 1997. *Flexibility in Highway Design*. Washington, DC: FHWA.

Federal Highway Administration. 2009. *Manual on Uniform Traffic Control Devices*. Washington, DC: FHWA.

Federal Highway Administration. 2005. *Executive Order 13274—Purpose and Need Work Group Baseline Report*, March 15. Washington, DC: FHWA.

Institute of Transportation Engineers. 2010. *Promoting Sustainable Transportation Through Site Design: An ITE Recommended Practice*. Washington, DC: ITE.

Transportation Research Board. 2002. NCHRP Report 480: *A Guide to Best Practices for Achieving Context Sensitive Solutions*. Washington, DC: TRB.

Transportation Research Board. 2004. “Context Sensitive Design Around the Country, Some Examples.” *Transportation Research Circular Number E-CO67*—July. Washington, DC: TRB.

U.S. Architectural and Transportation Barriers Compliance Board. 1999. *Accessible Rights-of-Way: A Design Guide*.

Sources of Additional Information

Transportation Research Board. 2004. NCHRP 69: *Performance Measures for Context Sensitive Solutions—A Guidebook for State DOTs*. [NCHRP Web-Only Document 69 (Project 20-24(30)).] Washington, DC: TRB.

PART 2

Planning

● 32 Vel
□ 16 Pec

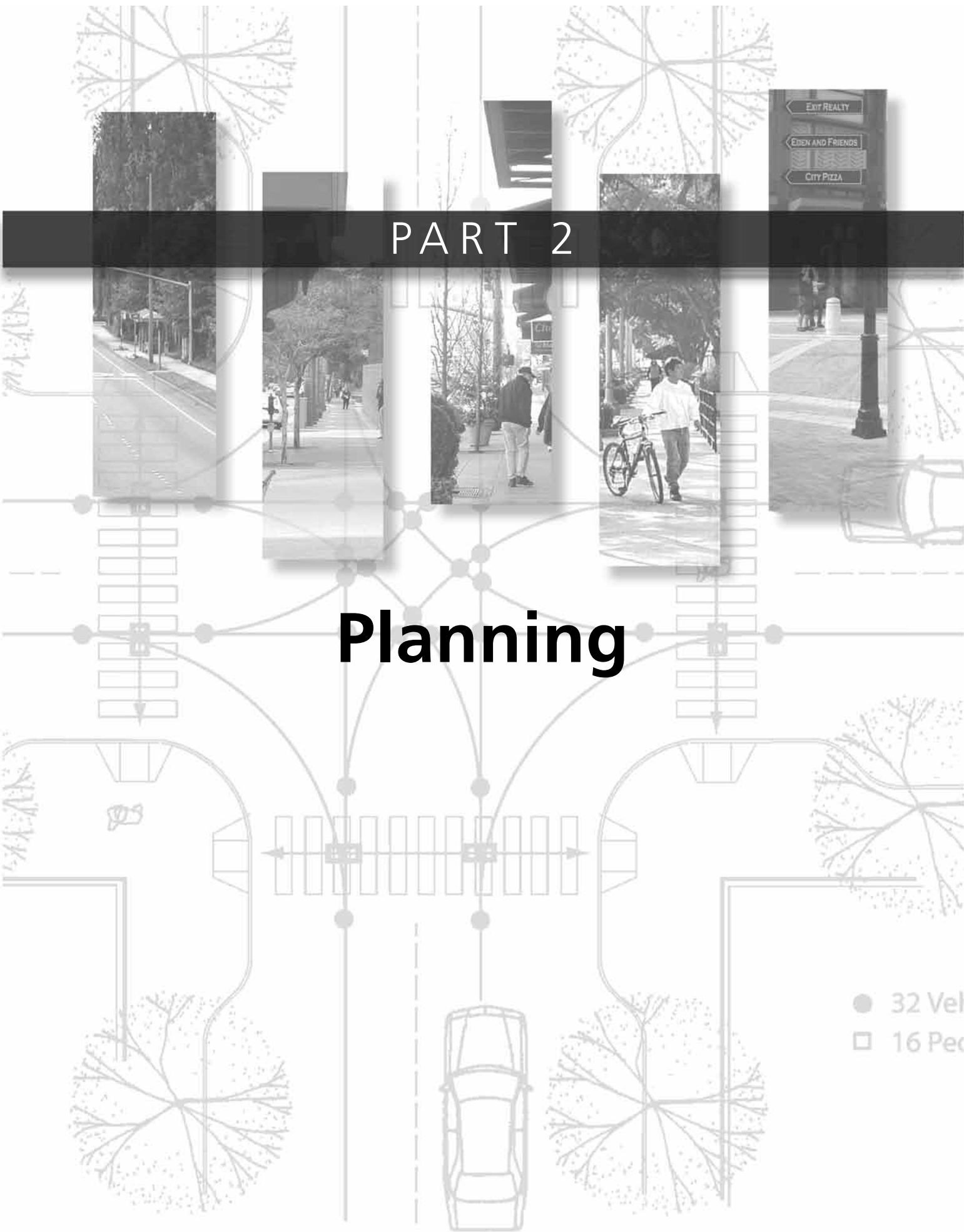



Purpose

This chapter describes, in general terms, the transportation planning and project development processes. It provides a broad overview of each stage of the processes and emphasizes that CSS principles can be applied at each stage. The transportation planning overview in this chapter provides the background for the practitioner to understand the principles and guidance on network and corridor planning presented in Chapter 3. Similarly, the overview of the project development process introduces the stages for planning and designing roadway improvement projects, which supports the information presented in Chapters 4 through 10.

Objectives

This chapter

1. Broadly describes how CSS principles can be integrated into the transportation planning process; and
2. Describes how CSS can be integrated into the project development process and identifies the applicable steps.

CSS in the Transportation Planning Process

Transportation planning is a continuing, comprehensive and collaborative process to encourage the development of a multimodal transportation system to ensure safe and efficient movement of people and goods while balancing environmental and community needs. The process is designed to promote involvement by all levels of government, stakeholders and the general public. The transportation planning process is concentrated at four levels of government: federal, state, metropolitan, or regional, and local agency. **Table 2.1** describes the planning roles and responsibilities at the various government levels and shows how CSS can be applied at each level.

The planning process examines demographic characteristics and travel patterns for a given area, shows how these characteristics will change over a given period of time and evaluates alternative improvements for the transportation system. **Table 2.1** also summarizes how CSS can be applied in each of the planning tiers. The planning tiers are divided into four levels:

1. National—Responsible for legislation and oversight and development of policies and regulations, as well as providing funding for transportation projects at the state, regional and local level.
2. Statewide—Responsible for long- and short-range transportation planning, development of transportation regulations and standards, oversight and development of transportation programs, transportation funding and implementation, and maintenance and operation of the state highway system.
3. Metropolitan or Regional—Responsible for areawide planning, projections and coordination; generally these agencies are metropolitan planning organizations (MPOs) in urbanized areas with more than 50,000 population or cover rural and small city regions outside the MPO areas. MPOs also coordinate metropolitan plan adoption, project selection and allocation of federal and some state funding.
4. Local Agency—Responsible for local planning and project development, operations and maintenance of transportation facilities.

The consideration of CSS principles can allow the different agency planning-level goals and objectives to be reflected in the initial or early development of individual projects and may convey information for use in defining the purpose and need. In addition, CSS considerations in transportation planning can identify issues or decisions facing the region, allowing for consensus and a shared understanding of the major sources of change that affect the future.

Table 2.1 Transportation Planning Tiers and CSS Applications

Tier	Responsibilities	CSS Applications
National	<ul style="list-style-type: none"> • Authorizing legislation • Federal regulations • Federal policy • Research programs • Highway construction funding 	<ul style="list-style-type: none"> • Interpreting legislation • Federal policy and regulations • Development of CSS and flexible design guidance • Demonstration projects • Research programs addressing design issues
Statewide	<p>Statewide State DOT Long-Range Planning (10 to 50 Years)</p> <ul style="list-style-type: none"> • Strategic plans • Transportation plans • Plans and programs <p>Programs and System Plans (5 to 10 Years)</p> <ul style="list-style-type: none"> • System and corridor planning • Strategic system plans • Regional/agency operational programs and plans • State transportation improvement programs (STIP) • Highway construction funding 	<ul style="list-style-type: none"> • Network design and connectivity plans • Multimodal and CSS policies • Public participation in CSS vision and plan development • Developing CSS and flexible design guidance • State design manual revisions • Context sensitive designs of highways and thoroughfares • Coordination with resource agencies • Demonstration programs • Staff and local agency training • CSS funding partnerships
Regional/Metropolitan	<p>Regional Long-Range Planning (10 to 50 Years)</p> <ul style="list-style-type: none"> • Agency strategic plans • Regional transportation plans • Agency plans and programs <p>Programs and System Plans (5 to 10 Years)</p> <ul style="list-style-type: none"> • System and corridor planning • Strategic system plans • Agency and regional transportation improvement programs (TIPs) • Transportation construction funding, coordination and prioritization 	<ul style="list-style-type: none"> • Network design and connectivity plans • Multimodal and CSS policies • Context sensitive highway and thoroughfare corridor studies • Coordinating among agencies • Staff and local agency training • CSS funding partnerships
Local Agency	<ul style="list-style-type: none"> • Operations, management strategies and plans • Roadway improvement projects • Planning, design and enhancements • Support services • Capital improvement programs 	<ul style="list-style-type: none"> • Local design manual/standards • Corridor plans • Thoroughfare plans • Multimodal and CSS policies in comprehensive plans • Integrating CSS into project development process (includes public participation)

Source: Adapted from *Freeway Management and Operations Handbook*, Federal Highway Administration

Integrating CSS principles within the transportation planning process assists regions and communities in reaching their transportation goals by encouraging the consideration of land use, transportation and infrastructure needs in an integrated manner. When transportation planning reflects community input and takes into consideration the impacts on both natural and human environments, it also promotes partnerships that lead to “balanced” decision making. Incorporating CSS considerations within transportation planning also produces better environmental results by advancing the ability to identify sensitive environmental resources while facilitating cooperative interagency relationships.

The benefits of integrating CSS in the planning process encourages public support for transportation plans and cooperation among agencies, reduces project delays by minimizing controversy and saves time and funds. CSS also fosters conservation of environmental and community resources. The probable benefits when working collaboratively with stakeholders includes the production of a full range of options, an understanding of trade-offs and consensus on key decisions. This results in information that directly feeds into, and accelerates the project development process.

Without adoption and support of CSS principles by agencies (for example, policies, procedures, standards and programs), it will be challenging and difficult to apply CSS in either a transportation planning process or improvement project. If a regional long-range transportation plan or local corridor plan has not incorporated a process that considers CSS, it may limit the range of options and the best overall solution. For example, changing the functional classification of a roadway to be more compatible with its surroundings should be considered at the level of the long-range transportation plan so that the change can be evaluated within the context of the entire network. Without a large-scale evaluation and adoption of the change in a plan, it will be difficult to change the functional classification at the project development stage, even if conditions justify the change.

Complete Streets

Some communities have adopted “complete streets” laws and policies to ensure that their roads and streets are routinely designed and operated to provide the safest achievable access for all users, including motorists, bicyclists, pedestrians and transit riders. In communities with complete streets policies, the objective is for pedestrians, bicyclists, motorists and transit riders of all ages and abilities to be able to safely move along and across an urban street.

A complete streets policy creates a routine process for providing for all travel modes whenever a street is built, altered, or maintained. Such policies have been adopted at the state level in the United States (Oregon, California, Illinois, South Carolina and Virginia), by MPOs (Central Ohio, California Bay Area) and by local governments (Charlotte, NC; Sacramento, CA; Boulder, CO; and Chicago, IL).

Communities with street projects will benefit greatly from the application of CSS principles. The recommendations of this report can help communities implement complete streets policies.

While context sensitive solutions involve stakeholders in considering a transportation facility in its entire social, environmental and aesthetic context, complete street policies are a reminder that providing for safe travel by users of all modes is the primary function of the corridor. Under complete streets, basic accommodations for bicyclists, pedestrians, transit users and disabled travelers are necessities rather than optional items. All modes and users are important on all thoroughfares.

For more information on complete streets, visit www.completestreets.org.

The process usually involves the steps shown in **Figure 2.1**. The general process is introduced here to demonstrate how each stage provides an opportunity to integrate CSS principles, beginning with the first step in the process—developing a vision, goals and policies. Below is a brief discussion of each step and the possible outcomes when CSS is part of the process.

Vision and Goals: It is at this step that the overall vision and goals for how the transportation system shall be designed, built, operated and maintained is decided. Applying CSS principles, at this level

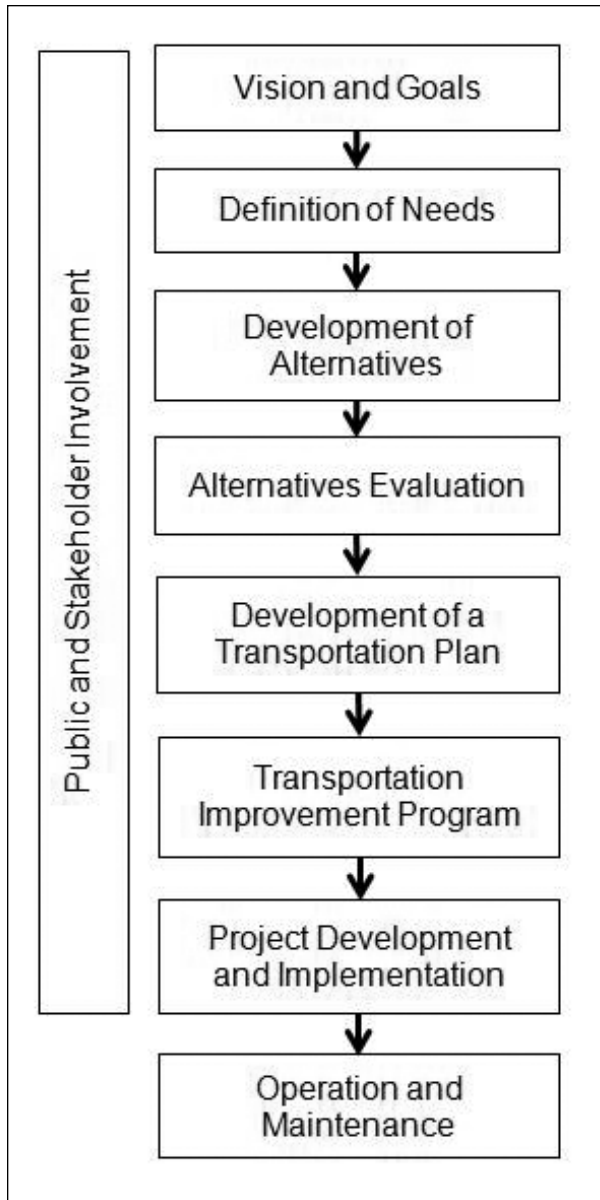

Figure 2.1 Transportation planning process.
Source: Kimley-Horn and Associates, Inc.

helps to integrate the regional, local and neighborhood vision for the physical nature and economic vitality of communities. CSS principles can result in compatibility between the facility and its surroundings so that the two are mutually supportive, whether in urban or rural settings. Possible outcomes of this step include:

- Long-range vision for the community and project;
- Community values and issues;
- Supporting data;

- Community and agency priorities;
- Development of a multidisciplinary team;
- Education of stakeholders regarding issues, process and constraints; and
- An established planning process that identifies decision points and stakeholder roles and responsibilities.

Definition of Needs: A process that incorporates CSS, inclusive of all stakeholders, can help define the needs of the transportation plan or project based on the goals, objectives and visions established earlier. By proactively identifying stakeholder values, issues and concerns, CSS allows development of an inclusive problem/need statement consistent with applicable policies and requirements. The possible outcomes of this step include:

- Acceptance of a problem statement that reflects community and agency perspectives;
- A broad and comprehensive needs statement reflecting community values as well as the transportation need; and
- Evaluation criteria and performance measures.

Development of Alternatives: CSS encourages use of the vision, goals and needs as the basis for developing a full range of options in a collaborative and participatory process, resulting in flexible and innovative solutions. Objectivity in developing the alternatives is critical. What seem at first sight to be infeasible options often can be refined into workable solutions. The possible outcomes of this step include:

- A full range of alternatives that meet the needs statement;
- Avoiding unlikely (straw man) alternatives;
- Opportunities for enhancement and flexibility to modify alternatives;
- Consideration of all modes and all users;
- Consideration of innovative and feasible solutions; and
- Clear, understandable and graphical portrayal of alternatives.

Alternatives Evaluation: CSS encourages objective evaluation of the trade-offs between different alterna-

tives, always relating back to evaluation criteria. As a result, stakeholders will be better able to support and endorse plans and designs. The possible outcomes of this step include:

- Participatory and transparent evaluation process;
- Clear assessment of trade-offs;
- Equal level of assessment for accurate comparison;
- Information to assist decision makers; and
- Clear reasoning behind rejection of alternatives.

Development of a Transportation Plan and Transportation Improvement Program (TIP): CSS principles can be integrated into the development of a long-term transportation network, with a goal of achieving increasingly diverse travel modes and improving the overall operation of the transportation system. As a strategy that enhances safety and encourages all travel modes, CSS projects (transportation enhancements) may draw upon different funding sources than do conventional projects. The possible outcomes of this step include a plan that:

- Reflects the vision and community values and meets the needs statement;
- Identifies opportunities to enhance community resources;
- Encompasses traditional and innovative solutions; and
- Engenders community ownership and endorsement.

Project Development and Implementation: CSS principles can have the most profound effect on this step in the planning and design process as transportation projects are taken from the conceptual stage to implementation. The possible outcomes of this step include:

- Innovative solutions that meet project needs, reflect community values and enhance resources;
- Expedited approval of projects through early and consistent stakeholder involvement;
- Application of design flexibility and documentation of design decisions;

Transportation Visioning

Communities determine their own vision for transportation—describing an ideal that reflects their values, concerns and priorities. Below are examples of a transportation vision from two communities.

“Moving people and goods within and across the metropolitan boundaries safely, conveniently and reliably by providing an integrated and accessible transportation system comprised of a balanced range of travel options.”

The Livable Metropolis, official plan of the Municipality of Metropolitan Toronto,

“Traffic in the corridors will be calmed to foster a relaxed, accessible, outdoor-oriented, pedestrian-friendly urban village. The issues outlined below expand upon the vision statement and become a set of principles to guide future public and private investment and also create a “measuring stick” by which to evaluate consistency with the vision, and thereby appropriateness, of these future investments:

- Slow the traffic;
- Divert cut-through traffic around Upper Arlington;
- Build safe crosswalks;
- Build sidewalks and bikeways;
- Plant more street trees; and
- Encourage redevelopment that is scaled to encourage/foster street life.

“100-year lifespan vision of Upper Arlington Streets”
Lane Avenue and Tremont Road
Street Planning and Transportation Vision, City of Upper Arlington, Ohio.

- Continuation of stakeholder input through design and construction; and
- Assurance that commitments made in the planning process are honored through construction.

Public and Stakeholder Involvement: CSS by definition is a process that involves, and attempts to build consensus among, a diverse group of stakeholders. The possible outcomes of this step include:

- Early involvement;
- A variety of traditional and innovative ways to engage the community (e.g., workshops, cha-

- rettes, newsletters, focus groups, Web sites, interviews);
- A high level of agency credibility and public trust throughout the involvement process;
- Engagement of underserved and minority communities;
- Equal participation of stakeholders; and
- Education of the public regarding the planning and project development processes, constraints and agency perspectives.

Operations and Maintenance: The transportation planning and project development processes consider the effects of decisions on costs, liability risks and operations and maintenance. Application of CSS principles and design guidance can affect these aspects of project development and need to be carefully considered. Examples include the need to maintain landscaping, the effects of CSS design on utility maintenance and liabilities associated with certain design elements in public places. The possible outcomes of this step include:

- Plans to monitor performance (particularly design exceptions) and receive feedback; and
- Commitment to maintain facilities.

CSS in the Project Development Process

Figure 2.2 combines the basic phases of the transportation planning and project development processes for transportation facilities involving federal funds. This figure illustrates how the transportation planning process relates to the project development process. The figure is intended to show how information for transportation improvements to a thoroughfare developed in the transportation process provides input into the project development process. This type of information includes:

- Multimodal role of thoroughfares within the network;
- Relationship between land uses and the transportation system;
- Travel demand forecasts for various modes of travel;

- Performance measures and criteria used to evaluate individual transportation projects;
- Multimodal performance of the network and individual corridors;
- Specific capital projects and funding sources;
- Goals and policies that provide direction for the development of individual transportation projects; and
- Prioritization of projects.

The information presented in this report requires an understanding of the existing and future context in urban areas. The application of CSS principles also requires one to know the ways to use the design of the thoroughfare itself to provide mutual support between the thoroughfare and existing and planned adjacent land uses and development patterns. While CSS principles should be considered at the highest level of planning and be integrated into the culture of transportation agencies, in project development, CSS principles should be introduced at the earliest stage—the needs study.

Integrating CSS in the project development process significantly influences the development of project concepts. Project concepts should emerge from a full understanding of the relationship between the thoroughfare, adjoining property and character of the broader urban area. Modal emphasis should be established in the early stages of project development, not addressed as an afterthought in preliminary engineering. In the project scoping or planning step, which includes an environmental review, all alternative analyses may incorporate the principles of CSS.

CSS highlights the need for context sensitive performance measures and criteria for selecting the preferred alternative at this stage of project development. The project development process in **Figure 2.2** illustrates where the information in this report can be used in the process. The steps discussed are highlighted in the flowcharts that follow (**Figures 2.3** through **2.6**):

- **Long-Range Transportation Plan:** In this part of the process, the report's network planning and design guidelines (Chapter 3) can be used to help prepare long-range transportation plans and network connectivity supporting context-based thoroughfares. Additionally, the thorough-

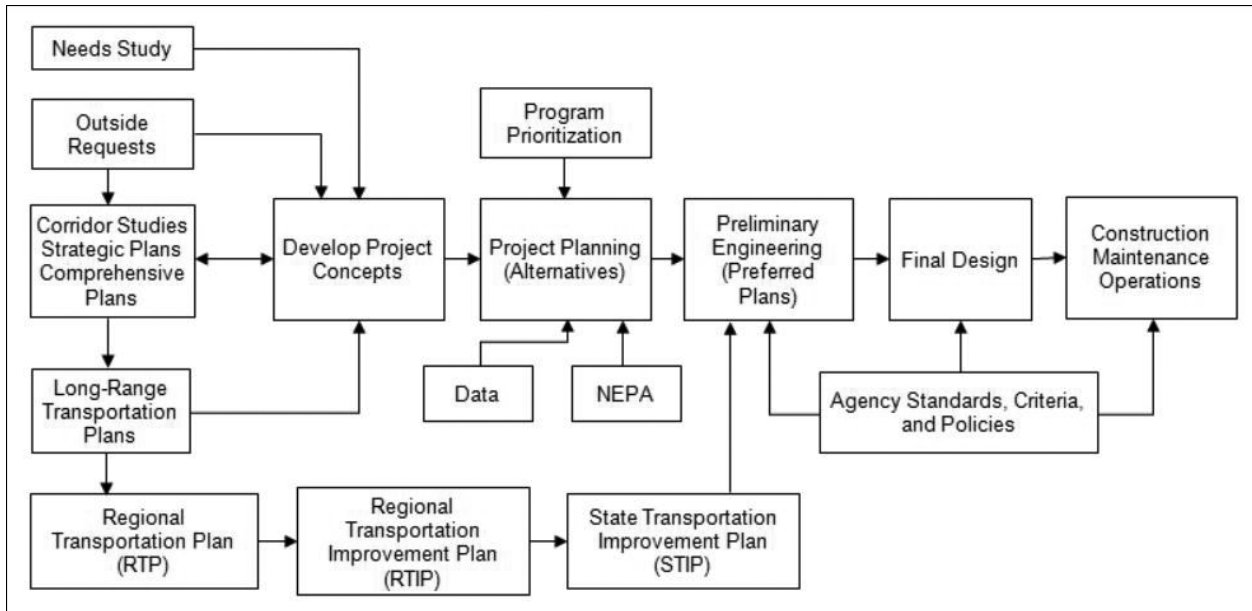

Figure 2.2 Transportation planning and project development processes. Source: Kimley-Horn and Associates, Inc.

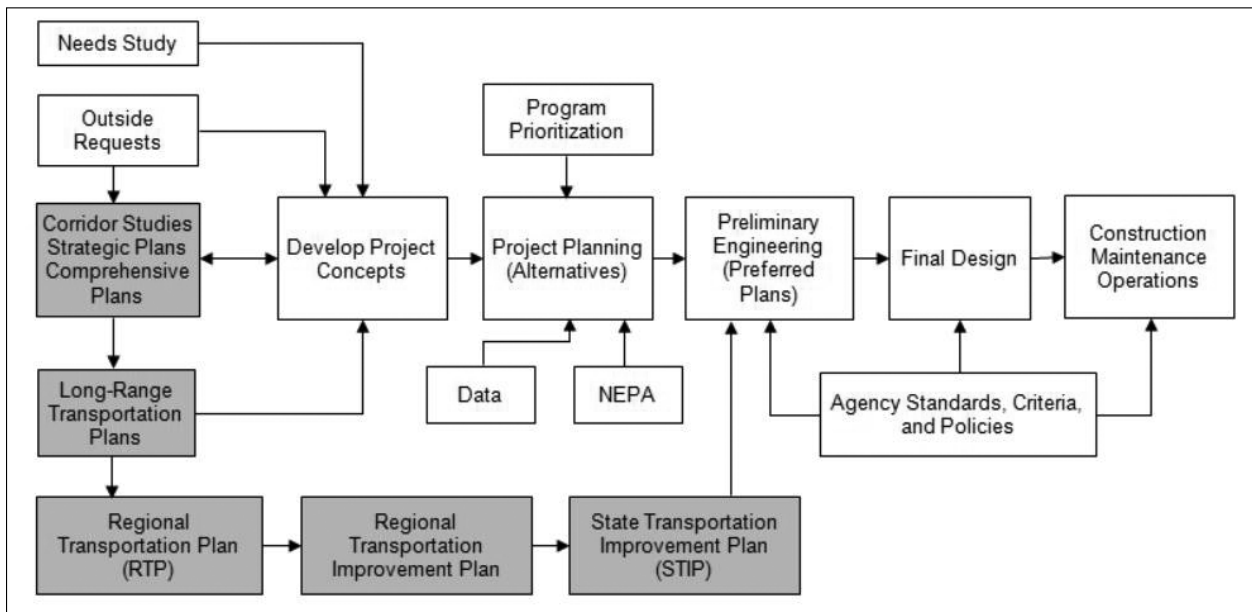

Figure 2.3 Applicable Steps in Planning Process for Long-Range Transportation Plan (shown as highlighted boxes)

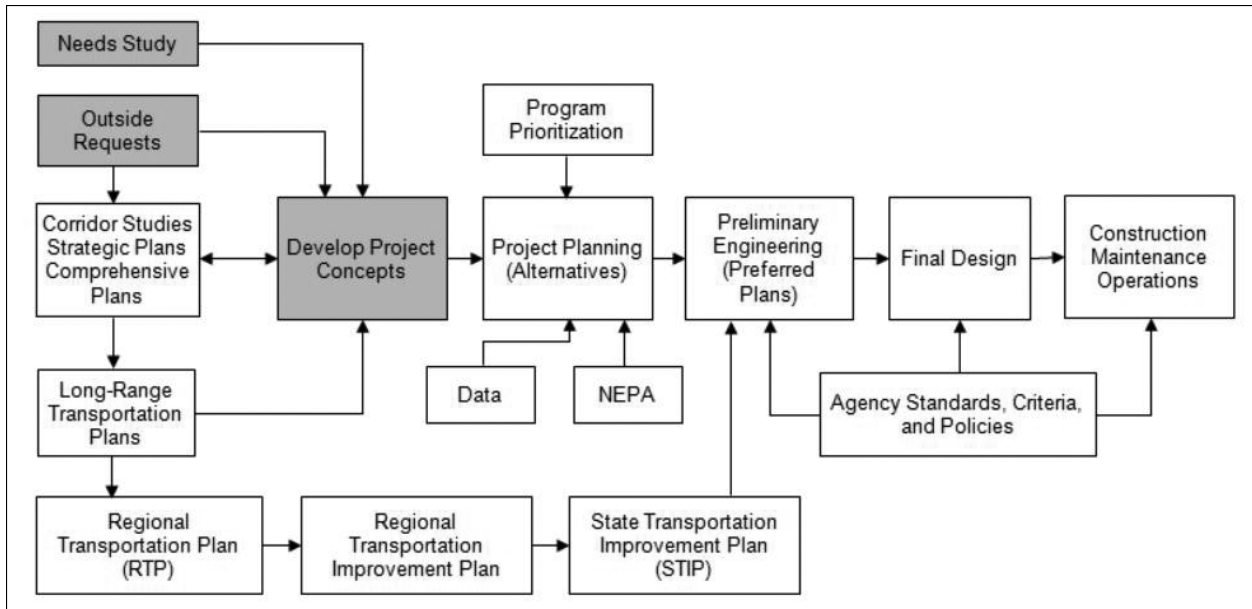

Figure 2.4 Applicable Steps in Planning Process for Needs Study and development of Project Concepts (shown as highlighted boxes)

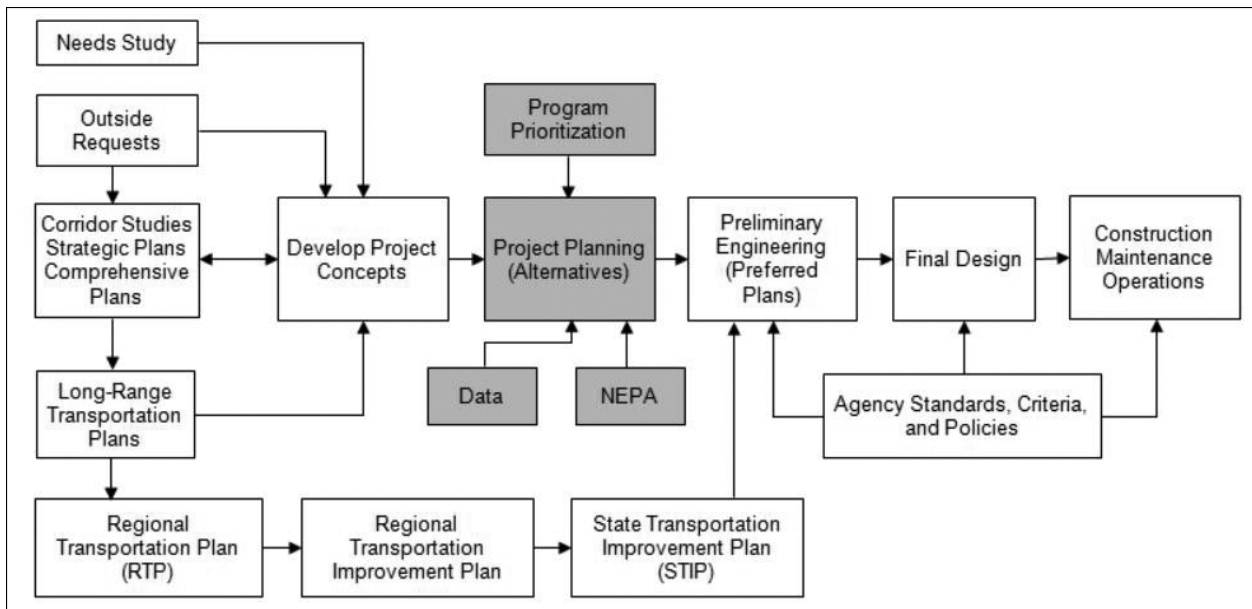

Figure 2.5 Applicable Steps in Planning Process for Project Planning and Alternatives Analysis (shown in highlighted boxes)

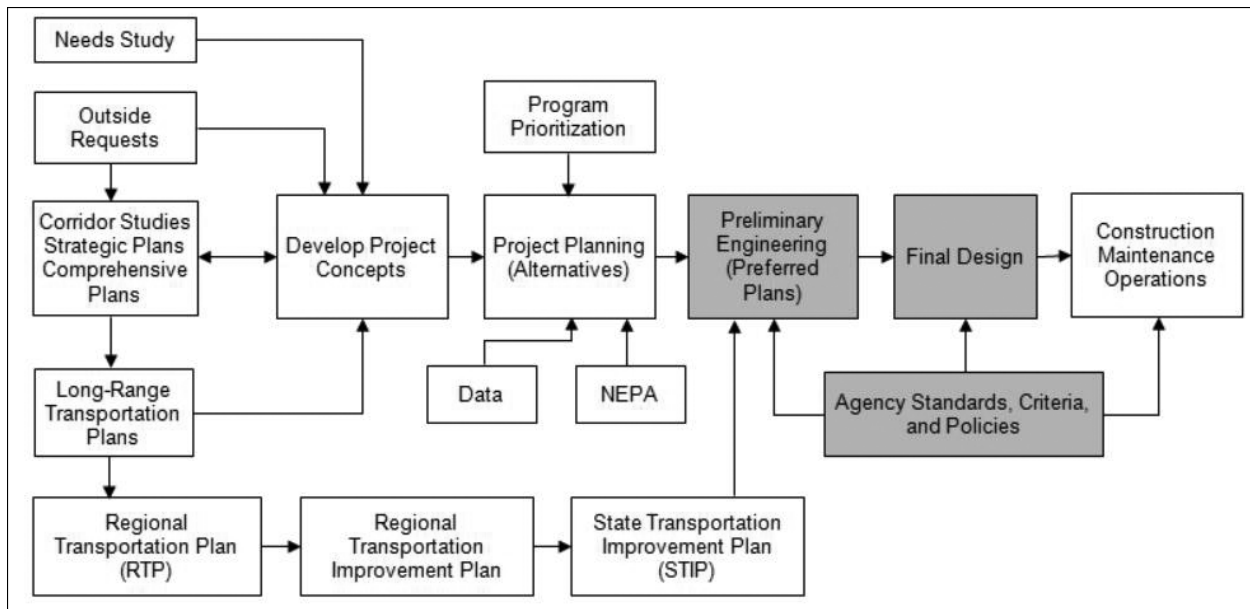

Figure 2.6 Applicable Steps in Planning Process for Preliminary Engineering and Final Design (shown in highlighted boxes)

fare types described in Chapter 4 may be integrated into the development of long-range plans. The long-range transportation planning process provides an opportunity to identify those places where local agency land use and development policies can best support urban CSS, such as pedestrian-scale districts, town center designs and transit corridors. These policy decisions can then be reflected in the development of thoroughfare classifications.

- **Needs Study and Project Concepts:** The fundamentals of urban context sensitive design, the design framework introduced in Chapter 3 and the thoroughfare design process and example thoroughfare designs (Chapters 5 and 6) are important tools in the needs study and development of project concepts. Multidisciplinary team and stakeholder involvement is critical in this early step.

The project concept will emerge from an understanding of the relationships between thoroughfare types and context zones, along with other unique project circumstances, values, or objectives. Additionally, a thoroughfare’s modal emphasis should be clearly identified in the project concept phase. Chapters 3 and 5 pro-

vide the tools for corresponding specific thoroughfare types to various contexts and describe how to prioritize design elements and assemble the cross sections based on context and potentially constrained conditions. Data input to the project concept phase of project development should include information relating to land use development patterns and design features that support present conditions and, equally important, the vision for the future context.

- **Project Planning and Alternatives Analysis:** Includes development and evaluation of alternatives and environmental review. The development of alternatives may use the techniques and design criteria presented in this report, including accessibility. Each alternative should incorporate the appropriate design characteristics compatible with the context.
- **Preliminary Engineering and Final Design:** The processes described in Part 3 of this report—thoroughfare design controls and detailed guidelines—are suitable tools for use in the preliminary engineering and final design phases of the project development process. These chapters provide information to establish an initial design for testing, identify trade-offs and prepare a final concept for engineering.

Sources of Additional Information

American Association of State Highway and Transportation Officials. 2004. *A Guide for Achieving Flexibility in Highway Design*. Washington, DC: AASHTO.

Ames, Steven C. 1998. *Guide to Community Visioning: Hands-On Information for Local Communities*. Washington, DC: APA Planners Press.

Federal Highway Administration. 1997. *Flexibility in Highway Design*. Washington, DC: FHWA.

Federal Highway Administration. 1996. *Public Involvement Techniques for Transportation Decision-Making*. Washington, DC: FHWA.

Transportation Research Board. 2002. "Going Public—Involving Communities in Transportation Decisions." Washington, DC: *TR News*, number 220.

Transportation Research Board. 2000. *How Transportation and Community Partnerships Are Shaping America: Part I: Transit; Part II: Streets and Roads*. NCHRP Project 20-7 Task 128. Washington, DC: AASHTO.

Transportation Research Board. 2002. NCHRP Report 480: *A Guide to Best Practices in Achieving Context Sensitive Solutions*. Washington, DC: TRB.



Purpose

This chapter describes the interrelationship between the broader transportation network, corridors and individual thoroughfare segments. It presents how the principles of CSS can be used in the planning for urban thoroughfares at the network, region, or corridor levels to support or create walkable places. Understanding this relationship will contribute to the consideration of key issues and community objectives and to the development of a broader set of alternatives and improved flexibility when planning and developing transportation improvement projects.

This chapter provides the network plan context from which transportation projects are selected for further development and design. The chapter is intended to provide background related to network planning, but other documents; such as the upcoming ITE *Planning Urban Roadway Systems* and the CNU Statement of Principles on Transportation Networks contain recommendations on how to prepare such plans.

This report emphasizes the introduction of CSS principles early in the planning process. Network and corridor planning is an early opportunity to integrate community goals into specific urban thoroughfare projects. This helps expedite the project development process by identifying and addressing key issues and community objectives early, rather than for the first time during the planning and design of an individual thoroughfare project. Integrating CSS principles into the network and corridor planning process can:

- Determine how decisions for individual thoroughfare segments affect the corridor and network as a whole;
- Establish objectives, operational concepts, performance measures and thresholds, land uses, access control and functional classification for an entire network or corridor, which can be applied to individual thoroughfare segments in project development; and

The Roles of Network and Corridor Plans

Long Range or Regional Network Plan:

- Links transportation system to other metropolitan functions such as land use, environment, economy and so forth;
- Defines the transportation system for large areas in terms of corridors and guidance for the finer-grained network between corridors;
- Integrates multimodal systems such as highways, streets, freight, transit, bicycle and pedestrian; and
- Develops modal networks such as a thoroughfare plan, rail system, bus system, or bicycle network.

Corridor Plan:

- Links corridor to surrounding metropolitan functions such as land use;
- Coordinates and integrates multiple modes of transportation within the corridor; and
- Establishes the function and operation and design criteria for the individual facilities in the corridor.

Project Development Process:

- Confirms need for facility improvement;
- Develops conceptual, preliminary and final designs;
- Provides analysis of potential environmental impacts and mitigation measures; and
- Establishes costs and implementation program.

- Allow for policy, political and public debate on issues that impact a broader area than an individual thoroughfare segment (e.g., regional, corridor, community).

The early integration of CSS principles will influence desired change systematically rather than a piecemeal process.

Objectives

This chapter

1. Provides CSS principles and considerations for planning and designing transportation networks and corridors;
2. Provides guidelines on how CSS principles can be applied and design issues addressed at the network or corridor planning level;
3. Emphasizes that solutions may be found at the scale of the network and corridor rather than the individual thoroughfare (such as a denser network of streets or parallel facilities that provide equivalent function and capacity to the alternative of widening an individual thoroughfare); and
4. Shows how thoroughfares function within a network and how the CSS approach to improvements of specific segments of a thoroughfare relate to the thoroughfare's role in the network.

The guidelines presented in this chapter apply to both new development and retrofit conditions. Improving an existing situation will depend on the degree of connectivity, flexibility and capacity of the existing network, and the extent the network can be modified to accommodate the desired improvements.

Introduction

Chapter 2 presented a broad overview of the transportation planning and project development processes and described how CSS principles can be applied in each step of the process. This chapter builds on Chapter 2 by describing principles and guidelines that can be used at the network and corridor scales to create or improve urban walkable areas.

Network, or “system,” planning sets the strategic direction and framework around which the various components and facilities will eventually be constructed or redeveloped. It is a series of high-level incremental plans leading to the design of individual thoroughfare segments that is consistent with the framework. Network planning defines goals for all modes of transportation and facilities. These long-range plans typically contain:

- A vision for the ultimate transportation system, goals and policies related to each mode of travel;
- Technical information on travel patterns and forecasts;
- A capital program for individual projects as part of the transportation system; and
- An action plan for implementing the plan over time.

The long-range transportation plan should consider the role and function of a multimodal transportation network for an entire region or metropolitan area. Corridors are transportation pathways that provide for the movement of people and goods between and within activity centers. A corridor plan encompasses single or multiple transportation routes or facilities (such as thoroughfares, public transit, railroads, highways, bikeways, trails, or sidewalks), the adjacent land uses and the connecting network of streets.

Corridor planning encompasses a scale that is large enough to consider the context and network, but small enough to be comprehensible by the public. Corridor planning applies multiple strategies to achieve specific land use and transportation objectives along a transportation corridor, combining capital improvements and management strategies into a unified plan for the corridor.¹

CSS in Network Planning

Oftentimes the challenges encountered creating more walkable urban thoroughfares can be resolved at the scale of the network or the corridor. Network planning:

- Establishes a framework for the transportation system;

¹ Corridor planning as defined by the New York State Department of Transportation.

- Distinguishes for individual segments;
 - Functions;
 - Modal emphasis; and
 - Operational features.

Familiar characteristics addressed include:

- Alignment;
- Spacing;
- Functional classification;
- Access control;
- Determination of number of lanes; and
- Designation for major freight and transit routes.

Ideally, network planning takes place at the early stages of regional development and is integrated into a comprehensive planning process that concurrently addresses land use, transportation and environmental resource management. In practice, especially in areas with multiple jurisdictions, network planning is often conducted in a piecemeal manner by multiple agencies with different geographic jurisdictions, missions and powers. For the practitioner planning or designing a thoroughfare segment, considering network design and function can lead to solutions that balance between demands for vehicle throughput and support for adjacent development.

The design process—the subject of this report—needs to recognize the role of a thoroughfare as part of a large-scale, multimodal network. The project development process should consider the regional, subregional and neighborhood functions of the thoroughfare in relation to urban form and character. The design of the individual thoroughfare, therefore, is linked to both its context and the performance of the network. A multimodal network may identify some thoroughfares that emphasize vehicles or trucks, while others emphasize pedestrians and transit.

CSS merges a community’s comprehensive corridor objectives with mobility objectives in a manner acceptable to a variety of stakeholders. Two critical common characteristics for desirable thoroughfares are compatibility and support for the corridor context and providing a high degree of multimodal connectivity.

The context may vary along the length of the thoroughfare. The combination of function, context, or other changes may cause the design of the thoroughfare to vary along its length.

Network characteristics have a meaningful impact on urban development patterns. For example, compact, mixed-use areas are dependent on a pattern of highly connected local and major thoroughfares. The high level of connectivity results in short blocks that provide many choices of routes to destinations, support a fine-grained urban lot pattern and provide direct access to many properties. Walkable suburban areas should be similarly supported by a high level of street or path connectivity.

One fundamental tension that is commonly encountered in the application of CSS principles is between the desire of local residents to emphasize character and walkability in thoroughfare design and the desire of transportation agencies to emphasize vehicle capacity or the ability to accommodate projected regional travel demand. The tension between these objectives is best addressed through consideration of the broader network and corridor in conjunction with the individual thoroughfare.

Network characteristics are factors that provide opportunity for CSS. Connectivity, parallel routes and corridor capacity contribute to a transportation system that can accommodate projected demand by dispersing traffic, transit, freight and bicyclists across a system of parallel roadways.

This report addresses urban thoroughfares except limited-access facilities and local streets. However, when considering network design, properly located express thoroughfares—freeways/tollways, expressways and parkways—supplement the urban arterial thoroughfare network by providing high-speed, high-capacity service for longer trips. High vehicular capacity facilities permit other thoroughfares to balance the movement of traffic with other local objectives. If well connected to the larger thoroughfare network, local streets can also provide parallel capacity in the network to accommodate local, shorter trips.



Figure 3.1 Example of a conventional network.
Source: Data available from U.S. Geological Survey, EROS Data Center, Sioux Falls, SD.



Figure 3.2 Example of a traditional network.
Source: Data available from U.S. Geological Survey, EROS Data Center, Sioux Falls, SD.

Effective Network Planning for Walkable Areas

Network planning at the regional scale by regional or metropolitan planning agencies typically includes only highways, arterials and major collector systems. The planning of the finer grid of local residential and commercial streets is typically prepared at the county and/or city scale. As described above, regional network planning establishes the framework for the planning of county- and citywide networks. County- and citywide transportation plans establish a framework for planning and designing the local street system and individual thoroughfares. Finally, site planning and the project development process achieve the highest level of detail. The network types discussed below encompass both regional and local scales, since later discussions on thoroughfare design are influenced by the pattern of fine-grain networks.

Network Types

Most urban areas have a system of arterial streets, some of which may be highways. The most efficient systems have arterials with extended continuity, usually traversing all or much of an urban area except where barriers exist. The most efficient urban networks—which provide enough parallel streets to provide route flexibility and an opportunity for special street functions—have arterials spaced at half a mile or less. The important features of the arterial systems are connectivity and continuity.

Within the arterial street framework is a finer network of thoroughfares. These finer networks are sometimes characterized as either “traditional” or “conventional.”

The typical conventional street network is often characterized by a framework of widely spaced arterial roads with connectivity limited by a system of large blocks, curving streets and a branching hierarchical pattern often terminating in cul-de-sacs (**Figure 3.1**). In contrast, traditional networks (**Figure 3.2**) are typically characterized by a less hierarchical pattern of short blocks and straight streets with a high density of intersections.

The prototypical traditional and conventional networks differ in three easily measurable respects: (1) block size, (2) degree of connectivity and route choice and (3) degree of curvature. While the last measure does not significantly affect network performance, differences in block size and connectivity create very different characteristics.

Comparative Advantages

Both network design types have advantages. Advantages of traditional grids include

- Dispersing traffic rather than concentrating it onto a limited number of thoroughfares, thereby reducing the impacts of high traffic volumes on residential collectors;
- More direct routes, which generate fewer vehicle miles of travel (VMT) than conventional suburban networks;

- Reducing travel delay by allowing travelers to choose alternate routes to destinations for convenience, variety, or to avoid construction or other blockages and to increase reliability of the network;
- Facilitating circulation within an area by all travel modes;
- Encouraging walking and biking with direct routing and options to travel along high- or low-volume streets and development patterns that can offer a variety of complementary destinations within close proximity;
- More transit-friendly systems, which offer users relatively direct walking routes to transit stops;
- A smaller block structure where land use can evolve and adapt over time, providing development flexibility;
- A redundancy of the network, which benefits emergency service providers, offering multiple ways to access an emergency site;
- Regularly spaced traffic signals that can be synchronized to provide a consistent speed and more frequent pedestrian crossings; and
- Opportunities for special thoroughfare uses and designs.

In contrast, conventional networks have some advantages over traditional urban grids. Advantages of conventional networks include:

- Concentration of traffic on a few routes—beneficial for auto-centric business needs;
- Reduction of through traffic within neighborhoods that results in lower traffic volumes on local streets (although traffic is higher on streets outside neighborhoods);
- Some very low-volume cul-de-sacs, which may be desirable to many residents;
- Perception of increased neighborhood security and more flexibility to accommodate large developments; and
- Increased adaptability to areas with severe topographic constraints or other barriers.

Both traditional grid and conventional networks have livability impacts that may be considered a benefit

or detriment, depending on the context and one's perspective. The impact of traditional grids results from the dispersion of traffic, resulting in some local residential streets experiencing higher traffic volumes than a similar street in a conventional network. The impact of conventional networks is the concentration of traffic, congestion and associated impacts into fewer residential arterials and collectors.

Urban Form and Transportation Networks

Transportation and land use interact with each other. Such relationships can vary by land use type, whether on a regional, community, or localized scale. This section describes this relationship.

Metropolitan planning organizations (MPOs) model travel behavior using area types such as central business district, fringe and rural. The U.S. Census Bureau definitions aid in planning by defining urban areas and dividing them into urbanized areas having more than 50,000 population and urban clusters having less than 50,000 population. Rural areas make up the remainder of the land area. Urbanized areas have structured MPO planning procedures and guide the allocation of federal transportation funding. Comprehensive plans for communities also identify areas as commercial, residential, or office use.

None of these definitions sufficiently describes urban context at a level of detail that relates the context to the transportation system or to thoroughfare design. Designers need to know the intensity of urban development and the desired travel modes that best serve its users. Context intensity gradations—called context zones—distinguish the urban built environment adjacent to and surrounding thoroughfares.

Context zones describe the physical form and character of a place. This includes the mass or intensity of development within a neighborhood or along a thoroughfare. Context zones are typically applied at the neighborhood or community level, but for the purposes of thoroughfare design, context zones are interpreted on a block-by-block basis to re-

spond to specific physical and activity characteristics. Chapter 4 further describes context zones and describes how they are used in designing walkable urban thoroughfares. In planning, understanding the context zones sets the scale for design of the regional transportation network as well as individual transportation facilities.

Planning Urban Transportation Networks

Urban thoroughfare design should be based on a combination of local needs and the role of the thoroughfare in the area or region's transportation network. The thoroughfare network should be planned to support the needs generated by the planned land uses (including intensity) while at the same time being compatible with the characteristics of the resulting neighborhoods and community—areas that may have widely varying needs, features and activity levels. The community may also have a variety of goals associated with specific neighborhoods, areas, or corridors that the thoroughfares (individual and as a network) should support.

The thoroughfare network develops from its existing state and expands in accordance with a community's comprehensive plan (or transportation plan). The density (spacing) of the network, the capacity (lanes, walkway, bicycle, transit), the space for furnishings and other components of the right of way should encourage and support the development pattern, land use type and level of development intensity in accordance with the plan. The total transportation network should function as a system of thoroughfares consisting of vehicular, pedestrian, bicycle and transit facilities that together meet and support the needs of the communities' desired urban form and growth.

Figure 3.3 shows a simplified example of a network of thoroughfares, along with context zones. For illustrative purposes, the network contains a principal street that passes through several different context zones, typical of many major thoroughfares. Also shown are boulevards, avenues and streets in a highly connected network that ultimately connects to the regional highway system. Network capacity, in

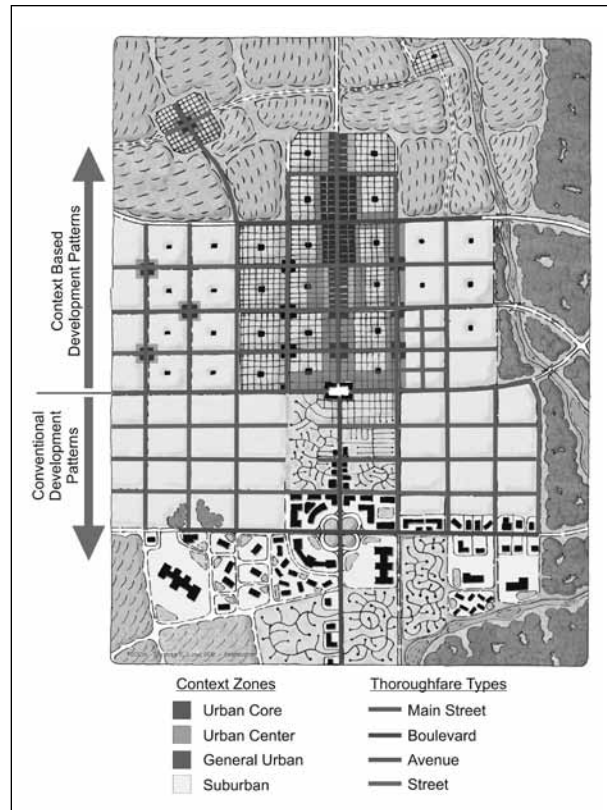

Figure 3.3 Context based development patterns are formed around a highly connected network of walkable thoroughfares. Source: Thomas Low (DPZ) and Digital Media Productions.

the form of a dense system of thoroughfares (not necessarily more travel lanes on individual facilities), needs to be greatest in the high-intensity areas.

The level of capacity in these high-intensity areas will depend on the degree of interaction among local land uses, the amount of multimodal activity generated and the amount of through travel using the network. As further described in Chapter 4, the design of the individual thoroughfare needs to respond, adjust and support the different development and activities associated with changes in context zone.

Network Planning Principles for Walkable Urban Thoroughfares

The following principles describe an approach for planning and designing urban thoroughfare networks that are sensitive to community objectives and context and will help create a more walkable environ-

ment on appropriate facilities in the network. These principles should be considered together to create effective networks.

Planning Multimodal Networks

- Multimodal network planning should be integrated into long-range comprehensive plans that address land use, transportation and urban form.
- Network planning should address mobility and access needs associated with passenger travel, goods movement, utilities placement and emergency services.
- Reserving right of way for the ultimate width of thoroughfares should be based on long-term needs defined by objectives for both community character and mobility.

Indices For Network Connectivity and Accessibility

- **Links and nodes** (index): Roadway (or modal) links divided by the number of nodes (intersections). Ranges from 1.00 (poorest level; all cul-de-sacs) to 2.50 (full grid). Minimum index defining a walkable community is 1.4 to 1.6.
- **Intersection ratio:** The ratio of intersections divided by intersections and dead ends, expressed on a scale from zero to 1.0 (US EPA, 2002). An index of more than 0.75 is desirable.
- **Average intersection spacing:** For walkability, a maximum distance of 660 feet; desirable spacing is less than 400 feet.
- **Intersection density:** The number of surface street intersections within a given area, such as a square mile. The more intersections, the greater the degree of connectivity.
- **Blocks per square mile:** For walkability this index should be at least 100.
- **Directness (index):** Actual travel distance divided by direct travel distance. Ideal index is 1.0. For walkability, index should be 1.5 or less.

Sources: Texas Transportation Institute, Adapted from: Donohue, Nick, "Secondary Street Acceptance Requirements," Office of the Secretary of Transportation, Commonwealth of Virginia. Spring 2008. "Smart Growth Index Model," U.S. EPA 2002.

Network planning should be refined and updated to define alignments and to establish the role of thoroughfares as more detailed planning and development occur.

Street Connectivity and Spacing

- Networks should provide a high level of connectivity so that drivers, pedestrians and transit users can choose the most direct routes and access urban properties. Connectivity should support the desired development patterns. Networks should provide intermodal connectivity to easily transfer between modes.
- Intersperse arterial thoroughfares with a system of intermediate collector thoroughfares serving local trips connecting neighborhood and subregional destinations.
- Expand the typical definition of collectors to recognize their role in connecting local origins and destinations in order to distribute trips efficiently, keep short local trips off the arterial system and provide a choice of routes for transit, pedestrians, drivers and bicyclists (**Figure 3.4**).
- Build network capacity and redundancy through a dense, connected network rather than through an emphasis on high levels of vehicle capacity on individual arterial facilities. This approach (more thoroughfares rather than wider thoroughfare facilities) ensures that the network and thoroughfare facilities can support other objectives such as pedestrian activity, multimodal safety and support for adjacent development.
- Highly connected networks may reduce or eliminate the need for additional capacity that results from poorly connected thoroughfares by providing highly connected networks.
- Minimize property access directly onto arterials through design of a connected network of closely spaced arterial and collector thoroughfares and local street connections. With fewer driveway-type interruptions, arterial thoroughfares can perform more efficiently for both vehicles and for pedestrians. Thus, network connectivity can provide a foundation for access management strategies to increase corridor capacity and accessibility.

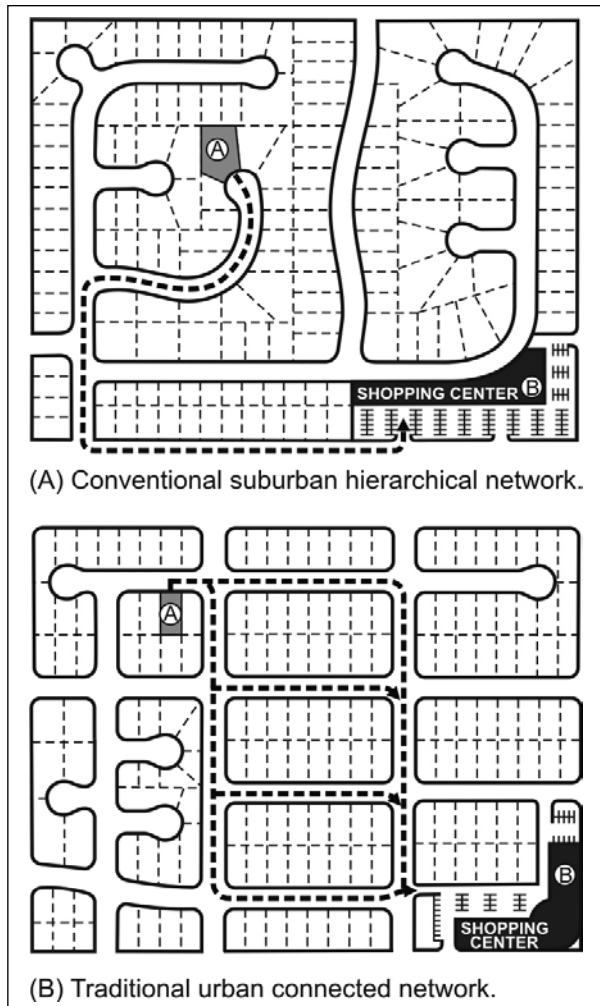

Figure 3.4 The collector in a typical hierarchical network (A) channels traffic from local streets to the arterial street system. A system of parallel connectors (B) provides multiple and direct routes between origins and destinations. Source: Kimley-Horn and Associates, Inc. and Digital Media Productions.

Performance Measures

Performance measures should be selected to describe how well the system will perform in accordance with network objectives. Such measures are often used to compare network plan alternatives or measure performance of a network according to specific objectives. The following may aid in selecting appropriate measures:

- Select transportation performance measures that reflect stakeholder objectives and priorities for the system or facility being planned or designed. Some of these may not be strictly transportation measures but include economic development and other types of measures.

- Use performance measures that recognize all modes.
- Performance goals can vary for different parts of the network as long as direct comparisons are made to the same measures.
- Performance measures could include conventional measures of vehicle congestion, capacity and density, considered at a networkwide or corridorwide level.
- To reflect walkability and compact development, consider measures such as a connectivity index, intersection density measures and pedestrian environment measures.
- Selected performance measures should include measures of safety for all users.

NCHRP Report 446, A Guide to Performance-Based Transportation Planning, provides more information on performance measurement.

Network Design Guidelines

This section provides specific considerations and guidelines for network design. The guidelines provided in this section are applicable for:

1. Greenfield development—establishing, augmenting, or reconfiguring a system of thoroughfares to serve an undeveloped or newly developing area or long-range plans for future development.
2. Reuse and redevelopment—large projects in mature urban areas that permit reconfiguration or changes in the function of adjacent or nearby thoroughfares. In these situations, changes might include the following:
 - Surrounding land uses;
 - Thoroughfare alignment or the addition of new routes or connections;
 - Emphasis in mode or usage (such as exclusive busways, wider sidewalks to serve adjacent economic activities and addition of bike lanes) or accommodating freight movement;
 - Functional classifications; and
 - Modal split allowing reallocation of (network) right of way among modes.

Ten Thoroughfare Network Planning Principles

Major thoroughfare networks should

1. Connect and provide access to and between communities, centers of activity and neighborhoods of all types, as well as recreational and cultural facilities;
2. Form a gridlike pattern of continuous thoroughfares except as precluded by topographic barriers;
3. Conform with and follow natural topographic features and avoid adverse impacts to natural resource areas;
4. Meet spacing and connectivity criteria similar to those presented in this chapter;
5. Be designed to efficiently accommodate emergency vehicles, providing multiple routes to reach any block;
6. Have thoroughfares interconnected with specified distances between intersections to provide choices of routes to reduce travel distances; to promote use of transit, bicycles and walking; and to efficiently accommodate utility needs;
7. Provide signalized crossings to encourage use of walking, bicycles and transit;
8. Be comprehensible to the average traveler;
9. Communicate the intended functions of individual thoroughfares through both design characteristics and appearance; and
10. Develop operating plans to serve all modes and all users, with uses varying on some thoroughfares according to context, needs, objectives and priorities while considering overall network needs.

3. Facility reconstruction—reconstruction of major sections of one or more thoroughfares provides an opportunity to make network changes more compatible with existing context/land uses, such as converting from a two-way thoroughfare to a one-way couplet (or vice versa), realigning a thoroughfare to improve accessibility to surrounding properties and reallocating right

of way to better balance design elements among various modes of travel.

General Network Guidelines

- The system of multimodal thoroughfares may be organized by the context zones, functional classifications and thoroughfare types as described in Chapter 4.
- The thoroughfare network should be designed to serve transit, pedestrians and bicycles as well as private and commercial vehicles.
- Transit networks should focus on and take advantage of built or planned transit-oriented and transit-adjacent developments.
- Planning for right of way should consider needs based on multimodal network performance measures that allow capacity and level of service to be considered in conjunction with other measures, both quantitative and qualitative. The CSS process should be open to the selection of decision criteria that balance community character and capacity enhancement or congestion relief.

Street Spacing Guidelines for Walkable Areas

- The basic form of the thoroughfare system is shaped by the spacing and alignment of arterial thoroughfares. The system of arterials should be continuous and networked in a general rectilinear form. In urban areas, arterial spacing may need to be one-half mile or less. In denser urban centers and core areas, arterials may need to be spaced at one-quarter mile or less.
- In more conventional suburban areas that are intended to remain so, arterial spacing of up to one mile may suffice if facilities of up to six lanes are acceptable to the community. The arterial thoroughfares should be supplemented by thoroughfares spaced at most one-half-mile apart. Such areas typically are interspersed with areas of mixed-use and walkable activity, such as commercial districts and activity centers. These centers require more frequent and connected networks of local streets.
- Closer spacing of thoroughfares (one-quarter mile for collectors) may be needed depending on pedestrian activity levels, desired block patterns and

continuity. Natural features, preserved lands, or active agriculture may break up the pattern.

- Sketch planning demand estimation or travel forecasting models should be among the tools used to estimate the spacing and capacity needs for urban thoroughfares within the minimum spacing described above. However, for walkable areas, walkability criteria may require closer spacing.
- The network should include a system of bicycle facilities with parallel routes, with direct connections to major trip generators such as schools, retail districts and parks. Bicycle facilities may include on-street bike lanes, separated paths, or shared lanes on traffic-calmed streets with low motor vehicle volumes.

Local streets should be configured in a fine-grained, multimodal network internal to the neighborhood, with many connections to the system of thoroughfares. Where streets cannot be fully networked, they should be supplemented by pedestrian and/or bike-pedestrian facilities to provide the desired connectivity.

Pedestrian facilities should be spaced so block lengths in less dense areas (suburban or general urban) do not exceed 600 feet (preferably 200 to 400 feet) and relatively direct routes are available. In the densest urban areas (urban centers and urban cores), block length should not exceed 400 feet (preferably 200 to 300 feet) to support higher densities and pedestrian activity.

Urban Corridor Thoroughfare Planning for Walkable Urban Areas

Corridors are transportation pathways that provide for the movement of people and goods between and within activity centers. A corridor encompasses a single transportation route or multiple transportation routes or facilities (such as thoroughfares, public transit, railroads, highways, bikeways and so forth), the adjacent land uses and the connecting network of streets (**Figure 3.5**).

Corridor planning is one of the incremental steps for network planning in the long-range transportation plan to thoroughfare design in the project development stage (see **Figure 3.5**). The purpose of corridor planning is to comprehensively address future transportation needs and recommend a series of physical improvements and operational and management strategies within a corridor. Corridor planning fills the gap between long-range transportation planning and project development. It identifies and provides a link between corridor land-use planning and corridor transportation planning and provides an opportunity to direct future development within the corridor. An important benefit of corridor planning is that it addresses issues prior to reaching the project development stage for transportation improvements within the corridor. Finally, it promotes interagency cooperation and broad stakeholder and public involvement. Corridor plans should address the following: (ID DOT 1998)



Figure 3.5 Corridors include multiple transportation facilities, adjacent land uses and connecting streets. Source: Kimley-Horn and Associates, Inc.

- Long-range vision for the corridor;
- Existing conditions of the transportation system and analysis with regard to the performance objectives;
- Existing and future environmental, land-use and socioeconomic conditions in the corridor area, including a community profile, current and planned land uses, historical and cultural buildings and sites, and key environmental resources and environmental issues;
- Public and stakeholder involvement strategy;
- Purpose, need and the relative importance of corridor needs through project goals and community objectives;
- Expected future multimodal travel demand and performance of existing and programmed transportation improvements;
- Identification of feasible alternatives by evaluating all options and comparing costs, impacts, trade-offs and the degree to which the alternative meets established goals;
- Available and expected funding for transportation improvements in the corridor; and
- Long- and short-range recommendations.

The corridor planning process generally mirrors the transportation planning process in its fundamental steps of a needs study, alternatives development, alternatives evaluation and selection of a preferred alternative, which leads to either the developing a detailed plan or implementing the project development process (preliminary design).

Integrating CSS into urban corridor thoroughfare planning requires stakeholders to consider the economic, social and environmental consequences of alternatives. It defines the short- and long-term needs of the corridor, develops goals and objectives that will achieve the vision of the corridor and evaluates feasible multimodal alternatives.

The outcome of CSS in urban corridor thoroughfare planning goes beyond just street improvements. Corridor planning integrally addresses transportation improvement, land development and redevelopment, economic development, scenic and historic preservation,

community character and environmental enhancement. Because urban corridor thoroughfare planning affects a broad spectrum of the community, public and stakeholder involvement is a central element of the process. The basic steps in the planning process include:

- Corridor vision;
- Project needs;
- Alternatives development;
- Alternatives evaluation; and
- Selection of preferred alternative.

In some cases, urban corridor thoroughfare planning may be integral with environmental studies leading to a National Environmental Policy Act document (www.epa.gov/compliance/nepa) or other environmental impact assessment. **Figure 3.6** illustrates the steps in the corridor planning process and identifies the type of input needed at various stages in the process.

The basic steps in the process, and how CSS principles can be integrated, are described below:

- **Corridor Vision:** Similar to any application of CSS principles, the process begins with a vision for the corridor. A vision is a corridorwide expression of how the corridor will be viewed in the future. Goals for the corridor expand on the vision by identifying the achievements that will result from implementing the corridor's plan. Developing objectives and a vision for a corridor can occur as part of a long-range transportation plan or as part of the corridor planning process. Public and stakeholder input and involvement are critical inputs when developing a vision, because the vision needs to reflect the goals and objectives of the community and address more than the transportation function of the corridor. The corridor vision feeds directly into the project needs step.
- **Needs:** As with developing a vision, the needs for the project may be developed in a long-range transportation plan if there is one or may be developed as part of the corridor planning process. The project needs include a problem statement that reflects the needs of all users and also reflect the corridor's existing (and future) context and characteristics. Stakeholder input is necessary to identify values, issues, priorities, goals and objec-

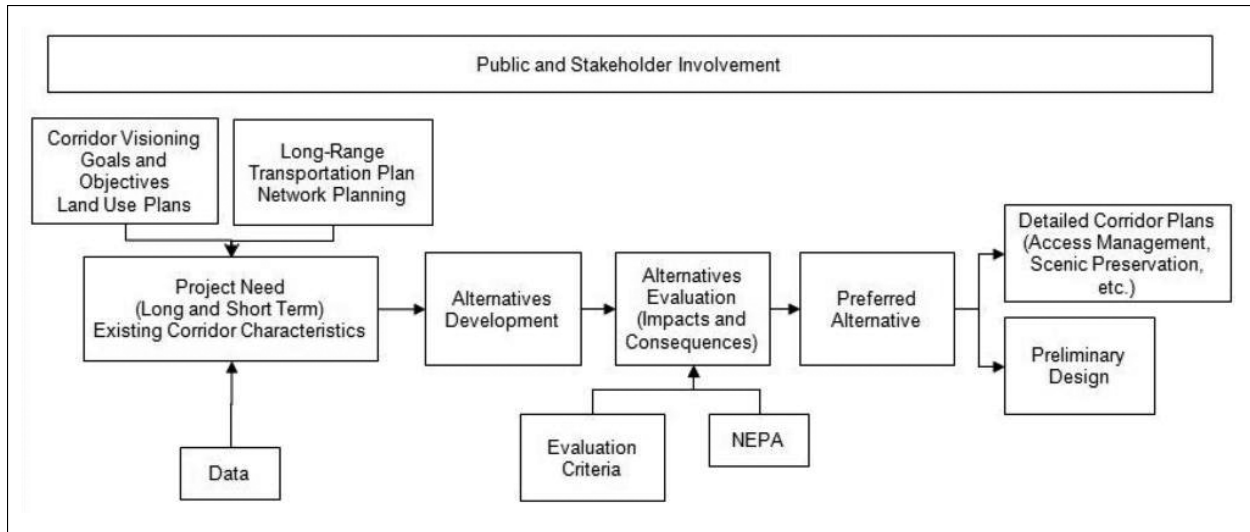

Figure 3.6 The corridor planning process. Source: Kimley-Horn and Associates, Inc.

tives. Much of this same input will help form criteria for assessing alternatives in the next phase.

- **Alternatives Development:** The corridor planning process includes a participatory public process to define and develop alternatives. The alternatives need to address the problem statement identified in the project needs step and also reflect the community vision and objectives. Stakeholder input is necessary to identify values, issues, priorities and criteria for assessing alternatives. The CSS outcome of this step is an inclusive problem statement, a short- and long-range vision for the corridor and goals and objectives that will direct the development of alternatives.

With a CSS approach, the needs may be stated in terms of context, economic, or other community aspects, as well as mobility needs. The CSS outcome of this step is to provide stakeholders and decision makers (bodies that approve the funding and implementation of projects) with a wide range of choices derived from a collaborative and participatory process. The alternatives should be competitive in that they address as many of the goals and objectives as possible. Solutions should be innovative and flexible in the application of design guidance. The solutions should include ways to enhance and meet the needs of the context, activities generated by adjacent and nearby land uses and objectives that are part of the community vision for the corridor.

Corridor Vision and Needs

CSS Approach

- Public and stakeholder input
- Corridor and context characteristics
- Identify values and issues

CSS Outcome

- Inclusive problem statement
- Corridor vision
- Goals and objectives

Alternatives Development

CSS Approach

- Interactive and participatory process
- Alternatives address problem statement and reflect objectives

CSS Outcome

- Broad range of solutions derived from collaboration
- Innovation and flexibility

To the extent not already included in the community vision, consideration should also be given to potential environmental consequences when developing the corridor alternatives. Alternatives may include different alignments and parallel routes, cross-sections, modal combinations, streetside treatments, interaction with adjacent development, streetscape approaches, business and community activity and support infrastructure. The important thing to remember is that the alternatives in CSS are developed to meet the full range of a specific community or neighborhood's objectives.

- **Alternatives Evaluation:** The goal of the alternatives evaluation is to provide an objective and balanced assessment of impacts, trade-offs and benefits of each alternative (Figure 3.7). This requires careful selection of, and stakeholder agreement on, evaluation criteria. The criteria need to reflect not just transportation objectives but the community and environmental objectives as well. Examples of evaluation criteria categories and related measures include:

justice; residential and business displacement/dislocation; socioeconomic and equity; neighborhood integrity and cohesion; economic development; place making qualities; and so forth).

Environmental Effects: positive and negative effects of natural environment (air quality, noise, energy consumption, water quality and quantity, vegetation, wildlife, soils, open space, park lands, ecologically significant areas, drainage/flooding aesthetics and visual quality); and land use (residential patterns, compatible uses, development suitability according to community values and so forth.).

Cost-Effectiveness and Affordability: capital costs, operations and maintenance costs, achievement of benefits commensurate with resource commitment, sufficiency of revenues and so forth.

Alternatives Evaluation

CSS Approach

- Public and stakeholder input
- Evaluation criteria that reflects community, environmental and transportation objectives and concerns

CSS Outcome

- Clear assessment of trade-offs
- Participatory process

Mobility for All Users: travel demand, roadway capacity, level of service, travel time, connectivity, circulation, access, truck movement, access to multiple travel modes and so forth.

Social and Economic Effects: socioeconomic and cultural environment (historic, cultural and archaeological resources; environmental

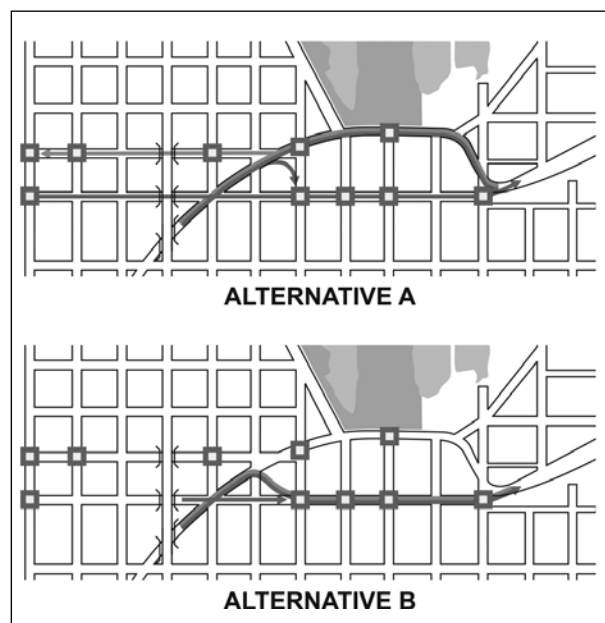

Figure 3.7 Corridor planning involves the consideration of trade-offs between alternatives. In this example of a corridor study, different alignments and reconfiguration of streets are evaluated and compared. Source: City of Seattle, CHM2Hill, South Lake Union Transportation Study, Mercer Corridor Project.

Other Factors: compatibility with local and regional plans and policies, constructability, construction effects and so forth.

The alternatives evaluation step includes a comprehensive evaluation of applicable issues and options using selected criteria such as those described above (such as modal capacity; alignment; design concept; costs; right of way; environmental, social and economic impacts; operations; safety; and so forth). Alternatives can be a combination of capital improvements and management and operations strategies. The outcome of this step is the clear communication of trade-offs to the public, stakeholders and decision makers, developed and discussed in a transparent and participatory process.

- **Selection of Preferred Alternative:** The selection of a preferred alternative is, ideally, a consensus-based process. Consensus building in this step engenders community ownership in the selected alternative and helps achieve a commitment toward implementation of the plan or project. The CSS process uses an array of tools for selecting, refining and building consensus on alternatives. A successful selection of a preferred alternative is one that is compatible with the context(s), reflects the needs of all users and best achieves the objectives and vision established for the corridor.

The selection of a preferred alternative leads to either the development of a detailed corridor plan, such as a thoroughfare plan, access management plan, scenic preservation plan, streetscape plan, or economic vitalization plan. It can also lead to the preliminary design of an individual thoroughfare, network of thoroughfares, or multimodal transportation corridor with parallel thoroughfares, rail, transit, highway and bikeway systems.

Selection of Preferred Alternatives

CSS Approach

- Participatory process, using workshops or charettes to refine concepts
- Consensus building

CSS Outcome

- Alternative fits within the context
- Composite solution for all modes and users
- Preferred alternative that balances across objectives and evaluation criteria

Corridor planning varies in level of effort ranging from large-scale planning efforts for corridors in newly developing areas to small-scale planning of segments of individual thoroughfares within constrained rights of way. The outcome of corridor planning ranges from broad policies to statewide and regional long-range transportation plans to multimodal systems plans, as well as to local thoroughfare plans and individual segment concepts and designs (**Figure 3.8**). CSS plays a role in any type of corridor planning. The remainder of this report focuses on the detailed design of thoroughfares.

CSS Example in Corridor Planning—Developing Evaluation Criteria

SR 179 Corridor Plan

The Arizona Department of Transportation (ADOT) worked with the community of the greater Sedona area in the Coconino National Forest to design and construct improvements to the 9-mile stretch of SR 179. This road carries millions of tourists each year through one of the most pristine and unique areas of the world. The road is also the only route connecting the business and residential communities of the greater Sedona area. While there have been improvements to SR 179, continuing traffic buildup will continue to exacerbate the capacity and safety issues of the road during the next 20 years.

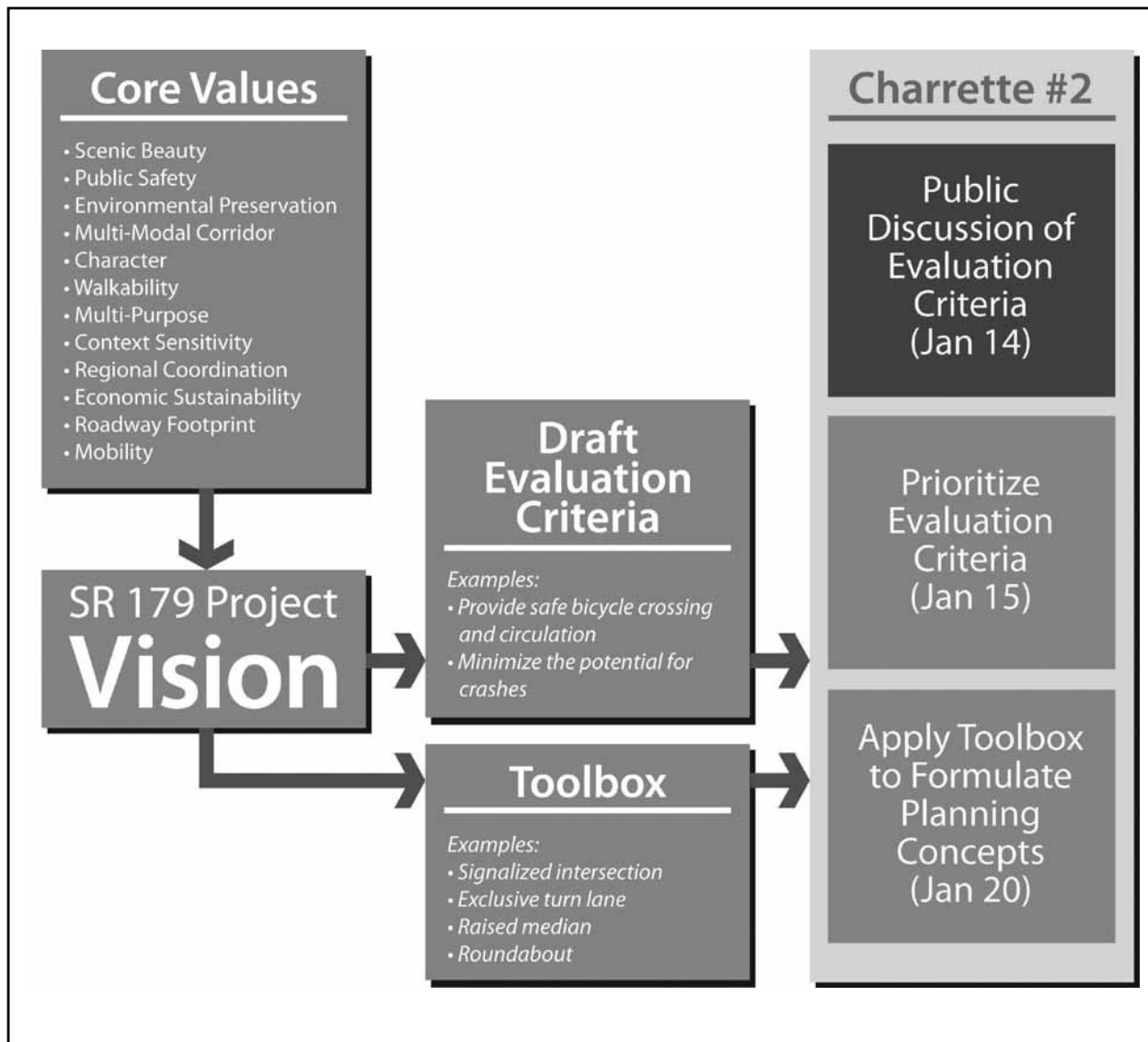

Figure 3.9 The needs-based implementation plan included a community-based process to develop criteria to evaluate corridor alternatives. Source: Arizona Department of Transportation, DMJM+Harris.

- Multimodal—provisions for modes of travel that include bicycles and transit;
 - Character—the unique look and feel of the corridor;
 - Walkability—ability of pedestrians to circulate in the corridor and reach points within the corridor;
 - Multipurpose—a corridor that serves many needs including commuting, shopping, tourism and social trips;
 - Context sensitivity—compatibility with the unique context of the SR 179 corridor;
 - Regional coordination—a process involving stakeholders throughout the region;
 - Economic sustainability—contribution to the economic vitality of the area;
 - Roadway footprint—the width and cross-section of the corridor; and
 - Mobility—ability to provide efficient and reliable transportation services.
- Using the core values as a base, the project team worked with the community to develop, prioritize and build consensus on criteria for evaluating cor-

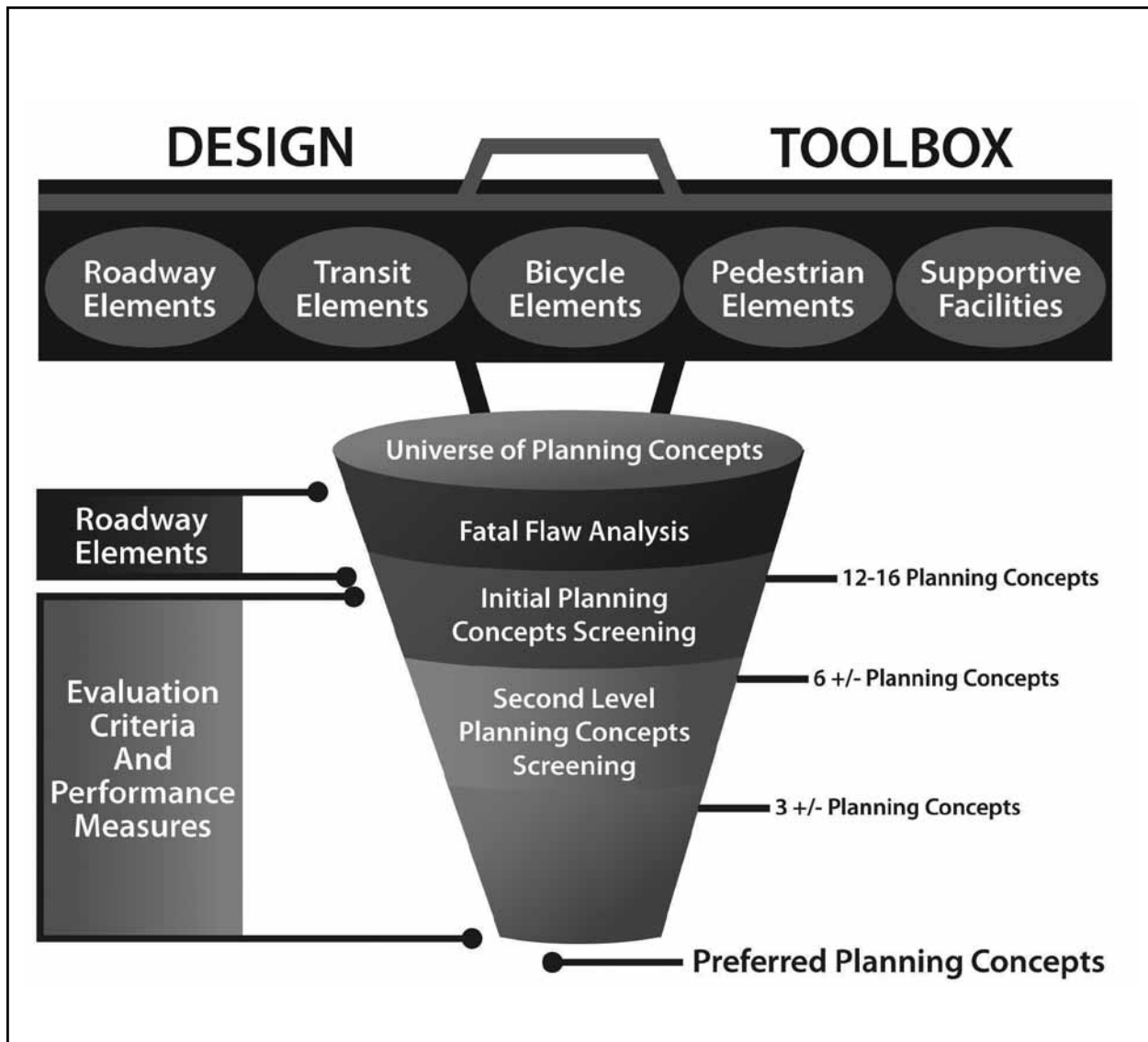

Figure 3.10 The screening process started with a wide range of alternatives and used public participation and evaluation criteria to narrow alternatives to a preferred planning concept. Source: Arizona Department of Transportation, DMJM+Harris.

ridor alternatives. The evaluation criteria and performance measures were used in a screening process to narrow the alternatives to a preferred planning concept for each segment of the corridor. **Figure 3.11** presents a sample of the evaluation criteria and associated performance measures.

An Important Note About Implementation

The benefits of a highly connected, multimodal network developed through a CSS process will not be

fully realized unless the complete network is implemented. Complete implementation requires state, county and municipal transportation agencies to preserve and protect right of way, then fund and construct (or have developers construct) the major and local thoroughfare system.

To gain network benefits early and avoid interim oversizing of roads, it is important that as development starts, the network should also be constructed in usable segments. For example, when a parcel at the intersection of two county roads is developed, the local street

Evaluation Criterion	Performance Measures
Retain and enhance the natural appearance of the landscape and the ability to enjoy scenic views from the corridor.	Number of sensitively placed scenic pullouts
	Number of new scenic vistas available
	Appropriate scenic viewing opportunity potential
Provide a distinctive corridor identity and unique experience for the user.	Opportunity for artistic and landscape amenities
	Opportunity to preserve and interpret architectural and cultural themes of the Sedona/Red Rock area
	Opportunity for design creativity to contribute to the corridor identity
Provide safe and attractive wayfinding aids (signage and informational features) for tourists and others who may be relatively unfamiliar with the corridor.	Total number of sites for wayfinding information
	Opportunities for context sensitive wayfinding signage visible from the roadway and pathways
	Opportunities to provide access to new Forest Service Ranger District Office and other connecting facilities
Provide safe vehicular and emergency access to, from and across the corridor.	Number of new safe crossings (signals or roundabouts)
	Number of locations on the mainline with left-turn storage lane or roundabout
	Number of acceleration and deceleration lanes
	Number of "right-in, right-out" ingress/egress locations
	Number of mainline entry locations
Provide safe pedestrian crossings and circulation.	Number of new safe pedestrian crossings
	Opportunities for pedestrian amenities and enhancements at intersections
	Square feet of pathways/sidewalks
	Number of trailheads directly accessible on foot from the corridor
	Number of key destinations in the corridor accessible via a connected pedestrian system

Figure 3.11 Example evaluation criteria and performance measures used in the SR 179 Corridor Plan. Source: Arizona Department of Transportation, DMJM+Harris.

network planned within the development by the MPO, county, or municipality should also be constructed.

Furthermore, at least one street should be constructed and connected through or around the initial development to ensure alternative routes are available in case of emergency, congestion, or temporary blockage.

If this approach continues as development progresses, this implementation approach will ensure that the network will evolve to completion.

Works Cited

Idaho Department of Transportation. February 1998. *Idaho Transportation Department Corridor Planning*

Handbook. Boise, ID: Idaho Department of Transportation.

Texas Department of Transportation. *IH 820 Corridor Alternatives Analysis*. Accessible via www.dot.state.tx.us/ftw/mis/ih820/project.htm.

Donohue, Nick, "Secondary Street Acceptance Requirements." 2008. Richmond, VA: Office of the Secretary of Transportation, Commonwealth of Virginia. Accessible via www.virginiadot.org/projects/resources/Spring2008SSAROutreach.pdf.

Transportation Research Board. 2000. NCHRP Report 446, *A Guidebook for Performance-Based Transportation Planning*. Accessible via http://onlinepubs.trb.org/onlinepubs/nchrp/nchrp_rpt_446.pdf.

Sources of Additional Information

Arizona Department of Transportation. SR 179 Corridor Project Web site. Accessible via www.scenic179.com/projectoverview/links.cfm. Phoenix, AZ: AZDOT

Center for Urban Transportation Research, University of South Florida. October 1996. *Managing Corridor Development—A Municipal Handbook*. Tampa, FL: USF.

Federal Highway Administration. *Corridor Traffic Management*. Accessible via ops.fhwa.dot.gov/program_areas/corridor_traffic_mgmt.htm. Washington, DC: FHWA.

Idaho Department of Transportation. 1998. *Corridor Planning Handbook*. Boise, ID: Idaho DOT.

Institute of Transportation Engineers. 1997. *Planning Urban Arterial and Freeway Systems*. Washington, DC: ITE.

Institute of Transportation Engineers. 2009. *Transportation Planning Handbook* 3rd Edition. Washington, DC: ITE.

Kentucky Transportation Cabinet. 2000. *Bluegrass Corridor Management Planning Handbook*. Frankfort, KY: Kentucky Transportation Cabinet.

Meyer, Michael D. and Eric J. Miller. *Urban Transportation Planning*, 2nd Edition. Washington, DC: ITE, 2001.

Transportation Research Board. 2003. *Access Management Manual*. Washington, DC: TRB.

Williams, Kristine M. 2001. *Implementing Multimodal Transportation Districts*. Center for Urban Transportation Research, University of South Florida. Tampa, FL: USF. Accessible via www2.cutr.usf.edu/pdf/MMTD_Regs_Draft.pdf.

Transportation Research Board. NCHRP Web Document 69, *Performance Measures for Context Sensitive Solutions*. Washington, DC: TRB. Accessible via http://onlinepubs.trb.org/onlinepubs/nchrp/nchrp_w69.pdf.

Congress for the New Urbanism. *Sustainable Transportation Networks (summary)*. Chicago, IL: CNU.



A Framework for Walkable Urban Thoroughfare Design

Purpose

This chapter describes a set of tools for use by practitioners planning and designing walkable urban thoroughfares. It describes a design framework to identify and classify context and thoroughfares and describes how the controls of context and thoroughfare type are used in the design process to establish design parameters.

The functional classification system classifies context as either rural or urban. In this report, the definition and description of the conventional urban context is expanded to provide more detailed descriptions of adjacent surroundings and to provide a way to use context as a criterion in the selection of thoroughfare type and design criteria. Context zones are used to classify urban contexts into discrete types, ranging from lower to higher density and intensity of development.

The approach described in this chapter introduces thoroughfare types as a complement to functional classification to provide a broader range of thoroughfare design choices. The use of thoroughfare types restores the former practice of distinguishing streets by their design characteristics in addition to their functional classification.

Objectives

This chapter:

1. Defines context as used in urban thoroughfare design and explains the features of urban areas that create and shape context;
2. Introduces the concept of “context zones” and provides guidance to help practitioners use this tool;
3. Describes the features that create context including land use, site design and urban form, and building design;
4. Describes the different types of thoroughfares and their relationship to functional classifications; and
5. Describes features of thoroughfare types and context zones that result in compatibility.

Introduction

The design of viable, well-functioning urban thoroughfares depends on a clear understanding of the application of CSS principles in designing thoroughfares in the urban environment. Once urban context is understood, the function of each thoroughfare can be established and the design parameters can be selected to achieve a balance between land use and transportation design. This linkage demands special tools. While it is possible to “feel” the character of an urban area, it can be hard to define and describe the specific features that collectively give shape and character to a particular urban setting, whether it is a small town, activity center, main street, or high-density regional downtown.

Not only does context influence the design of thoroughfares, but the design of the thoroughfare itself helps to define and shape the context as much as adjacent land uses and buildings define and shape context. For these reasons, this document recommends a clear focus on context first, followed by detailed transportation planning to support the context in a balanced way.

Conventional thoroughfare design processes emphasize vehicular mobility and the provision of automobile access to adjoining land uses, primarily using functional classification, traffic volume and design speed as the determinants for design parameters. The principles of CSS expand the design process to better integrate thoroughfares with their surroundings. The result in many communities is a new emphasis on urban thoroughfares with features that emphasize multimodal safety and mobility as well as support for the activities of the adjacent land uses. Walkability, a key focus of this document, is better planned with an initial, clear focus on context.

A main tenet of walkable thoroughfare design is encapsulated in the phrase “one size does not fit all,” which means the function of a thoroughfare and its design should complement the context that it serves,

and the design of the thoroughfare should change as the existing and planned context changes. This tenet challenges the conventional design process used by many state and municipal agencies, which applies a single roadway cross-section, based on functional classification, to a thoroughfare—regardless of the context. In this report, it is context and the change in context that determines the need to transition from one thoroughfare type to another and also determines the corresponding change in design parameters.

Thoroughfare planning and engineering requires evaluating capacity, connectivity and safety considerations in combination with meeting local objectives for urban character. The selection of appropriate design controls and performance measures, discussed further in Chapter 7, is a key step in developing suitable design solutions. The design scenarios presented in Chapter 6 provide illustrations of how context sensitive objectives can be evaluated under alternative designs and integrated into a preferred alternative.

Features that Create Context

Often, transportation planning and design considers context only in terms of land use (traffic generation) and two elements of site design—parking and access (driveways). The CSS design process for walkable urban thoroughfares expands this understanding of context to include the aspects of building and site design that create support for pedestrian and transit activity and that relate to the design of thoroughfares to result in integrated walkable environments.

Land Use

Land use is a common criterion for characterizing urban development and estimating vehicle trip generation, particularly in single-use, vehicle-dominated locations. The design framework in this report identifies land use as an important contributor to context and a major factor in the selection of design criteria (particularly as these relate to levels of pedestrian activity), assembly of the cross-section components and allocation of the width of the right of way.

In addition to having a fundamental impact on automobile travel demand, variations in adjacent land use affect the width and design of the streetside, the

part of the thoroughfare between the curb and edge of right of way including sidewalks. As detailed in Chapter 8, residential uses typically have less need for sidewalk space than similarly scaled mixed-use blocks with ground floor commercial retail uses, where space for window shopping, outdoor dining, newspaper racks and other street appurtenances add to the sidewalk width. Areas that disperse land uses into single-use areas and that rely on hierarchical circulation networks generally result in longer trips, less walking and bicycling and more dependence on motor vehicles. Commercial uses generate higher volumes of pedestrian travel and business activities that use the street-side compared to similarly scaled residential uses. With respect to the traveled way, the part of the thoroughfare between curbs, variations between residential and commercial areas include parking- and travel-lane width. Commercial areas typically have a higher volume of large vehicles such as delivery trucks and buses and have a higher turnover of on-street parking than residential areas. Thus, a predominantly commercial thoroughfare often requires a wider traveled way when compared to a predominantly residential thoroughfare in the same context zone. Commercial areas usually generate more traffic than residential areas, which affects decisions related to the number of lanes, access control and intersection design.

Site Design and Urban Form

The ways in which buildings, circulation, parking and landscape are arranged on a site has an effect on where a thoroughfare and its context fall in the continuum of walkability (see sidebar on the Continuum of Walkability in Chapter 1). The specific elements of site design that contribute to defining urban context include:

- **Building orientation and setback:** In places that have less priority for walking, buildings typically will be less related to the street either by large setbacks into private property or oriented toward a parking lot rather than the street. By contrast, a context with traditional urban character will have buildings oriented toward and often adjacent to the thoroughfare and therefore a higher priority for pedestrian travel. The directness of the pedestrian connection to the building entry from the thoroughfare—and whether the building itself is integrated into the thoroughfare’s streetside with stoops, arcades,

cafes, and so forth—distinguishes a context with traditional urban character. In these locations, buildings may form a continuous built edge or street wall (a row of buildings that have no side yards and consistent setback at the thoroughfare edge).

- **Parking type and orientation:** Parking provided in surface lots between buildings and streets defines a vehicle-dominated context with a lower priority for walking. On-street parking, and parking under or behind buildings and accessed by alleys is an urban characteristic. Thoroughfares in these areas should have a higher priority for walking.
- **Block length:** Development patterns with traditional urban characteristics usually have short block lengths with a system of highly connected thoroughfares, local streets and alleys. Vehicle-dominated contexts have larger blocks, less complete street connectivity and usually no alleys; this pattern makes walking distances longer and, therefore, it is likely that fewer people will walk between destinations. Generally, the desirable block length is 200 to 400 feet and should not exceed 600 feet. See Chapter 3 for more on block spacing.

Building Design

The design of buildings is a significant contributor to context and the priority that the context gives to walking. Building height, density and floor-area ratio, architectural elements, mass and scale, relationship to adjacent buildings and thoroughfares, orientation of the entry, and the design and type of ground floor land uses can help shape context and create an environment that is more or less walkable.

Development in contexts that give a lower priority to walking generally are more internally oriented as evidenced by how the buildings sit on their sites (as discussed above) and how the ground floor uses lack supportive relationships with adjacent streetsides and sidewalks. The lack of walkability in these contexts is not correlated with building intensity but with features of building and site design.

Buildings in locations with a traditional urban character that contributes to a walkable community are typ-



Figure 4.1 Pedestrian-scaled architectural elements.
Source: Community, Design + Architecture.

ically oriented toward the street. Ground floor uses in urban buildings are usually oriented to the pedestrian passing on the adjacent sidewalk (for example, retail, restaurant, services) and incorporate architectural elements that are interesting, attractive and scaled to the pedestrian (**Figure 4.1**). Some aspects of how building design helps define urban context include:

- **Building height and thoroughfare enclosure:** Buildings are the primary feature of urban contexts that create a sense of definition and enclosure on a thoroughfare—an important urban design element that helps create the experience of being in a city and in a place that is comfortable for pedestrians. The threshold when pedestrians first perceive enclosure is a 1:4 ratio of building height to thoroughfare width—typical of low-density environments. In denser urban contexts, height-to-width ratios between 1:3 and 1:2 create an appropriate enclosure on a thoroughfare (**Figure 4.2**). Highly walkable thoroughfares do not require tall buildings. Street trees may be used to provide a similar sense of definition and enclosure in contexts with lower height and less dense buildings.

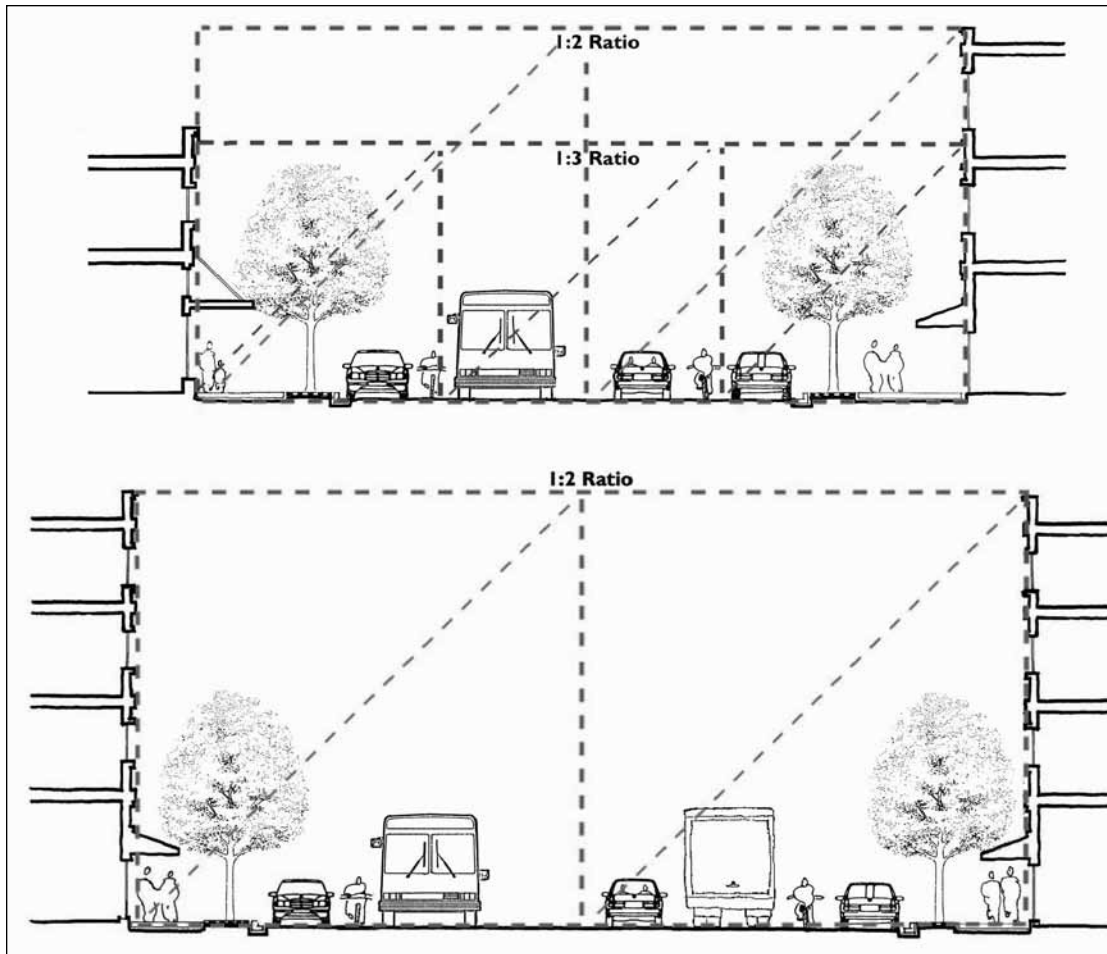

Figure 4.2 Illustration of height to width ratios that create a scale on thoroughfares that is comfortable to people and encourages walking (human scale). Human scale ratios fall between 1:3 and 1:2 as measured from the building fronts. Source: Community, Design + Architecture.

- Building width:** Building width, like building height, contributes to the sense of enclosure of the thoroughfare. There are three elements of width: (1) the percentage of a building's width fronting the street, which should range from about 70 percent in suburban environments to nearly 100 percent in urban environments; (2) the distance between buildings or building separation, which should range from 0 to 30 feet; and (3) the articulation of buildings (an architectural term that refers to dividing building facades into distinct parts to reduce the appearance of the building's mass adjacent to the sidewalk, identify building entrances and minimize uninviting blank walls) resulting in a scale of building that is comfortable to a person walking adjacent to it and adding architectural diversity and interest (**Figure 4.3**).
- Building scale and variety:** This helps define the context and character of a thoroughfare and encourages walking by providing visual interest to the thoroughfare. The scale and variety of buildings should help define the scale of the pedestrian environment. Vehicle-oriented building scale maximizes physical and visual accessibility by drivers and auto passengers, contributing to contexts that discourage walking.
- Building entries:** Building entries are important in making buildings accessible and interesting for pedestrians. To maintain or create traditional urban character, buildings should have frequent entries directly from adjacent



Figure 4.3 The frequency of articulation of a building facade contributes to a scale that is comfortable to pedestrians. Source: Community, Design + Architecture.

thoroughfares to improve connectivity and to break down the scale of the building. Frequent entries from parking lots and secondary thoroughfares should be provided as well.

More information on how building design promotes context sensitivity and sustainability can be found in *Promoting Sustainable Transportation through Site Design*, an ITE recommended practice and in the *Smart-Code* (see References for Further Reading at the end of this chapter). All elements of building design provide strong cues for the selection of a thoroughfare design.

Context Zones

Context zones describe the physical form and character of a place. This includes the mass or intensity of development within a neighborhood or along a thoroughfare. Context zones are applied at the community unit level, but for the purposes of thoroughfare design must be interpreted on a block-by-block basis to respond to specific physical and activity characteristics. **Figure 4.4** contains the descriptions of the six context zones. Zones C-3 through C-6 are urban zones that relate to urban thoroughfare design.

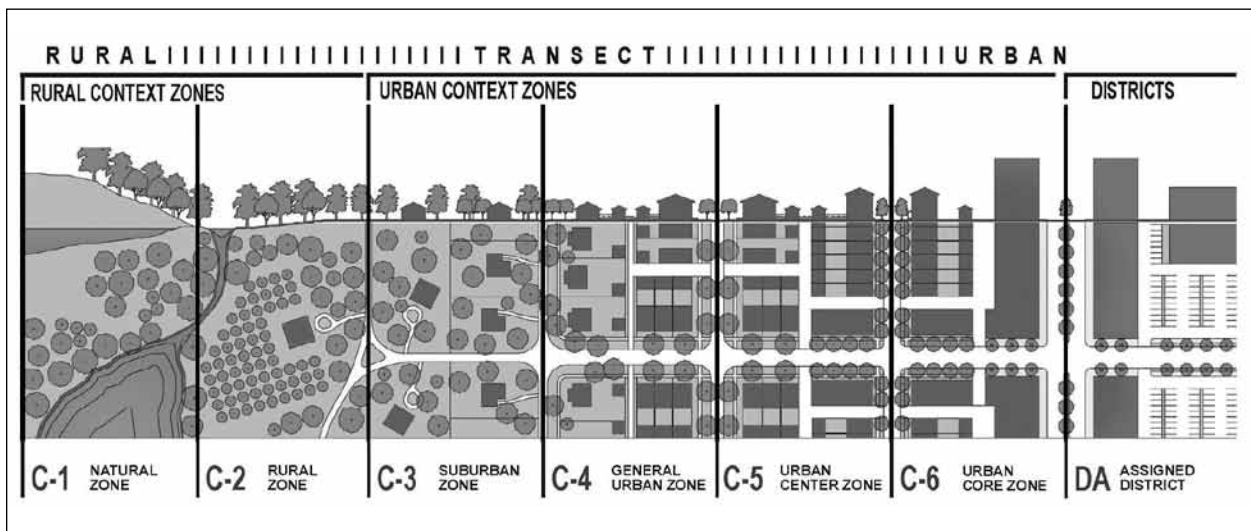

Figure 4.4 Illustration of a gradient of development patterns ranging from rural in Context Zone 1 (C-1), to the most urban in C-6. Source: Duany Plater-Zyberk and Company.

Selecting a Context Zone in Thoroughfare Design

The design process presented in this report uses context zones as a primary consideration in selecting the design parameters of urban thoroughfares. This is a refinement to the “rural” and “urban” classifications that are critical in selecting design criteria in *A Policy on the Geometric Design of Highways and Streets* (AASHTO 2004). Context zones are an important determinant of basic design criteria in traditional urban thoroughfares. This chapter helps the practitioner identify and select context zones as one of the first steps in the design process.

As **Table 4.1** shows, context is defined by multiple parameters, including land use, density and design features. **Table 4.1** presents the full range of context zones, but this report focuses on urban contexts (C-3 through C-6). The “distinguishing characteristics” column in the table, for example, describes the overall relationship between buildings and landscape that contributes to context. In addition to the distinguishing characteristics and general character, four attributes assist the practitioner in identifying a context zone: (1) building placement—how buildings are oriented and set back in relation to the thoroughfare; (2) frontage type—what part of the site or building fronts onto the thoroughfare; (3) typical building height; and (4) type of public open space.

Guidelines for identifying and selecting a context zone include the following:

1. Consider both the existing conditions and the plans for the future, recognizing that thoroughfares often last longer than adjacent buildings.
2. Assess area plans and review general, comprehensive and specific plans, zoning codes and community goals and objectives. These often provide detailed guidance on the vision for the area.
3. Compare the area’s predominant land use patterns, building types and land uses to the characteristics presented in **Table 4.1**.
4. Pay particular attention to residential densities and building type, commercial floor-area ratios and building heights.

5. Consider dividing the area into two or more context zones if an area or corridor has a diversity of characteristics that could fall under multiple context zones.
6. Identify current levels of pedestrian and transit activity or estimate future levels based on the type, mix and proximity of land uses. This is a strong indicator of urban context.
7. Consider the area’s existing and future characteristics beyond the thoroughfare design, possibly extending consideration to include entire neighborhoods or districts.

Thoroughfare Types

The design process in this report refers to both functional classification and thoroughfare type to classify streets.

The purpose of each classification as used in CSS applications for areas with traditional urban characteristics is described below.

- Functional classification—defines a thoroughfare’s function and role in the network, in addition to governing the selection of certain design controls. The practitioner may use functional class to determine:
 - Continuity of the thoroughfare through a region and the types of places it connects (such as major activity centers);
 - Purpose and lengths of trips accommodated by the thoroughfare;
 - Level of land access and level of access management;
 - Type of freight service; and
 - Types of public transit services (for example, bus, bus rapid transit, fixed guideway and so forth).

These factors are used to inform the practitioner’s decisions related to both the physical design and operations of the thoroughfare.

Table 4.1 Context Zone Characteristics

Context Zone	Distinguishing Characteristics	General Character	Building Placement	Frontage Types	Typical Building Height	Type of Public Open Space	Transit (Where Provided)
C-1 Natural	Natural landscape	Natural features	Not applicable	Not applicable	Not applicable	Natural open space	None
C-2 Rural	Agricultural with scattered development	Agricultural activity and natural features	Large setbacks	Not applicable	Not applicable	Agricultural and natural	Rural
C-3 Suburban	Primarily single family residential with walkable development pattern and pedestrian facilities, dominant landscape character. Includes scattered commercial uses that support the residential uses, and connected in walkable fashion.	Detached buildings with landscaped yards, normally adjacent to C-4 zone. Commercial uses may consist of neighborhood or community shopping centers, service or office uses with side or rear parking.	Varying front and side yard setbacks	Residential uses include lawns, porches, fences and naturalistic tree planting. Commercial uses front onto thoroughfare.	1 to 2 story with some 3 story	Parks, greenbelts	Local, express bus
C-4 General Urban	Mix of housing types including attached units, with a range of commercial and civic activity at the neighborhood and community scale	Predominantly detached buildings, balance between landscape and buildings, presence of pedestrians	Shallow to medium front and side yard setback	Porches, fences	2 to 3 story with some variation and few taller workplace buildings	Parks, greenbelts	Local, limited stop bus rapid transit, express bus; fixed guideway
C-5 Urban Center	Attached housing types such as townhouses and apartments mixed with retail, workplace and civic activities at the community or sub-regional scale.	Predominantly attached buildings, landscaping within the public right of way, substantial pedestrian activity	Small or no setbacks, buildings oriented to street with placement and character defining a street wall	Stoops, dooryards, storefronts and arcaded walkways	3 to 5 story with some variation	Parks, plazas and squares, boulevard median landscaping	Local bus; limited stop rapid transit or bus rapid transit; fixed-guideway transit
C-6 Urban Core	Highest-intensity areas in sub-region or region, with high-density residential and workplace uses, entertainment, civic and cultural uses	Attached buildings forming sense of enclosure and continuous street wall landscaping within the public right of way, highest pedestrian and transit activity	Small or no setbacks, building oriented to street, placed at front property line	Stoops, dooryards, forecourts, storefronts and arcaded walkways	4+ story with a few shorter buildings	Parks, plazas and squares, boulevard median landscaping	Local bus; limited stop rapid transit or bus rapid transit; fixed-guideway transit
Districts	To be designated and described locally, districts are areas that are single-use or multi-use with low-density development pattern and vehicle mobility priority thoroughfares. These may be large facilities such as airports, business parks and industrial areas.						As applicable

(Based on transect zone descriptions in *SmartCode* Version 9.2, 2008. Source: Duany Plater-Zyberk & Company.)

Shaded cells represent Context Zones that are not addressed in this report.



Figure 4.5 Illustration of a boulevard. Source: Claire Vlach, Bottomley Design & Planning.

- Thoroughfare type—governs the selection of the thoroughfare’s design criteria and, along with the surrounding context, is used to determine the physical configuration of the thoroughfare. Design criteria and physical configuration address which elements are included in the design and selection of dimensions. Use thoroughfare types, along with context zones, to develop designs for:

- Streetside (sidewalks, planting strips);
- Traveled way (lanes, medians, on-street parking, bicycle lanes); and
- Intersections.

Additionally, use thoroughfare type to determine the following design controls:

- Target speed (see Chapter 7); and
- Sight distance.

Table 4.2 shows specific thoroughfare types that are commonly used in the United States and gives a general description of each type. As this report focuses on urban thoroughfares in walkable areas, only three of the types in **Table 4.2** fall into this category: boule-

wards, avenues and streets. These thoroughfare types typically serve a mix of modes, including pedestrian, bicycle users, private motor vehicles (for passenger and freight) and transit.

Boulevards are typically larger thoroughfares with medians (**Figure 4.5**). They serve a mix of regional and local traffic and carry the most important transit routes. The multiway boulevard is a variant of a boulevard that contains separated roadways for through and local access traffic. Multiway boulevards may be considered when balancing the needs of abutting land uses (for example, curb parking, pedestrian facilities, land access, fronting buildings) with arterial functions. See Chapter 6 for more discussion of multiway boulevards.

Avenues (**Figure 4.6**) and streets (**Figure 4.7**) are similar to each other in form but avenues can be up to four lanes with a median. Streets are generally two lanes and serve predominantly local traffic. In walkable areas, all thoroughfare types have a strong pedestrian orientation.

Table 4.3 shows the relationship between thoroughfare types and functional classification. In general,

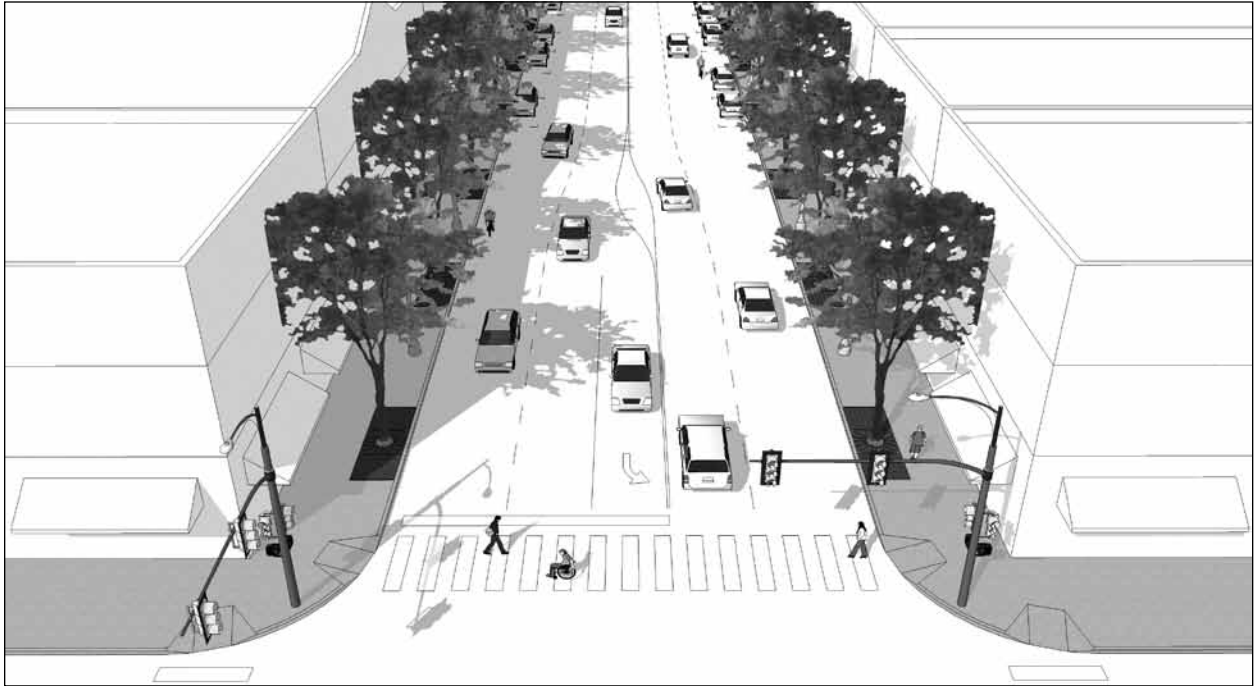

Figure 4.6 Illustration of an avenue. In this example on-street parking is dropped to gain width for a left turn lane at the intersection. Source: Claire Vlach, Bottomley Design & Planning.

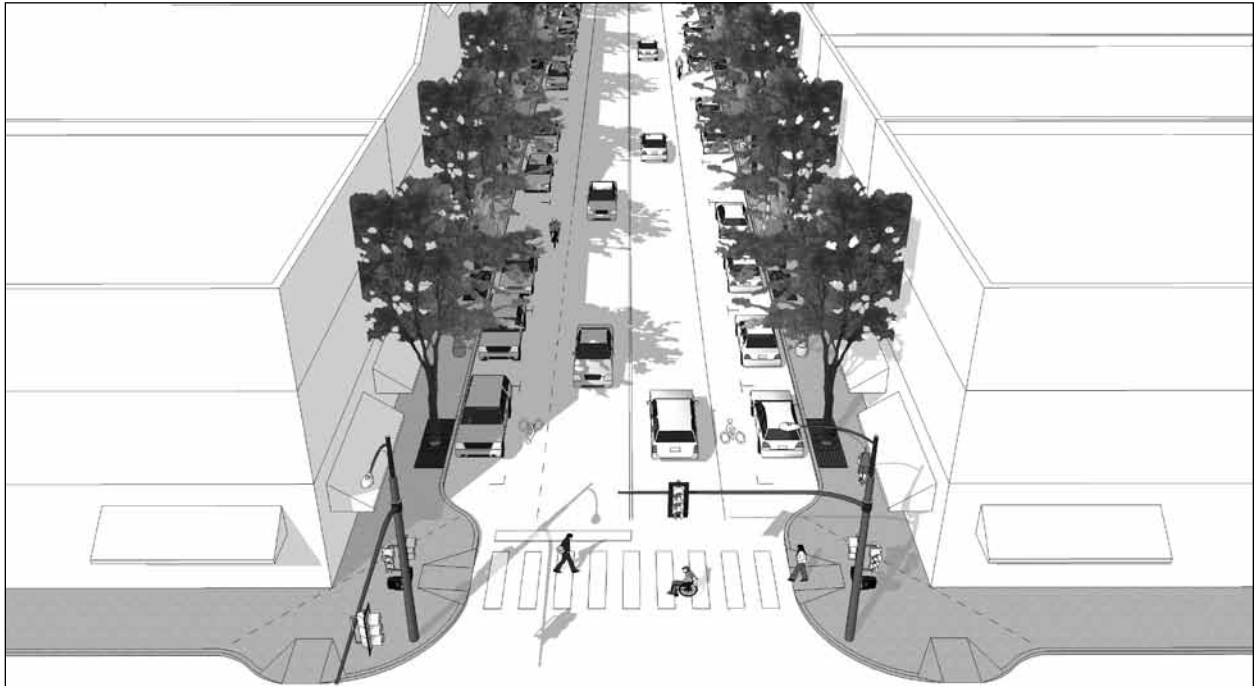

Figure 4.7 Illustration of a street. Source: Claire Vlach, Bottomley Design & Planning.

Table 4.2 Thoroughfare Type Descriptions

Thoroughfare Type	Functional Definition
Freeway/Expressway/ Parkway	Freeways are high-speed (50 mph +), controlled-access thoroughfares with grade-separated interchanges and no pedestrian access. Includes tollways, expressways and parkways that are high- or medium-speed (45 mph +), limited-access thoroughfares with some at-grade intersections. On parkways, landscaping is generally located on each side and has a landscaped median. Truck access on parkways may be limited.
Rural Highway	High-speed (45 mph +) thoroughfare designed both to carry traffic and to provide access to abutting property in rural areas. Intersections are generally at grade.
Boulevard (see Chapters 8, 9 and 10 for design guidance)	<p>Walkable, low-speed (35 mph or less) divided arterial thoroughfare in urban environments designed to carry both through and local traffic, pedestrians and bicyclists. Boulevards may be long corridors, typically four lanes but sometimes wider, serve longer trips and provide pedestrian access to land. Boulevards may be high-ridership transit corridors. Boulevards are primary goods movement and emergency response routes and use vehicular and pedestrian access management techniques. Curb parking is encouraged on boulevards.</p> <p>Multiway boulevards are a variation of the boulevard characterized by a central roadway for through traffic and parallel access lanes accessing abutting property, parking and pedestrian and bicycle facilities. Parallel access lanes are separated from the through lanes by curbed islands with landscaping; these islands may provide transit stops and pedestrian facilities. Multiway boulevards often require significant right of way.</p>
Avenue (see Chapters 8, 9 and 10 for design guidance)	Walkable, low-to-medium speed (25 to 35 mph) urban arterial or collector thoroughfare, generally shorter in length than boulevards, serving access to abutting land. Avenues serve as primary pedestrian and bicycle routes and may serve local transit routes. Avenues do not exceed 4 lanes, and access to land is a primary function. Goods movement is typically limited to local routes and deliveries. Some avenues feature a raised landscaped median. Avenues may serve commercial or mixed-use sectors and usually provide curb parking.
Street (see Chapters 8, 9 and 10 for design guidance)	Walkable, low speed (25 mph) thoroughfare in urban areas primarily serving abutting property. A street is designed to (1) connect residential neighborhoods with each other, (2) connect neighborhoods with commercial and other districts and (3) connect local streets to arterials. Streets may serve as the main street of commercial or mixed-use sectors and emphasize curb parking. Goods movement is restricted to local deliveries only.
Rural Road	Low speed (25 to 35 mph) thoroughfare in rural areas primarily serving abutting property.
Alley/Rear Lane	Very low-speed (5 to 10 mph) vehicular driveway located to the rear of properties, providing access to parking, service areas and rear uses such as secondary units, as well as an easement for utilities.

Shaded cells represent thoroughfare types that are not addressed in this report.

Table 4.3 Relationship Between Functional Classification and Thoroughfare Type

Functional Classification	Thoroughfare Types						
	FREEWAY/ EXPRESS- WAY/PARK- WAY	RURAL HIGHWAY	BOULEVARD	AVENUE	STREET	RURAL ROAD	ALLEY/REAR LANE
Principal Arterial							
Minor Arterial							
Collector							
Local							

Shaded cells represent thoroughfare types that are not addressed in this report.

boulevards serve an arterial function, avenues may be arterials or collectors and streets typically serve a collector or local function in the network.

More detailed descriptions of the general design parameters and desired operating characteristics of the thoroughfare types are given in **Table 4.4**. As mentioned above, this document focuses on the three types that can be considered urban thoroughfares: boulevards, avenues and streets. Those thoroughfare types serving areas with traditional urban characteristics are suitable for the four urban context zones C-3, C-4, C-5 and C-6.

Chapter 5 provides an overview of the design process and identifies how the selection of context zones and thoroughfare types relates to each stage of thoroughfare design. Chapter 6 presents design parameters and criteria for each thoroughfare type based on a combination of functional class, context zone and whether the surrounding land use is predominantly commercial or residential.

Works Cited

American Association of State Highway and Transportation Officials. 2004. *A Policy on the Geometric Design of Highways and Streets, 5th edition*. Washington, DC: AASHTO.

Duany, Andres. 2000. "A Theory of Urbanism." *Scientific American* (December).

Duany, Andres. 2002. *Journal of Urban Design*, Special Edition Dedicated to the Transect.

Institute of Transportation Engineers. 2010. *Promoting Sustainable Transportation Through Site Design: An ITE Recommended Practice*. Washington, DC: ITE.

Sources of Additional Information

Bosselman, MacDonald and Kronmeyer. *Environmental Quality of Multiple Roadway Boulevards—Monograph 53*. Berkeley, CA: Institute of Urban and Regional Development, University of California at Berkeley. April 1997.

Duany, Andres and, Sandy Sorlien and William Wright. *SmartCode—A Comprehensive Form-Based Planning Ordinance*, Version 9.2. 2008.

Jacobs, Allen B. *Great Streets*. MIT Press. 2001.

Jacobs, Allen B., Elizabeth MacDonald and Yodan Rofe. *The Boulevard Book: History, Evolution, Design of Multiway Boulevards*. MIT Press. 2003.

Table 4.4 Urban Thoroughfare Characteristics

Urban Thoroughfare Type	Number of Through Lanes	Desired Operating Speed (mph)	Transit Service Emphasis	Median	Driveway Access	Curb Parking	Pedestrian Facilities [1]	Bicycle Facilities	Freight Mvmt. [2]
Freeway	4 to 6+	45–65	Express	Required	No	No	No	Optional separated pathway or shoulder	Regional truck route
Expressway/Parkway	4 to 6	45–55	Express	Required	No	No	Optional separated pathway	Optional separated pathway or shoulder	Regional truck route
Boulevard	4 to 6	30–35	Express and Local	Required	Limited	Optional	Sidewalk	Bike lanes or parallel route	Regional truck route
Multiway Boulevard	4 to 6	25–35	Express and Local	Required on access lanes	Yes from access lane	Yes on access roadway	Sidewalk		Regional route/local deliveries only on access roadway
Avenue	2 to 4	25–30	Local	Optional	Yes	Yes	Sidewalk	Bike lanes or shared	Local truck route
Street	2	25	Local or none	No	Yes	Yes	Sidewalk	Shared	Local deliveries only
Rural Road	2	25–35	Local or none	No	Yes	No	No	Shared or shoulder	Local deliveries only
Local Street	2	25	Local or none	No	Yes	Yes	Sidewalk	Shared	Local deliveries only
Alley/Rear Lane	1	5–10	None	No	Yes	No	Shared	Shared	Local deliveries only

Shaded cells represent thoroughfare types that are not addressed in this report.

Notes:

[1] Boulevard, Multiway Boulevard, Avenue, and Street thoroughfare types have sidewalks on both sides. Sidewalk width varies as a function of context zone, fronting land use and other factors.

[2] Freight movement is divided into three categories: 1) Regional truck route, 2) Local truck route and 3) Local deliveries only. Cells show highest order of truck movement allowed.

PART 3

Design

- 32 Vel
- 16 Pec

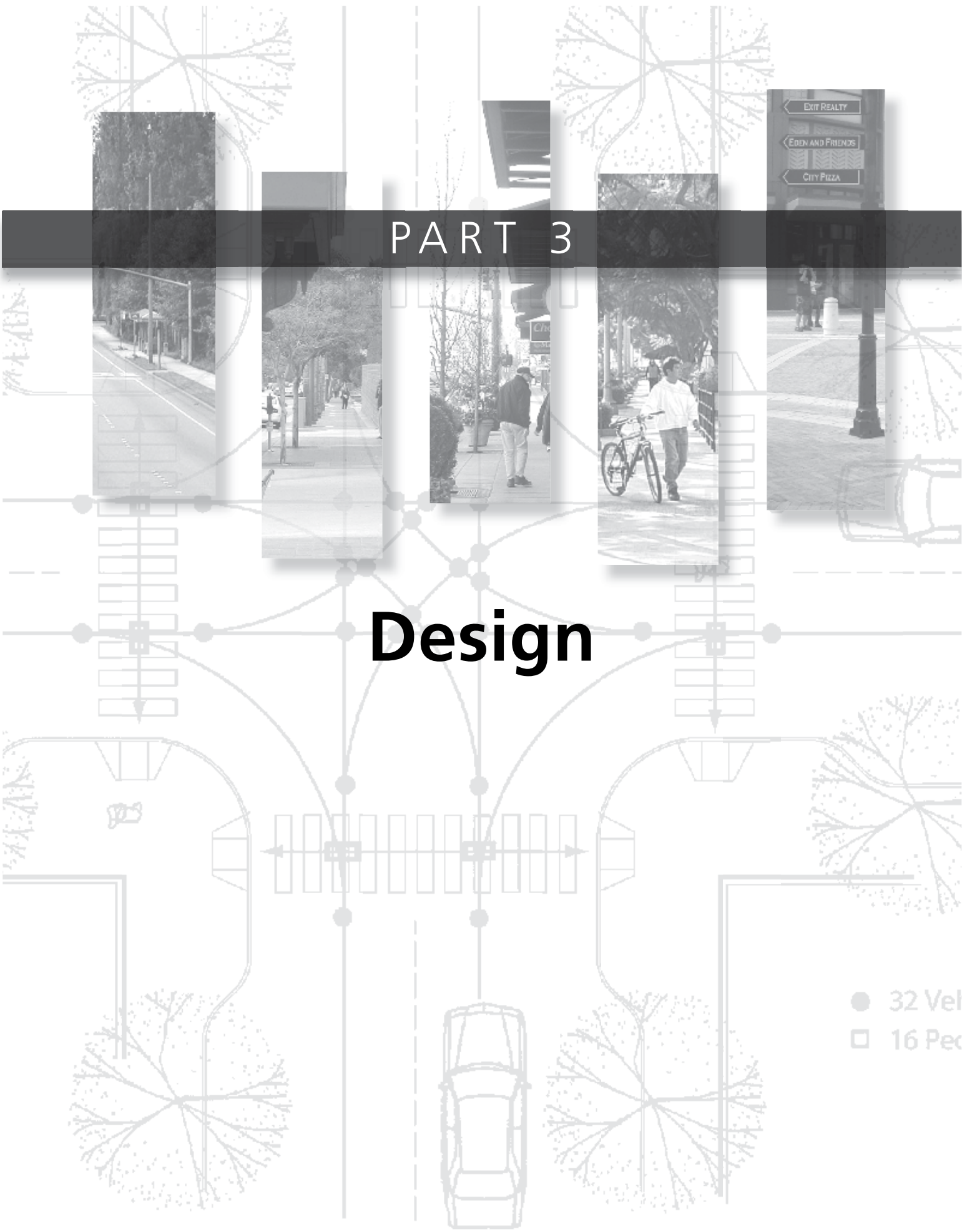

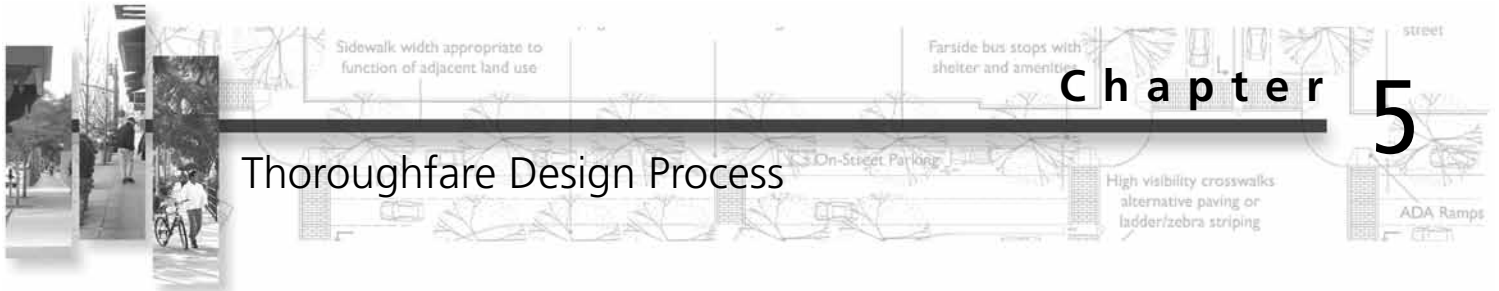

Purpose

This chapter outlines a five-stage process for designing thoroughfares in walkable urban contexts where the community has determined that the character of the thoroughfare and its integration with its surroundings are a high priority. It also presents an approach to designing thoroughfares within constrained rights of way and discusses the flexibility the designer has in applying design parameters. While the focus of this report's approach to design is on walkable thoroughfares in mixed-use areas, the design process presented in this chapter is applicable to all types of areas and thoroughfares, regardless of their modal emphasis.

This chapter presents design criteria that form the basis for the design guidance presented in subsequent chapters. As with the design process, the fundamental design criteria and the flexibility inherent in the interpretation and application of the criteria are applicable to all types of thoroughfares in all types of contexts.

Applicability of Design Criteria

The guidance presented in this report focuses on the design of urban thoroughfares in walkable contexts. As with the design process, the fundamental design criteria and the flexibility inherent in the interpretation and application of the criteria is applicable to all types of thoroughfares in all types of contexts. However, most of the guidance is also applicable to thoroughfares in other contexts where vehicle travel may be a priority. When designing a thoroughfare in a walkable area or a vehicle mobility priority thoroughfare, the practitioner can use this report to identify the sections with relevant and applicable considerations and guidance. If not identified in the report, the guidance provided in the AASHTO *A Policy for the Geometric Design of Highways and Streets*, otherwise known as the "Green Book" (2004), is recommended.

Objectives

This chapter:

1. Describes the various components of the thoroughfare and describes fundamental features of CSS in thoroughfare design;
2. Defines terms that are used in the thoroughfare design process;
3. Provides an overview and describes the five stages of the thoroughfare design process; and
4. Outlines a process for designing thoroughfares in constrained rights of way.

Definitions

Walkable urban thoroughfare design requires attention to many elements of the public right of way and how these elements integrate with adjoining properties. To assist the designer in successfully assembling the elements of the thoroughfare, this report organizes definitions, design principles and criteria into four sections corresponding to the components of a thoroughfare. The three components that comprise the cross-section of the thoroughfare are illustrated in **Figure 5.1** (context, streetside and traveled way), while the fourth component, intersections, is discussed below.

Figure 5.2 illustrates many of the fundamental elements of walkable thoroughfare design, including elements in the traveled way and streetside, and as part of the context.

Each of the components can be described as follows:

- Context—encompasses a broad spectrum of environmental, social, economic and historical aspects of a community and its people. All of these aspects are important in applying CSS principles to thoroughfare design. Thus, context can be the built environment or part of the natural environment. The built environment consists of properties and activities within and adjacent to the public right of way and the thoroughfare it-

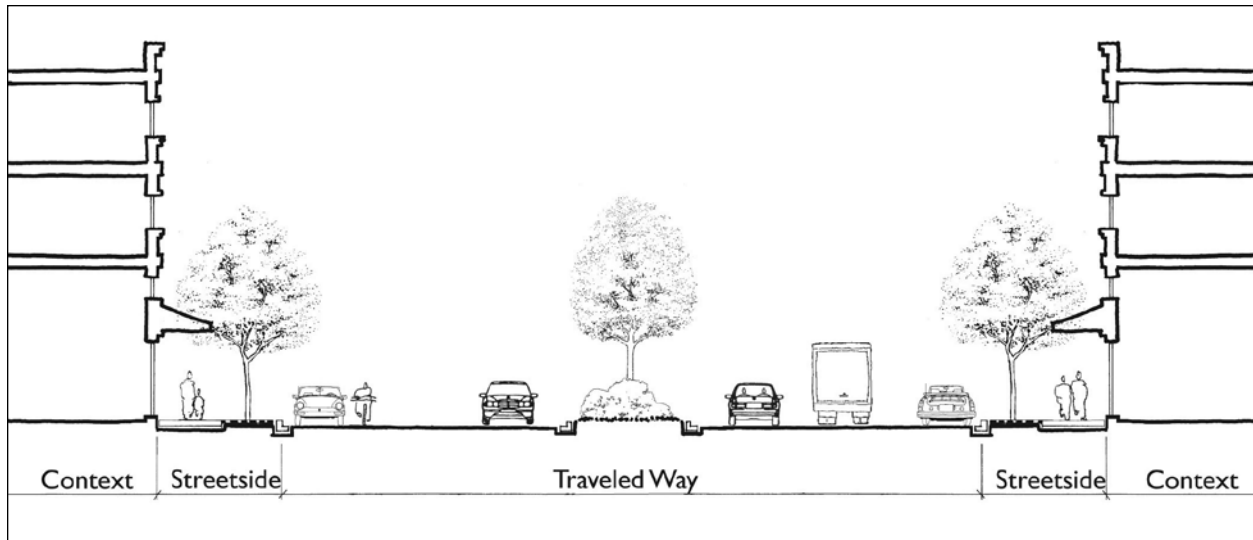

Figure 5.1 Components of an urban thoroughfare. Source: Community, Design + Architecture.

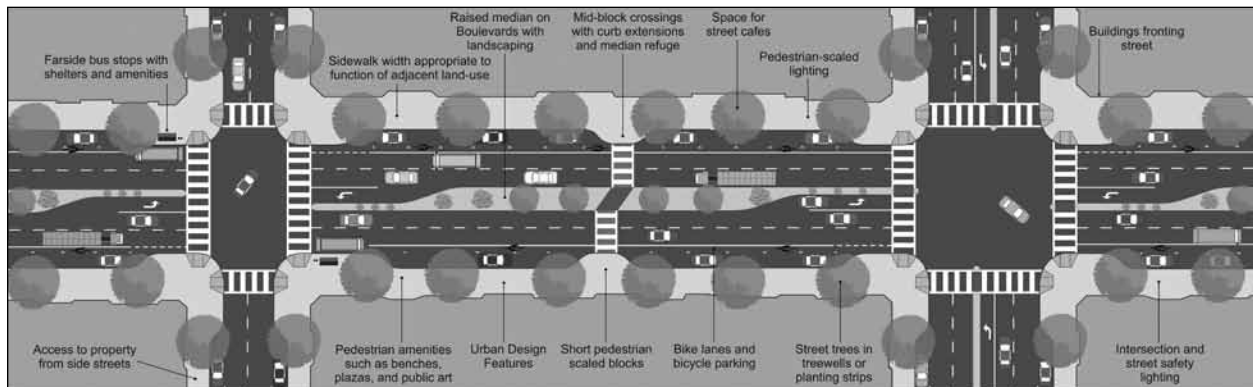

Figure 5.2 An illustration of the elements of a context sensitive thoroughfare. Source: Concept by Community, Design + Architecture, illustration by Digital Media Productions.

self, with surroundings that contribute to characteristics that define the context zone.

Buildings, landscaping, land use mix, site access and public and semipublic open spaces are the primary shaping elements of the built context. The natural environment includes features such as water or topography. In both environments, context can reflect historic or other protected resources. An urban thoroughfare will often change as the context changes from one zone to another. The thoroughfare itself and the activity it handles become part of the context after it is completed. Finally, all contexts whether built or natural, include the equally important elements

of economics, time, community perspective, political positions, trade-offs and a multitude of other factors that will directly or indirectly influence the shaping of the context and thoroughfare design.

- Streetside—the public right of way typically includes planting area and sidewalk, from the back of the curb to the front property line of adjoining parcels. The streetside is further divided into a series of zones that emphasize different functions, including frontage, throughway, furnishings and edge zones (Table 5.1 and Chapter 8 provide detailed descriptions). The function of streetside zones and the level of pedestrian use of

Table 5.1 Definition of Terms and Concepts in Chapter 5

Term or Concept	Definition
Frontage Zone	One of the zones comprising the streetside, the frontage zone is the space between the pedestrian travel way and building faces or private property. At a minimum it provides a buffer distance from vertical surfaces or walls and allows people to window shop or enter/exit buildings without interfering with moving pedestrians. The frontage zone provides width for overhanging elements of adjacent buildings such as awnings, store signage, bay windows and so forth. If appropriate width is provided, the frontage zone may accommodate a variety of activities associated with adjacent uses, such as outdoor seating or merchant displays.
Throughway Zone	The streetside zone in which pedestrians travel. The throughway must provide a minimum horizontal and vertical clear area in compliance with PROWAG accessible route requirements.
Furnishings Zone	The furnishings zone is a multipurpose area of the streetside. It serves as a buffer between the pedestrian travel way and the vehicular area of the thoroughfare within the curbs, and it provides space for streetside appurtenances such as street trees, planting strips, street furniture, utility poles, sidewalk cafes, sign poles, signal and electrical cabinets, phone booths, fire hydrants, bicycle racks and bus shelters.
Edge Zone	The edge zone, sometimes also referred to as the “curb zone,” is the transition area between the thoroughfare traveled way and the furnishings zone of the streetside and provides space for the door swing from vehicles in the parking lane, for parking meters and for the overhang of diagonally parked vehicles.
Right of way	Right of way is the publicly owned land within which a thoroughfare can be constructed. Outside of the right of way, the land is privately owned and cannot be assumed to be available for thoroughfare construction without acquiring the land through dedication or purchase.

(See Chapters 8 and 9 for further definitions and design guidelines for the components of the streetside and the traveled way.)

the streetside are directly related to the activities generated by the adjacent context.

- Traveled way—the public right of way between curbs that includes parking lanes and the travel lanes for private vehicles, goods movement, transit vehicles and bicycles. Medians, turn lanes, transit stops and exclusive transit lanes, curb and gutter and loading/unloading zones are included in the traveled way (see Chapter 9 for detailed descriptions).
- Intersections—the junction where two or more public streets meet and where pedestrians share the traveled way. Intersections are characterized by a high level of activity and shared use, multimodal conflicts, complex movements and special design treatments (Chapter 10 contains detailed descriptions).

This chapter uses terms that are commonly used in transportation planning and engineering and introduces new terms and concepts that require definition.

Overview of the Design Process

The context sensitive thoroughfare design process presented in this report encompasses the project development steps from developing project concepts to final design. Briefly introduced in Chapter 2, the design process is composed of the five stages shown in **Figure 5.3**. While this report presents the process in five discrete stages for simplicity, the thoroughfare design process is an iterative process that requires collaboration with the public, stakeholders and a multidisciplinary team of professionals. As stated earlier, this process is applicable for the design of all thoroughfare types under any context.

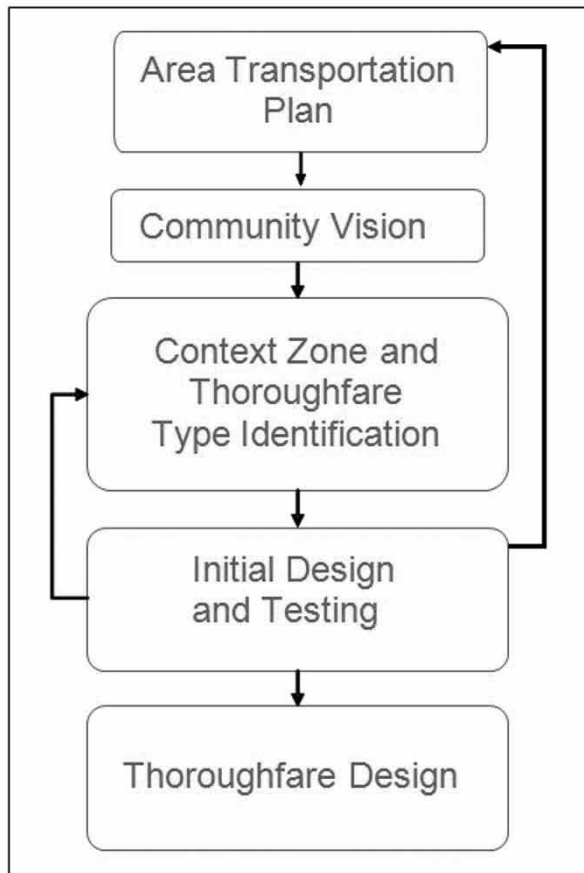

Figure 5.3 Thoroughfare design stages. Source: Kimley-Horn and Associates, Inc.

Stage 1: Review or develop an area transportation plan.

An area transportation plan is a long-range plan based on a public/stakeholder process that establishes goals and objectives for the area, town, or region. The plan results in the pattern of the thoroughfare network, the initial sizing of individual thoroughfares and prioritization of transportation improvements.

The area transportation plan entails development of land use and travel demand forecasts and testing of network alternatives in considering context and area objectives. Often this stage is already available and serves as a direction or resource for the thoroughfare designer. This first stage provides the overall basis for thoroughfare design. The transportation plan establishes guiding principles and policies for the broader community and region. It

develops and evaluates the network to ensure the transportation system accommodates projected land use growth.

The plan should identify performance measures for each mode of transportation at the intersection, corridor and network level and should identify how the network supports the community’s key goals.

The plan should identify and prioritize discrete thoroughfare projects from which the project development process begins. If an area transportation plan has not been prepared, one should be prepared as part of the thoroughfare design process. Area transportation plans can be in the form of regional transportation plans, comprehensive or general plans, or focused district, area, or specific plans. Chapter 3 provides background and guidance on network systems and design.

Stage 2: Understand community vision for context and thoroughfare.

Understanding the vision, goals and objectives of the place a thoroughfare serves is a critical step. This includes understanding the context as well as the thoroughfare’s role in the transportation system. Context sensitive thoroughfare design considers today’s conditions but also reflects plans for the future.

In this stage, the designer collaborates with the public, stakeholders and a multidisciplinary team to develop goals and objectives for the project.

If the community in which the project is located has developed a vision and established goals and objectives, this stage entails a thorough knowledge and understanding to ensure that the project achieves the vision. This stage requires review of planning documents, transportation and circulation plans, and land use and zoning codes. Through the community vision, a multidisciplinary team can determine both the existing and future context for the area served by the thoroughfare. It is the future context that defines the long-term transportation and place-making function of the thoroughfare.

If the community lacks a vision, desires a change, or requires further detail in the project area, this is an opportunity to use a public and/or stakeholder process to answer questions that will form the basis of a vision: What do we want the community to be? What do we want the community to look like? How do we want the community to function? Frequently, it is desirable to use a participatory process to develop concepts and alternatives, even if a vision exists. This establishes public ownership in the project and helps meet the requirements of the National Environmental Policy Act (NEPA), where applicable.

The process for working with the public and stakeholders to develop a vision is outside the scope of this report. However, there are resources available to explain the process such as *Public Involvement Techniques for Transportation Decision-Making* by the U.S. DOT Federal Transit Administration.

Stage 3: Identify compatible thoroughfare types and context zones.

Stage 3 determines the compatibility between the existing and future context and the appropriate thoroughfare type. It considers land use and transportation integration, modal requirements, place-making objectives and the functional roles of the adjacent land use and street.

This report provides the tools for this stage in Chapter 4—a framework for urban thoroughfare design. Stage 3 relies on an understanding of the existing and future context identified in Stage 2. Stages will result in the identification of opportunities, design controls and constraints that will dictate thoroughfare design elements and project phasing.

Chapter 4 guides the thoroughfare design team through the process of identifying context and alternative thoroughfare types best suited for the identified context zone. The initial relationship between the context zone and the thoroughfare is tentative, leading to stage 4 of the process.

Stage 3 entails close examination of modal requirements (such as transit, bicycle, pedestrian and freight

needs) and establishes design controls such as traffic volumes, speed, corridorwide operations, right-of-way constraints and other fundamental engineering controls (Chapter 7 provides additional information). This stage might be an iterative process that compares needs with constraints, identifies trade-offs and establishes priorities. Specific steps in this stage include:

1. Determining the context zone(s) within which each segment of the thoroughfare is located. The context zones, whether existing or projected, are determined from a community or regional comprehensive plan if one is available. In the absence of such a plan, the context zones can be derived from the description of the function and configuration, the type of the buildings fronting the thoroughfare and whether the context is predominantly residential or commercial. Note that the context zone will likely vary throughout the length of a corridor, requiring the thoroughfare to be divided into segments that may have varying design parameters and elements. **Table 4.1** in Chapter 4 can assist in identifying context zones; and
2. Selecting the appropriate thoroughfare type based on context zone and purpose of the thoroughfare as determined from the area plan, including its functional classification designation.

Tables 4.2, 4.3 and 4.4 in the previous chapter assist a multidisciplinary team in developing the character and general design parameters of the thoroughfare. The thoroughfare's functional classification establishes the role of the thoroughfare in the transportation network. The thoroughfare type helps determine certain design controls such as target speed, the physical design of the thoroughfare and the design elements that serve the activities of the adjacent uses. For urban thoroughfares in walkable communities, the combination of thoroughfare type, functional classification and context zone is used to select the appropriate general design parameters presented in Chapter 6 and the streetside, traveled way and intersection design guidelines presented in Chapters 8 through 10, respectively.

Stage 4: Develop and test the initial thoroughfare concept.

Understanding the balance between the regional functions and local needs of the thoroughfare is a key factor in selecting the appropriate design criteria and prepar-

ing the initial thoroughfare concept. Stage 4 determines whether the boulevard, avenue, or street concept of initial width is appropriate. This step in the process feeds back into the previous stages if the evaluation of the concept results in the need to change the initial thoroughfare type or modify the system design. In this stage a multidisciplinary team uses the design parameters identified by the context zone/thoroughfare type combination selected in stage 3 (Tables 6.1 through 6.4 in Chapter 6) to determine the basic elements of the thoroughfare that affect its width, including on-street parking, bicycle facilities, number and width of travel lanes, median and general configuration of the streetside.

In stage 4, initial thoroughfare concepts are developed by establishing vital parameters such as speed, number of lanes, travel way and streetside widths, right of way and other design parameters. In this stage, the thoroughfare's function beyond the limits of the project are considered along with its multimodal and place-making functions to ensure both the community vision and the overall network operate as planned.

The team then tests and validates the initial concept at the corridor and network level of performance. A successful urban thoroughfare concept is one that, when viewed as part of an overall system, maintains acceptable systemwide performance even though the individual thoroughfare intersections may experience congestion. Network performance should include multimodal performance measures. Chapter 3 describes the role of the thoroughfare in the network and references network-connectivity guidelines.

Evaluation of the thoroughfare at the corridor and network level will either validate the initial concept or indicate the need to revisit the context zone/thoroughfare type relationship or modify the design parameters. The evaluation might even indicate the need to revise regional or subregional land use and circulation plans.

Stage 5: Develop a detailed thoroughfare design.

Once a successful initial concept has been developed and validated, the process leads to the final step of

The evaluation and initial designs in the previous stages lead to stage 5—refinements and development of a detailed thoroughfare design that reflects the project objectives. This step culminates in final engineering design and environmental approvals.

detailing the thoroughfare design. Stage 5 involves using the guidance to integrate the design of the street components, context, streetside, travelway and intersections. As with any design process, this stage is iterative, resulting in a thoroughfare plan and cross-sections. This stage then leads into preliminary and final engineering. Specific steps in this stage include:

1. *Identifying available right of way and other constraints.*

In new developments, this step establishes the necessary right of way to accommodate the thoroughfare type and its desirable elements. In existing built areas, this step identifies the available right of way as an input to the thoroughfare design process. It is important to identify any other constraints that will affect the design, such as utility placement.

In existing areas, an initial cross-section of the desirable streetside and traveled way elements is prepared (see design examples in Chapter 6) and compared with the available right of way. If the total width of the desirable design elements exceeds the right of way, determine the feasibility of acquiring the necessary right of way or eliminating or reducing nonvital elements.

2. *Design the traveled way elements.*

First identify and select the design controls appropriate for the thoroughfare type and context zone identified in stage 3. These controls include target speed (affects sight distance and alignment), control/design vehicle (affects lane width and intersection design) and modal requirements, such as level of pedestrian activity, parking, bike routes, primary freight routes, or transit corridor and so forth. A trade-offs evaluation may be necessary if right of way is constrained. The design controls and context, along with the available right of way, assist in the selection of the appropriate dimensions for each design element.

3. *Design the streetside elements.*

The design of the streetside elements requires understanding the characteristics and activity of the adjacent existing or future context. For example, does or will the context include ground floor retail or restaurants that require a wider frontage zone to accommodate street cafes? Does or will the thoroughfare include a transit corridor that requires a wider furnishings zone to accommodate waiting areas and shelters? This report provides general guidance on the optimal and constrained streetside width used initially, but the actual design might require more analysis of existing and future activity levels.

4. *Assemble the thoroughfare components.*

This is an iterative process, particularly in constrained rights of way. This process entails identifying trade-offs to accommodate the streetside and traveled way elements within the right of way. It is important to refer back to the community vision stage to understand and evaluate the trade-offs. The last section of this chapter provides an approach to design thoroughfares in constrained conditions.

Flexibility in Application of Design Criteria

Flexibility in the application of design criteria requires an understanding of the functional basis for the criteria and the ramifications of changing dimensions or adding/eliminating design elements. Dimensions, whether for elements in the streetside, traveled way, or intersection, should not be applied arbitrarily but should be based on a specific rationale. The concept of design flexibility is not limited to thoroughfares in walkable areas but is a concept that recognizes the unique circumstances of every project under every setting. The challenge that this concept presents is aptly summarized in the Federal Highway Administration's *Flexibility in Highway Design* (1997):

For each potential project, designers are faced with the task of balancing the need for the highway improvement with the need to safely integrate the design into the surrounding natural and human environments.

To correctly apply flexibility, the thoroughfare designer should understand the relationship between a recommended criterion and its role in safety and mobility for all users. The American Association of State Highway and Transportation Officials (AASHTO) emphasizes this requirement in the following quote from *A Guide for Achieving Flexibility in Highway Design* (2004c):

Only by understanding the actual functional basis of the criteria and design values can designers and transportation agencies recognize where, to what extent and under what conditions a design value outside the typical range can be accepted as reasonably safe and appropriate for the site-specific context.

Flexibility is related to the design controls used in the selection of criteria. Design controls recognized by AASHTO include functional classification, location (urban versus rural), traffic volumes and level of service, design vehicle and driver and target speed. All of these design controls are important, regardless of whether the designer believes the thoroughfare design is context sensitive or not.

Design Process in Constrained Right of Way

The nature of thoroughfare design is balancing the desired design elements of the thoroughfare with right-of-way constraints. The thoroughfare designs presented in this report illustrate the desired elements within the cross-section, but actual conditions frequently limit the width of the street. Designing thoroughfares in constrained rights of way requires prioritizing the design elements and emphasizing the higher-priority elements in constrained conditions. Higher-priority design elements are those that help the thoroughfare meet the vision and context sensitive objectives of the community (the objectives established in stage 2). Lower-priority elements have less influence on achieving the objectives and can be relinquished in cases of insufficient right of way.

Often the width of the public right of way varies along the thoroughfare, making the job of the designer even more challenging. When the width of the right of way

varies, it is useful to prioritize design elements and develop a series of varying cross-sections representing:

1. Optimal conditions—sections without right-of-way constraints that can accommodate all desirable elements;
2. Predominant—representing sections of the predominant right-of-way width in the corridor that accommodate all of the higher-priority elements;
3. Functional minimum—representing a typically constrained section where most of the higher-priority elements can be accommodated; and
4. Absolute minimum—representing severely constrained sections where only the highest-priority design elements can be accommodated without changing the type of thoroughfare.

Below the absolute minimum, or if the predominant right of way is equal to or less than the absolute minimum, consider changing the thoroughfare to a different type while attempting to maintain basic function, or consider converting the thoroughfare to a pair of one-way thoroughfares (couplet)—or, further still, consider other solutions that achieve the community vision. This requires recycling through the steps of the design process, potentially requiring a review of the community vision for the thoroughfare and the area transportation plan and/or identifying a new context zone/thoroughfare relationship. If the vision for the corridor is long range, then the necessary right of way should be acquired over time as the adjacent property redevelops. Under these circumstances the optimal (or the predominant) thoroughfare width can be phased in over time, beginning with the functional or absolute minimum design in the initial phase.

In constrained conditions it might be tempting to minimize the streetside width and only provide the minimum pedestrian throughway (5 feet). In urban areas, however, even under constrained conditions, it is critical to provide at least a minimum width furnishing zone to accommodate street trees, utility poles and other appurtenances. Without the furnishings zone, trees, utilities, benches and shelters and other street paraphernalia might encroach into the throughway for pedestrians or result in an inadequate width streetside when the community's vision for the context zone is ultimately achieved.

Table 5.2 provides minimum recommended dimensions for the streetside in constrained conditions, which vary by the predominant land use. In residential areas, the furnishings zone can be a minimum of 3 feet. This width continues to provide a buffer between pedestrians and the traveled way and also allows a minimal width for plantings and utilities. The clear throughway for pedestrians should be a minimum of 5 feet. The frontage zone should be a minimum of 1 foot adjacent to buildings or eliminated adjacent to landscaping. These dimensions result in a minimum residential streetside width of 9 feet.

In predominantly commercial areas with ground floor retail, the furnishings zone minimum width is 4 feet to allow for street trees, utilities and so forth. The clear throughway for pedestrians is a minimum of 6 feet to allow for a higher level of pedestrian activity, and the frontage zone minimum is 2 feet to provide a buffer between moving pedestrians and buildings, resulting in a 12-foot streetside width. When a wider frontage zone is needed (for street cafes and so forth), consider requiring the adjacent property to provide an easement to effectively expand the streetside width.

Works Cited

American Association of State Highway and Transportation Officials. 1997. *Highway Safety Design and Operations Guide*. Washington, DC: AASHTO.

American Association of State Highway and Transportation Officials. 1999. *Guide for the Development of Bicycle Facilities*. Washington, DC: AASHTO.

American Association of State Highway and Transportation Officials. 2002. *Roadside Design Guide*. Washington, DC: AASHTO.

American Association of State Highway and Transportation Officials. 2004a. *Policy on Geometric Design of Streets and Highways*, Fifth Edition. Washington, DC: AASHTO.

American Association of State Highway and Transportation Officials. 2004b. *Guide for the Planning, Design and Operation of Pedestrian Facilities*. Washington, DC: AASHTO.

Table 5.2 Minimum Recommended Streetside Dimensions for Thoroughfares in Walkable Areas Under Constrained Conditions

Streetside Zone	Minimum Dimension
Residential (All Context Zones)	
Edge and Furnishing Zone (Planting Strip, utilities, etc.)	3 feet
Clear Pedestrian Travel Way	5 feet
Frontage Zone	1 foot
Total Minimum Streetside Width:	
Commercial with Ground Floor Retail (All Context Zones)	
Edge and Furnishing Zone (Treewell ¹ , utilities, bus stops, etc.)	4 feet
Clear Pedestrian Travel Way	6 feet
Frontage Zone	2 feet
Total Minimum Streetside Width:	
12 feet	

¹ Plant only small caliper trees (4" diameter when mature) in 4-foot treewells.

The minimum recommended streetside dimensions for thoroughfares in other areas (such as vehicle-oriented areas) should be based on the designer's understanding of the community's objectives, the future desired traversability of the area, the future potential redevelopment of the adjacent property and the need to accommodate all users.

American Association of State Highway and Transportation Officials. 2004c. *A Guide for Achieving Flexibility in Highway Design*. Washington, DC: AASHTO.

Federal Highway Administration, Federal Transit Administration. 1996. *Public Involvement Techniques for Transportation Decision-Making*. Washington DC, FHWA-PD-96-031, September 1996. Accessible via www.fhwa.dot.gov/reports/pittd/cover.htm.

Transportation Research Board, 2004, *Highway Capacity Manual*, Special Report 209, Washington, DC: TRB.

Transportation Research Board. 2008. Dowling, R., et al, *Multimodal Level of Service Analysis for Urban Streets*, NCHRP Report 616. Washington, DC: TRB. Accessible via http://onlinepubs.trb.org/onlinepubs/nchrp/nchrp_rpt_616.pdf.



Thoroughfare Designs for Walkable Urban Areas

Chapter 6

Sidewalk width appropriate to function of adjacent land use

Farside bus stops with shelter and amenities

Visibility crosswalks alternative paving or ladder/zebra striping

ADA Ramps

Purpose

This chapter identifies how design elements can be combined to produce a thoroughfare in urban walkable areas with traditional characteristics. This chapter includes tables of common cross-sectional design elements for thoroughfare types in each context zone and provides design examples under various situations. The variation in design criteria are presented by context zone (C-3 through C-5/6), thoroughfare type (boulevard, avenue and street) and whether the thoroughfare serves a predominantly residential or commercial area with fronting ground floor retail.

The design criteria presented in this chapter focus primarily on thoroughfares in walkable areas, but many of the principles and design examples in this chapter are fully applicable to other areas as well.

Objectives

This chapter:

1. Describes how variables such as context zone and land use type can affect the design of thoroughfares; and
2. Provides design examples that guide the practitioner through the design process.

Basis for Thoroughfare Design Examples

The thoroughfare examples illustrate variations in the traveled way and streetside based on the variables of existing right-of-way constraints, context zone, functional classification, thoroughfare type and predominant surrounding land use and ground floor uses. The general influence of each variable on the design of a thoroughfare is summarized in **Table 6.1**.

General Walkable Thoroughfare Design Parameters

While walkable thoroughfares can be any functional classification of thoroughfare—arterial, collector, or local—this report addresses only arterial and collector thoroughfares. Within those functional classifications, all three thoroughfare types—boulevards, avenues and streets—may be employed and should be designed to be walkable. The remainder of this chapter provides basic design criteria for developing initial cross-section characteristics. However, despite the presentation of these criteria, designers are reminded that each thoroughfare design is unique, and the ultimate design needs to address the context, objectives, priorities and design con-

Table 6.1 Effect of Variables on Thoroughfare Design Elements

Variable	Effect on Design Elements
Context Zone	A designation of design character that affects general design parameters including the selection of thoroughfare type, target speed and the width and treatment of certain streetside elements.
Thoroughfare Type	Affects general design parameters of thoroughfares including target speed, number of through lanes, basic travel lane width, medians and the width of certain streetside elements.
Predominant Land Use and Ground Floor Use	Divided into predominantly residential or commercial. Residential areas affect streetside width, parking lane width, landscaping and building setback. Commercial, particularly where there is ground floor retail, affects the width of the streetside uses for pedestrian facilities, bus stops, landscaping, outdoor cafes and so forth. Adjacent land uses, pedestrian activity, building orientation and so forth directly influence the target speed (and related design elements).

Table 6.2 Selected Characteristics of Walkable Thoroughfares

Characteristic	Walkable Thoroughfares	Vehicle-Oriented Thoroughfares
Target speed range	From Table 6.4.	25–35 mph.
Pedestrian separation from moving traffic	Curb parking and streetside furnishing zone.	Optional, typically separation achieved with planting strip.
Streetside width	Minimum 9 feet (residential) and 12 feet (commercial) to accommodate sidewalk, landscaping and street furniture.	Minimum 5 feet.
Block lengths	200–660 feet.	Up to one-quarter mile.
Protected pedestrian crossing frequency (pedestrian signals or high-visibility markings at unsignalized crossings)	200–600 feet.	As needed to accommodate pedestrian demands.
Pedestrian priority at signalized intersection	Pedestrian signals and pedestrian count-down heads, adequate crossing times, shorter cycle lengths and median refuges for very long crossings.	Vehicle priority; may have longer cycle lengths and require two cycles for slower pedestrians to cross wide streets with medians.
Pedestrian crossings	High-visibility crosswalks shortened by curb extensions where there is on-street parking.	Full street width.
Median width	6 feet minimum width at crosswalk, if used as pedestrian refuge, plus 10 feet for left-turn lane, if provided. 14 foot total width for left-turn lane if no refuge needed.	14–18 feet for single left-turn lane; 26–30 feet for double left-turn lane.
Vehicular access across sidewalks	24 feet or less, except if specific frequent design vehicle requires added width.	As needed.
Curb parking	Normal condition except at bus stops and pedestrian crossings.	None.
Curb return radius	10–30 feet; low-speed channelized right turns where other options are unworkable.	30–75 feet; high-volume turns channelized.

Table 6.3 Design Elements Influenced by Functional Classification

Characteristic	Arterials	Collectors
Network Characteristic		
Continuity	Longer, extending intercity, interarea or serving major corridors.	Shorter, connecting neighborhoods and providing local connections to activity centers; usually 1–2 miles.
Trip lengths	Longer (local and regional).	Shorter (local only).
Role in bicycle network	Designated bikeway with bike lanes or shared lanes depending on context and target speed.	Bike lanes, signed routes, or shared facilities.
Segment Characteristic		
Target speed range (see Table 6.4)	30–35 mph.	25–30 mph.
Traffic volumes (daily)	10,000–50,000.	1,000–10,000.
Transit	Major regional fixed guideway corridor, express, or local bus routes.	Local bus service only, where provided.

cept established for the facility and corridor. Consequently, the thoroughfare designs resulting from use of this guidance may deviate from the initial parameters presented here.

For purposes of comparison, **Table 6.2** presents some of the common characteristics that should be provided for all walkable thoroughfares and contrasts these characteristics with those of conventional vehicle-oriented thoroughfares.

While the characteristics for walkable thoroughfares of all functional classifications and thoroughfare types have much in common, the thoroughfare’s functional classification does influence some of the design characteristics, only a few of which affect cross-section. **Table 6.3** compares those design characteristics that vary depending on functional classification.

Table 6.4 presents the recommended initial cross-section and other design criteria to be used in the design of walkable thoroughfares. Chapters 8

though 10 provide additional criteria and discussion on how and when to use the various design elements. While **Table 6.4** focuses on thoroughfares in walkable areas, many of the design elements are applicable in other areas.

Specialized Thoroughfare Designs

This section discusses the design of two specialized types of thoroughfares: main streets and multiway boulevards.

Main Streets

Main streets used to be the principal thoroughfares of American towns, where people could find all types of goods and services. They were the center of commercial, social and civic activities. Main streets thrived up until the 1960s and 70s, when larger-scale, auto-oriented shopping centers became popular. Many communities are revitalizing their main streets to return to a traditional small town mercantile environment or are creating hybrids of traditional and contemporary commercial centers.

Table 6.4 Design Parameters for Walkable Urban Thoroughfares

Thoroughfare Design Parameters for Walkable Mixed-Use Areas									
	Suburban (C-3)						General Urban (C-4)		
	Residential			Commercial			Residential		
	Boulevard [1]	Avenue	Street	Boulevard [1]	Avenue	Street	Boulevard [1]	Avenue	Street
Context									
Building Orientation (entrance orientation)	front, side	front, side	front, side	front, side	front, side	front, side	front	front	front
Maximum Setback [2]	20 ft.	20 ft.	20 ft.	5 ft.	5 ft.	5 ft.	15 ft.	15 ft.	15 ft.
Off-Street Parking Access/Location	rear, side	rear, side	rear, side	rear, side	rear, side	rear, side	rear	rear, side	rear, side
Streetside									
Recommended Streetside Width [3]	14.5–16.5 ft.	14.5 ft.	11.5 ft.	16 ft.	16 ft.	15 ft.	16.5-18.5 ft.	14.5 ft.	11.5 ft.
Minimum sidewalk (throughway) width	6 ft.	6 ft.	6 ft.	6 ft.	6 ft.	6 ft.	8 ft.	6 ft.	6 ft.
Pedestrian Buffers (planting strip exclusive of travel way width) [3]	8 ft. planting strip	6–8 ft. planting strip	5 ft. planting strip	7 ft. tree well	6 ft. tree well	6 ft. tree well	8 ft. planting strip	8 ft. planting strip	6 ft. planting strip
Street Lighting	For all thoroughfares in all context zones, intersection safety lighting, basic street lighting, and pedestrian-scaled lighting is recommended. See Chapter 8 (Streetside Design Guidelines) and Chapter 10 (Intersection Design Guidelines).								
Traveled Way									
Target Speed (mph)	25–35	25–30	25	25–35	25–35	25	25–35	25–30	25
Number of Through Lanes [5]	4–6	2–4	2	4–6	2–4	2	4–6	2–4	2
Lane Width [6]	10–11 ft.	10–11 ft.	10–11 ft.	10–12 ft.	10–11 ft.	10–11 ft.	10–11 ft.	10–11 ft.	10–11 ft.
Parallel On-Street Parking Width [7]	7 ft.	7 ft.	7 ft.	8 ft.	7-8 ft.	7-8 ft.	7 ft.	7 ft.	7 ft.
Min. Combined Parking/Bike Lane Width	13 ft.	13 ft.	13 ft.	13 ft.	13 ft.	13 ft.	13 ft.	13 ft.	13 ft.
Horizontal Radius (per AASHTO) [8]	200–510 ft.	200–330 ft.	200 ft.	200–510 ft.	200–510 ft.	200 ft.	200–510 ft.	200–330 ft.	200 ft.
Vertical Alignment	Use AASHTO minimums as a target, but consider combinations of horizontal and vertical per AASHTO Green Book.								
Medians [9]	4–18 ft.	Optional 4–16 ft.	None	4–18 ft.	Optional 4–18 ft.	None	4–18 ft.	Optional 4–16 ft.	None
Bike Lanes (min./preferred width)	5 ft./6 ft.	5 ft./6 ft.	5 ft./6 ft.	5 ft./6 ft.	5 ft./6 ft.	5 ft./6 ft.	5 ft./6 ft.	5 ft. / 6 ft.	5 ft. / 6 ft.
Access Management [10]	Moderate	Low	Low	High	Moderate	Low	Moderate	Low	Low
Typical Traffic Volume Range (ADT) [11]	20,000–35,000	1,500–25,000	500–5,000	20,000–50,000	1,500–35,000	1,000–10,000	10,000–35,000	1,500–20,000	500–5,000
Intersections									
Roundabout [12]	Consider urban single-lane roundabouts at intersections on avenues with less than 20,000 entering vehicles per day, and urban double-lane roundabouts at intersections on boulevards and avenues with less than 40,000 entering vehicles per day.								
Curb Return Radii/Curb Extensions and Other Design Elements	Refer to Chapter 10 (Intersection Design Guidelines)								

Table 6.4 Notes:

- Multiway boulevards are a special form of boulevards. Generally they add one-way, 16–20 foot wide access lanes adjacent to the outer curb and separated from the through traffic lanes by a longitudinal island at least 6 ft. wide (10 ft. if accommodating transit stops). Access lanes have curb parallel parking plus one moving traffic/bike lane with a target speed of 15–20 mph. All vehicular traffic on the access lanes is local. See Chapter 6 section on multiway boulevards for additional information.
- For all context zones with predominantly commercial frontage, this table shows the maximum setback for buildings with ground floor retail. In suburban contexts, office buildings are typically set back 5 ft. further than retail buildings to provide a privacy buffer. In general urban and urban center/core areas, office buildings are set back 0–5 ft. Setback exceptions may be granted for important civic buildings or unique designs.
- Streetside width includes edge, furnishing/planting strip, clear throughway, and frontage zones. Refer to Chapter 8 (Streetside Design Guidelines) for detailed description of sidewalk zones and widths in different context zones and on different thoroughfare types. Dimensions in this table reflect widths in unconstrained conditions. In constrained conditions streetside width can be reduced to 12 ft. in commercial areas and 9 ft. in residential areas (see Chapter 5 on designing within constrained rights of way).
- Desired target speeds on avenues serving C-4 and C-5/6 commercial main streets with high pedestrian activity should be 25 mph.
- Six lane facilities are generally undesirable for residential streets because of concerns related to neighborhood livability (i.e., noise, speeds, traffic volume) and perceptions as a barrier to crossing. Consider a maximum of four lanes within residential neighborhoods.
- Lane width (turning, through and curb) can vary. Most thoroughfare types can effectively operate with 10–11 ft. wide lanes, with 12 ft. lanes desirable on higher speed transit and freight facilities. Chapter 9 (Traveled Way Design Guidelines) (lane width section) identifies the considerations used in selecting lane widths. Curb lane width in this report is measured to curb face unless gutter pan/catch basin inlets do not accommodate bicycles, then it is measured from the edge of travel lane. If light rail transit or streetcars are to be accommodated in a lane with motor vehicles, the minimum lane width should be the

Table 6.4 Design Parameters for Walkable Urban Thoroughfares (continued)

Thoroughfare Design Parameters for Walkable Mixed-Use Areas									
	General Urban (C-4)			Urban Center/Core (C-5/6)					
	Commercial			Residential			Commercial		
	Boulevard [1]	Avenue	Street	Boulevard [1]	Avenue	Street	Boulevard [1]	Avenue	Street
Context									
Building Orientation (entrance orientation)	front	front	front	front	front	front	front	front	front
Maximum Setback [2]	0 ft.	0 ft.	0 ft.	10 ft.	10 ft.	10 ft.	0 ft.	0 ft.	0 ft.
Off-Street Parking Access/Location	rear, side	rear, side	rear, side	rear	rear	rear, side	rear	rear	rear, side
Streetside									
Recommended Streetside Width [3]	19 ft.	16 ft.	16 ft.	21.5 ft.	19.5 ft.	16 ft.	21.5 ft.	19.5 ft.	16 ft.
Minimum sidewalk (throughway) width	8 ft.	6 ft.	6 ft.	10 ft.	9 ft.	6 ft.	10 ft.	9 ft.	6 ft.
Pedestrian Buffers (planting strip exclusive of travel way width) [3]	7 ft. tree well	6 ft. tree well	6 ft. tree well	7 ft. tree well	6 ft. tree well	6 ft. tree well	7 ft. tree well	6 ft. tree well	6 ft. tree well
Street Lighting	For all thoroughfares in all context zones, intersection safety lighting, basic street lighting, and pedestrian-scaled lighting is recommended. See Chapter 8 (Streetside Design Guidelines) and Chapter 10 (Intersection Design Guidelines).								
Traveled Way									
Target Speed (mph)	25–35	25–30 [4]	25	25–35	25–30	25	25–35	25–30 [4]	25
Number of Through Lanes [5]	4–6	2–4	2–4	4–6	2–4	2–4	4–6	2–4	2–4
Lane Width [6]	10–12 ft.	10–11 ft.	10–11 ft.	10–11 ft.	10–11 ft.	10–11 ft.	10–11 ft.	10–11 ft.	10–11 ft.
Parallel On-Street Parking Width [7]	8'	7–8 ft.	7–8 ft.	7 ft.	7 ft.	7 ft.	8 ft.	8 ft.	7–8 ft.
Min. Combined Parking/Bike Lane Width	13 ft.	13 ft.	13 ft.	13 ft.	13 ft.	13 ft.	13 ft.	13 ft.	13 ft.
Horizontal Radius (per AASHTO) [8]	200–510 ft.	200–330 ft.	200 ft.	200–510 ft.	200–330 ft.	200 ft.	200–510 ft.	200–330 ft.	200 ft.
Vertical Alignment	Use AASHTO minimums as a target, but consider combinations of horizontal and vertical per AASHTO Green Book.								
Medians [9]	4–18 ft.	Optional 4–18 ft.	None	4–18 ft.	Optional 4–16 ft.	None	4–18 ft.	Optional 4–18 ft.	None
Bike Lanes (min./preferred width)	5 ft. / 6 ft.	5 ft. / 6 ft.	5 ft. / 6 ft.	5 ft. / 6 ft.	5 ft. / 6 ft.	5 ft. / 6 ft.	5 ft. / 6 ft.	5 ft. / 6 ft.	5 ft. / 6 ft.
Access Management [10]	High	Low–Moderate	Low–Moderate	Moderate	Low–Moderate	Low–Moderate	High	Low–Moderate	Low–Moderate
Typical Traffic Volume Range (ADT) [11]	15,000–50,000	1,500–30,000	1,000–15,000	15,000–30,000	1,500–20,000	500–5,000	15,000–40,000	1,500–30,000	1,000–15,000
Intersections									
Roundabout [12]	Consider urban single-lane roundabouts at intersections on avenues with less than 20,000 entering vehicles per day, and urban double-lane roundabouts at intersections on boulevards and avenues with less than 40,000 entering vehicles per day.								
Curb Return Radii/Curb Extensions and Other Design Elements	Refer to Chapter 10 (Intersection Design Guidelines)								

width of the transit vehicle plus 1 ft. of clearance on either side. Most modern streetcars or light rail vehicles (LRT) can be accommodated in an 11 or 12 ft. wide lane but designers need to consider the LRT vehicle's "dynamic envelope" when designing on horizontal curves and intersections.

7. An 8 ft. wide parking lane is recommended in any commercial area with a high turnover of parking.
8. For guidance on horizontal radius—see AASHTO's "green book" section on "Minimum Radii for Low Speed Urban Streets—Sharpest Curve Without Superelevation." Dimensions shown above are for noted target speeds and are found on Exhibit 3–16 (Page 151) in *A Policy on Geometric Design of Highways and Streets* (2004), assuming a superelevation of –2.0 percent reflecting typical cross slope. Depending on design vehicle, horizontal curves may require lane widening to accommodate large vehicle off-tracking. See AASHTO's section on "Traveled Way Widening on Horizontal Curves" for guidance.
9. See also Chapter 9 for additional detail on medians. For curb to curb intersection crossing distances of 60 ft. or more, medians should be at least 6 ft. wide to serve as a pedestrian refuge, otherwise the median should be at least 4 ft. wide. Where left turn lanes are to be provided, median widths should be increased by the width of the turn lane(s). Where left turn lanes are not needed (e.g., long blocks) median widths may be as little as 4 ft.
10. Access management involves providing (i.e., managing) access to land development in such a way as to preserve safety and reasonable traffic flow on public streets. Low, moderate and high designations are used for the level of access restrictions. A high level of access management uses medians to restrict mid-block turns, consolidate driveways and control the spacing of intersections. A low level of access management limits full access at some intersections, but generally uses minimal measures to restrict access.
11. These ranges of typical traffic volumes are intended to help determine the characteristics of thoroughfares. Volumes can fluctuate widely on all thoroughfare types. These ranges are not intended to establish guidelines or upper bounds for designing thoroughfares.
12. Double-lane roundabouts are not recommended in urban areas with high levels of pedestrians and bicyclists.



Figure 6.1 Buildings on main streets are typically located on small lots and front the streetside. Parking is either located in the rear of the building, on-street, or in nearby public parking facilities. Source: Kimley-Horn and Associates, Inc.



Figure 6.2 The design of main streets supports active uses such as social interaction, street cafes, window shopping and strolling. Source: Kimley-Horn and Associates, Inc.

The value of today's main streets is summarized in this quote from Portland, Oregon Metro's *Main Street Handbook*:

“Main streets flourish because they provide a variety of goods and services, a pleasant community environment and efficiency for those who frequent them. When people do their shopping at a main street, they simply accomplish more with less travel and may find the experience more entertaining.”

Creating Quality Main Streets

While main streets vary from community to community, there are some universal characteristics. Main streets may be located in any context zone but are most commonly found in suburban (C-3), general urban (C-4) and urban center (C-5) contexts. They are usually short, walkable segments of arterial or collector streets, often only a few blocks in length. They are within a grid or interconnected system of local streets serving the commercial center of town with short blocks, minimal or no driveways and buildings often served by alleys.

Land uses on main streets consist of compact, mixed-use development, usually with a strong retail and entertainment emphasis on the ground floors and an equal mix of residential and/or commercial office or services on the upper floors. The buildings are low-scale (generally one to three stories) and are oriented

to the street without setback. Also, they are closely spaced as shown in **Figure 6.1**. Parking lots or garages are located behind or to the side of buildings. Public parking consists of on-street parking and may include strategically located parking lots or garages that support a “park once” environment.

The design of main streets includes wide streetsides that support active uses such as street cafes, social interactions, strolling and window shopping (**Figure 6.2**). Main streets, by tradition and design, are pedestrian friendly and may have historic or contemporary urban design features, public spaces, or public art. Main streets typically are no wider than two travel lanes, provide on-street parking and may contain bicycle lanes. Transit consists of local service.

The key ingredients for a successful main street include:

- The architecture of the adjacent buildings, urban design features, the appearance of the street frontage and the provision of public spaces;
- The types and mix of uses, particularly those that generate pedestrian activity and create an active day and evening place;
- Street design that accommodates low-speed traffic, pedestrians, bicyclists and transit;
- Physical and visual thoroughfare and urban design elements that draw together both sides of the street and encourage frequent traversal of the street; and



Figure 6.3 The width of the streetside should be planned to accommodate the activities generated by the adjacent land uses. Source: Kimley-Horn and Associates, Inc.

- A public parking strategy that encourages walking.

According to a report prepared for the New Jersey Department of Transportation (*Scoring Formula for New Jersey's Main Streets*, Rutgers University, March 2003) and based on a visual preference survey, the attributes of a main street that positively affect how people view the street include:

- The proportion of street frontage with active commercial uses;
- A low proportion of street frontage with dead space such as vacant lots, parking lots and blank walls;
- The proportion of the street frontage with parked cars generating activity, providing a buffer between traffic and the streetside and slowing traffic;
- The proportion of the street with a tree canopy;
- Width of sidewalk, with wider facilities providing more public space and greater levels of activity (see **Figure 6.3**); and
- Visible curb extensions that provide for shorter crossing distances and space for plantings, street furniture and traffic calming.

Attributes of a main street that negatively affect how people view the street include:

- A high proportion of street frontage with dead space such as vacant lots, parking lots and blank

walls (a negative response is associated with more blank walls); and

- The number of travel lanes, where streets with more than two lanes are perceived as having higher speeds, more traffic, longer crossing distances and a less attractive appearance.

Design Factors That Create Main Street Thoroughfares

The multidisciplinary design team needs to consider a number of factors to create an appropriate main street environment. This process often requires trade-offs, such as balancing traffic throughput with economic development goals.

Traveled Way

In designing the traveled way, there are three important factors to consider: speed, width and parking. Because of the pedestrian-oriented nature of main streets, the target speed should be kept low (25–30 miles per hour) in main street segments, even on thoroughfares designated as principal arterials. This speed not only improves the user's perception of the street but also creates a safer environment, accommodates frequent parking maneuvers and is consistent with restricted sight distances encountered in urban places. The visual interest drivers experience on main streets requires lower speeds.

The width of the traveled way affects users' perceptions of the speed and volume of the street. Wide streets may be perceived as a barrier to crossing where frequent crossings are desired and encouraged. Typically, main streets are two lanes wide with parallel parking on both sides, resulting in a traveled way width of 36 to 38 feet (**Figure 6.4**) or 44 to 48 feet on streets with bicycle lanes. Wider streets may be required to accommodate angled parking (see discussion on implementing angled parking below). An increased number of travel lanes to three or four may be appropriate based on community objectives, the main street's role in the network, and the existence or lack of parallel thoroughfares.

On-street parking is considered an important design element on main streets. It provides a source of short-term parking for adjacent retail and service uses, buf-



Figure 6.4 A typical configuration of a main street traveled way. Source: Reid Ewing and Michael King.

fers pedestrians from traffic, creates friction that slows traffic and produces a higher level of street activity. Parallel parking lane width should be 8 feet to accommodate the high level of parking turnover experienced on main streets.

Main streets, as avenue or street thoroughfare types, should forego raised medians, as they create a physical and visual separation of the two sides of the street in an environment in which pedestrians are encouraged to cross the street frequently. Main streets, as boulevards or any thoroughfare wider than 60 feet, may use medians for pedestrian refuge or turn lanes. Landscaping and urban design elements within the median may be used to provide a unifying theme connecting both sides of the street. Landscaping is an important element of main streets. It serves as an amenity to pedestrians and helps provides a uniform theme, often as part of a planned streetscape. Landscaping on main streets should be designed and maintained so that it enhances the visibility and attraction of storefronts, signs and lighting. On new and redeveloping main streets, the design of building facades and signage should anticipate mature landscaping and accommodate its growth without interfering with visibility.

Common design issues related to main street traveled ways include:

- **Excessive street width:** Whether two- or four-lane cross-sections, excessively wide main streets create barriers to pedestrian crossings,

reduce the street enclosure created by the ratio of street width to building height and encourage high travel speeds. The practitioner may consider the following design solutions after assessing the traffic operations and other needs served by the street:

- Convert four-lane undivided sections to a three-lane section (one travel lane in each direction and a center turn lane or median with left-turn lanes at intersections). Use the width gained to add on-street parking, bike lanes, or, in the case of street reconstruction, wider sidewalks.
- A five-lane section on streets designated as collectors may be converted to a three-lane section with the remaining width used to provide angled parking on one or both sides of the street, depending on the total width of the street.
- Wide two-lane sections may be visually narrowed with the addition of a painted center turn lane (or raised median on boulevards), bike lanes, striping parking lane lines, or edge lines. Raised and landscaped curb extensions within parking lanes and at intersections can physically narrow the street.
- On avenue and street thoroughfares, relatively short (20 to 30 feet in length) raised and landscaped medians can be used to break up the width of the street, provide neck-down areas (especially when combined with curb



Figure 6.5 Angled parking is used to maximize on-street parking on main streets. On narrow streets, some communities use angled parking on one side and parallel parking on the other, and alternate the arrangement from block to block. Source: Kimley-Horn and Associates, Inc.

extensions) and can be used as pedestrian refuges when used in conjunction with mid-block crossings.

- On very wide thoroughfares (exceeding 90 feet curb to curb) or on very wide main streets where traffic throughput needs to be retained, consider implementing a multiway boulevard, potentially on only one side of the street.
- **Implementing angled parking:** Angled parking is one strategy to maximize the public parking supply on main streets, particularly in areas where off-street parking is limited. On low-volume, low-speed collector avenues and streets in commercial main street areas, where sufficient curb-to-curb width is available, angled parking may be appropriate. Angled parking can be implemented on both sides of the street or on one side of the street, with parallel parking on the other side (see **Figure 6.5**). On some main streets, angled and parallel parking are alternated in each block.

Angled parking can create sight distance problems associated with cars backing out of parking spaces. The use of reverse (back-in) angled parking in some cities has overcome these sight distance concerns and is considered safer for bicyclists traveling adjacent to angled parking. Angled parking requires a wider adjacent travel

lane than parallel parking to allow vehicles to back out (or back in) without encroaching onto the opposing travel lane. Because the depth of the angled parking spaces themselves and wider adjacent lanes increase the overall width of the street, the practitioner needs to assess the trade-offs between the addition of parking spaces and the negative effects associated with wider streets.

- **Main street is a state highway:** Many main streets are state highways, especially in smaller towns where rural highways or principal arterials pass through the community's historical commercial district. The design, maintenance and operation of these streets are controlled by the state department of transportation (DOT) and are subject to the state's policies and design standards. During redevelopment projects or during the planning of improvements to state highways, the community may desire features that conflict with state standards. While many DOTs recognize the value the community places on their main streets and are amenable to applying flexibility in the application of their standards using the "design exception" process, some desired design features may not be acceptable to the DOT, even if the local municipality regularly includes these features on its streets. DOTs typically will work with municipalities and the community to find solutions. The key elements to successful planning and implementation of walkable main streets on state highways include:
 - Involving the DOT in the earliest stages of planning and redevelopment projects located adjacent to a state highway;
 - Including the DOT as a key stakeholder in all stages of the project but especially when proposing any change or streetscape design to a state highway or connecting street;
 - Working collaboratively with the DOT and all other stakeholders to define a vision, goals and objectives and to identify a purpose and need statement for the project;
 - Identifying potential tensions early in the process and resolving them so they don't hold up the project in its last stages of planning and design;

- Understanding the DOT’s project development and design exception process, as these are the mechanisms through which any non-standard feature will be accepted;
- Discussing design flexibility with the state’s design engineers and establishing the ranges of acceptability prior to developing street designs; and
- Developing an early consensus on the concept plan and nonstandard design features. Build this consensus with a small subset of the ultimate stakeholders before going to the public and decision makers; this avoids establishing public and stakeholder expectations that will not be supported by the DOT, thus also avoiding dissatisfaction with the final concept plan.

Streetside

Streetside design features include an appropriate width to accommodate anticipated levels and types of activity. The provision of distinct streetside zones is very important on main streets. The clear pedestrian thoroughway should be wide enough, at a minimum, to allow two people to walk side-by-side. The frontage zone should allow for window shopping, seating, displays and pedestrian activity at building entrances.

The furnishings zone needs to accommodate many functions, including street trees, planting strips, street furniture, utilities, bicycle racks, transit facilities and public art. If community objectives desire, and regulations encourage restaurants, then ensure the streetside furnishings zone can accommodate potential street cafes.

The edge zone will need to accommodate frequent car door openings, parking meters and signing. Lighting in the streetside should provide both safety illumination of the traveled way and intersections and also pedestrian-scaled decorative light standards illuminating the pedestrian way.

Requirements for Great Streets

Great Streets author Allan B. Jacobs describes the physical qualities that are required to make great streets. He states that most of the qualities are directly related to social and economic criteria and designable qualities for creating good cities; accessibility, bringing people together, publicness, livability, safety, comfort, participation, and responsibility.

Some of these qualities may be challenging for the thoroughfare designers to quantify in the design, or are outside of the designer’s responsibility, thus underscoring the importance of multidisciplinary teams, stakeholder involvement and understanding the community’s vision. Jacobs’ requirements for great streets include:

- Places for people to walk with some leisure
- Physical comfort
- Definition of the street’s edge
- Qualities that engage the eyes without being disorienting
- Complementary building height and appearance
- Maintenance
- Quality of construction and design

For further information on these qualities, refer to Part Four of *Great Streets*.

Intersections

Main street intersection design should emphasize slow speeds and the management of conflicts through appropriate traffic control and improved visibility. Intersections on main streets should emphasize pedestrian convenience, as these types of streets encourage frequent crossing. Main street intersections should be as compact as possible with short crossing distances, using curb extensions where possible. Curb-return radii should be minimized and based on the design and control vehicles selected (see Chapter 7). Crosswalks need to be allowed on all approaches of the intersection. Midblock crossings are usually not necessary due to short block lengths but may be considered where

blocks are unusually long and there is a demonstrated demand to cross. Typical main street intersections would include the following design elements:

- Crosswalks on all approaches of signalized and unsignalized intersections using highly visible markings (e.g., longitudinal crosswalks) or alternative paving material;
- Curb extensions on streets with on-street parking;
- Curb-return radius as small as practicable on streets without on-street parking or where design/control vehicle warrants a larger radius;
- Channelized right-turn lanes are generally inappropriate for main street environments but—where needed due to intersection angle or required design vehicle—design should be low speed, with adequate-sized island for pedestrian refuge and possible signal control in high pedestrian-volume locations;
- Pedestrian countdown timers at signalized intersections; indications should not require button activation;
- Short cycle lengths to reduce pedestrian waiting time, and pedestrian clearance intervals set for slower-walking pedestrians; and
- Wheelchair-accessible curb ramps and audible indicators conforming to Public Rights-of-Way Accessibility Guidelines (PROWAG).

A more detailed discussion of the intersection design elements listed above are presented in Chapter 10.

Main Street Design Parameters

Table 6.5 provides general design parameters for commercial avenues and streets in context zones C-3 through C-5 that may be applicable in the design of main streets.

Multiway Boulevards

The multiway boulevard is an alternative to conventional higher-volume, higher-speed arterial streets. This thoroughfare type may be used where the community's objective is to accommodate urban mixed use or residential development and a walkable environment on corridors with high traffic demands. A multiway boulevard combines a central thoroughfare

for higher-speed through movements bordered by landscaped medians that separate the central thoroughfare from one-way access lanes on each side of the boulevard. The access lanes provide for slower local traffic, parking, bicycle travel and a pedestrian-oriented streetside and are designed to discourage through traffic. Multiway boulevards may be considered where a community desires to make a very wide arterial street more pedestrian friendly yet recognizes the need to retain traffic capacity.

Characteristics of Multiway Boulevards

The general configuration of a multiway boulevard is a bidirectional central roadway that contains four or more lanes and may be divided or undivided, with one-way access lanes on both sides separated from the central roadway with medians. Characteristics of the central roadway and access lanes include:

- Central roadway—emphasizes through traffic movement and therefore should minimize impediments to this function. This includes access control between intersections, simplified phasing at signalized intersections and restricted movements onto and from the central roadway. The central roadway may contain a raised landscaped median separating the two directions of travel (in addition to the medians separating the central roadway from the access lanes), depending on right of way and landscaping desires. Parking is generally prohibited on the central roadway. For purposes of this report, the central roadway's target speed would be 35 miles per hour (mph) or less. The design and operation of cross-street intersections is addressed below.
- Access lanes—emphasize local interface with adjacent land uses. The access lanes are narrow, one-lane, very low-speed one-way streets that include on-street parking and potentially a shared vehicle/bicycle lane. Through traffic on access lanes is discouraged through design. Bike lanes may be provided, but it is preferred that bikes share the vehicular lane.² The design and operation of cross-street intersections is addressed below. Access lanes preferably should not provide driveway access to adjacent properties.

² Designers are encouraged to consult the MUTCD for the current signing and marking for this configuration. Traffic control device applications of this type are evolving.

Table 6.5 Main Street Design Parameters

Context	Suburban (C-3)		General Urban (C-4)		Urban Center (C-5)	
	Commercial Main Streets					
	Avenue	Street	Avenue	Street	Avenue	Street
Building Orientation (entrance location)	front, side	front, side	front	front	front	front
Maximum Building Setback	5 ft.	5 ft.	0 ft.	0 ft.	0 ft.	0 ft.
Off-Street Parking Access/Location	rear, side	rear, side	rear, side	rear, side	rear, side	rear, side
Streetside						
Recommended Streetside Width	15 ft.	14 ft.	16 ft.	14 ft.	19.5 ft.	16 ft.
Edge Zone	1.5 ft. minimum for operational clearance. Use 2.5 ft. if angled parking is considered. Ensure edge zone is wide enough to accommodate parking meters, utilities and signs.					
Furnishings Zone Width	6 ft. tree well	6 ft. tree well	6 ft. tree well	6 ft. tree well	6 ft. tree well	6 ft. tree well
	Wider furnishings zone is needed to provide public spaces and if main street uses include the potential for street cafes.					
Pedestrian Throughway (minimum)	6 ft.	6 ft.	6 ft.	6 ft.	9 ft.	6 ft.
Frontage Zone	2.5 ft. to 3 ft. minimum to accommodate commercial activity along building fronts. Wider frontage zone is needed (6 ft. or wider) if potential for street cafes or merchandise displays.					
Street Lighting	Intersection safety lighting, basic street lighting and pedestrian-scaled lighting.					
Traveled Way						
Target Speed (mph)	25	20–25	25	20–25	25	20–25
Number of Through Lanes	2–4	2	2–4	2	2–4	2
Lane Width	10–12 ft.	10–12 ft.	10–12 ft.	10–12 ft.	10–11 ft.	10–11 ft.
Parallel On-Street Parking Width	8 ft.	8 ft.	8 ft.	8 ft.	8 ft.	8 ft.
Min. Combined Parking/Bike Lane Width	13 ft.	13 ft.	13 ft.	13 ft.	13 ft.	13 ft.
Medians	Optional	None	Optional	None	Optional	None
Bike Lanes (minimum/preferred width)	5 ft./6 ft.	5 ft./6 ft.	5 ft./6 ft.	5 ft./6 ft.	5 ft./6 ft.	5 ft./6 ft.
Access Management	Minimize driveways on main streets. Access land uses via cross streets and/or alleys.					
Typical Traffic Volume Range (vehicles per day)	5,000–20,000+	1,000–15,000	5,000–20,000+	1,000–15,000	5,000–20,000+	1,000–15,000
Intersections						
Curb Extensions (with on-street parking)	Yes	Yes	Yes	Yes	Yes	Yes
Minimum Curb Return Radii (if extensions not used)	10–15 ft.	10–15 ft.	10–15 ft.	10–15 ft.	10–15 ft.	10–15 ft.
Roundabouts	Not recommended on main streets, except as gateway intersections					

Property should be accessed from cross-streets or alleys, although access lanes may be intersected by local streets or consolidated driveways without direct access to the central roadway. Access lanes provide on-street parking that may be associated with curb extensions at intersections or extensions that contain street trees. The width of access lanes is composed of the parking lane (7 to 8 feet) and a shared travel lane (10 to 11 feet). Some fire departments may require wider access lanes. However, for emergency access purposes, buildings may be able to be accessed from the central roadway. The maximum width of an access lane should be 17 feet with parking on one side and 24 feet with parking on both sides.

- Median islands—raised medians are used to separate the access lanes from the central roadway. The width of these medians varies because they may serve multiple functions. At a minimum, the median contains landscaping, including trees, streetlights, traffic signs and other utilities. On transit streets, the medians accommodate bus stops or stations. On multiway boulevards with very wide medians, sidewalks, seating and other urban design features may be provided. Medians may be designed with mountable curbs and load-bearing surfaces on the access lane side to accommodate

emergency vehicles. Median breaks are provided on some traditional multiway boulevards to allow vehicles into the access lane and entry back into the central roadway where turn movements are restricted at the intersections.

- Streetside—provides a highly pedestrian-oriented environment and access to building entrances. On residential boulevards, the streetside emphasizes planting strips or tree wells and pedestrian-scaled lighting. On commercial boulevards, the streetside is designed to accommodate the activities of the adjacent ground floor uses, emphasizing wide furnishing zones for street trees, seating, urban design features and street cafes. See Chapter 8 for details on the streetside.

General Cross-Section Design Parameters and Right-of-Way Requirements

Because of their multiple components, the multiway boulevard typically has greater right-of-way requirements than other types of boulevards. Although streetside and median widths can vary substantially, the minimum right of way for a basic four-lane multiway boulevard is 104 feet, composed of the following elements (see **Figure 6.6**):

- 9-foot-wide streetsides;

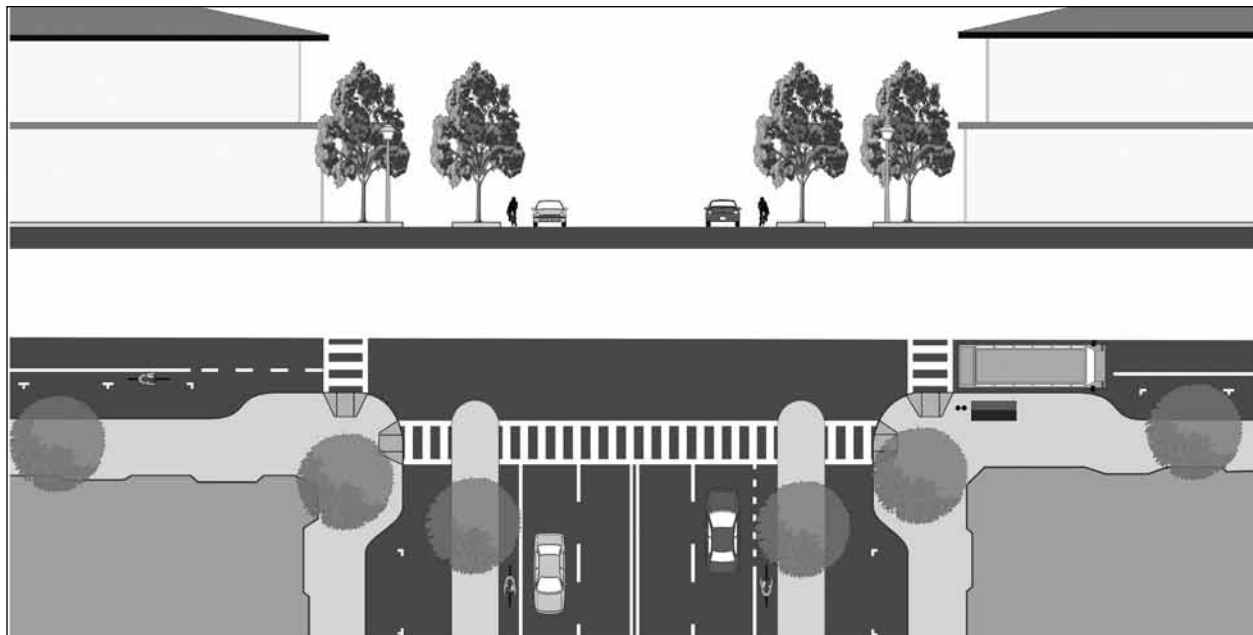

Figure 6.6 A multiway boulevard is characterized by a central roadway with a pair of one-way access lanes. This type of thoroughfare can combine high vehicular capacity with pedestrian-friendly streetsides. Source: Digital Media Productions.

- 7-foot parking lanes;
- 10-foot access lanes;
- 6- to 10-foot medians (allows for street trees and utilities); and
- Four 10- to 11-foot central roadway travel lanes.

As an example of a more desirable multiway boulevard width in an urban center (C-5) commercial context, the recommended right of way of a four-lane multiway boulevard, based on the design parameters presented in **Table 6.4** and Chapters 8 and 9, would be 149 feet composed of

- 21.5-foot streetsides;
- 7-foot parking lanes;
- 10-foot access lanes;
- 14-foot medians (space for canopy trees, street lighting, bus stops with seating/shelters and pedestrian refuge); and
- Four 11-foot central roadway travel lanes.

It may be desirable to provide a raised median within the central roadway to provide for access management, street lighting, trees, pedestrian refuge and left-turn lanes at intersections. The width of a median in the central roadway will vary depending on function (see Chapter 9 for recommended median widths), but would add 4 to 18 feet or more to the right-of-way requirements. Bicycle lanes may also be a part of the central roadway, which would require another 10 feet of right-of-way width.

The right of way of several existing two-way multiway boulevards in the United States ranges from 165 feet (The Esplanade in Chico, CA) to 210 feet (Ocean Parkway in Brooklyn, NY). The differences in width are related to the number of central roadway lanes (four versus six), existence of medians in the central roadway and width of access lanes and access lane medians (Bosselman, MacDonald, Kronmeyer. *Environmental Quality of Multiple Roadway Boulevards*, Institute of Urban and Regional Development, University of California at Berkeley, 1997). **Figure 6.7** is an example of a multiway boulevard that merges the access lane in advance of the intersection (see the next section on intersection design).



Figure 6.7 This multiway boulevard merges the access lane into the central roadway in advance of intersections. Source: Kimley-Horn and Associates, Inc.

Multiway Boulevard Intersection Design

Intersections on multiway boulevards provide one of the most challenging aspects of designing this type of thoroughfare. For successful multiway boulevard design, it is essential that all of the design elements work together to manage the various traffic flows safely.

The most frequent concern about multiway intersection design usually relates to how to control the side access lanes. However, if properly designed, the side access lanes will have low volumes, and potential conflicts will be minimal. Proper geometric design and signing are also needed to communicate which user has the right of way at any given time. The access lanes should not be used to carry vehicles going several blocks along the multiway boulevard. Narrow side access lanes and proper intersection control will discourage through use of the access lanes. Because of the proximity of the access lane to the central roadway, queuing on the cross-streets can block access lanes, and this will further discourage use of the access lanes as through routes. Traffic engineers may also be concerned with conflicts between vehicles turning right from the central roadway and vehicles entering the intersection from the access lane. This is best addressed by having tight corner radii for both the central roadway and the access lanes and good sight lines between the central roadway and the access lanes so the turning driver can avoid a conflict.

At this time there is no widely agreed-upon way to design and operate a multiway boulevard intersection. Multiway boulevards, both old and new, exist in many



Figure 6.8 This multiway boulevard provides stop control for the low-volume, low-speed access lanes. The central roadway is controlled by a traffic signal. Source: Kimley-Horn and Associates, Inc.

places in Europe and the United States, and the challenges of the intersections have been addressed in many ways. The traditional design of multiway boulevard intersections is to provide stop control for the access lanes and signalized or stop control for the cross-streets and central roadway (see **Figure 6.8**). In urban areas, the access lanes are often controlled with traffic signals and sometimes restrict selected movements from both the central roadway and the access lanes. Common traffic control and operational configurations for traditional multiway boulevard intersections are described in **Table 6.6** and illustrated in **Figure 6.9**.

Alternative Multiway Intersection Designs

Thoroughfare designers have developed a number of alternatives to the traditional multiway boulevard intersection. These alternatives include:

- Access road slip ramps prior to and after intersections to provide conventional four-leg intersections;
- Forced right turns from the access lane to the cross-street. Where turning movements are restricted, cross-streets should be part of a well-connected grid of streets so vehicles leaving the access lanes can easily return to the central roadway;
- Access lanes diverted away from the central roadway at cross streets increase separation and reduce the complexity of the intersection. This

design concept significantly affects the placement of buildings at intersection corners; and

- Access lanes beginning just past an intersection (either with or without a lane drop), and ending with or without a lane addition just before an adjacent intersection, similar to the design of frontage roads.

All of the above alternatives disrupt the continuity of the access lane along the length of the boulevard. This is an important factor in considering local circulation, particularly if the access lanes provide for bicycle travel along the corridor.

Design Examples

The following design examples provide a brief synopsis of the design process, illustrating some of the key steps in developing and evaluating solutions to thoroughfare design problems. The examples do not represent all of the possible combinations but do show some common thoroughfare situations. The four examples respectively illustrate the following thoroughfare design scenarios:

1. Creation of a retail-oriented and pedestrian-friendly main street collector avenue;

Table 6.6 Traffic Control and Operation Configurations for Multiway Boulevard Intersections

Type of Approach Control (Refer to Fig. 6.9)		Special Treatments or Movement Restrictions	Conditions for Application
A	Two-Way Stop Intersection <ul style="list-style-type: none"> • Central roadway uncontrolled • Cross-street stop controlled • Access lane stop controlled 	<ul style="list-style-type: none"> • No restricted movements, or • Access lane restricted to through-right turn only 	<ul style="list-style-type: none"> • Low-volume cross-street traffic • Moderate-volume central roadway traffic • Residential or low-intensity mixed use and commercial areas
B	All-Way Stop Intersection <ul style="list-style-type: none"> • Central roadway stop controlled • Cross-street stop controlled • Access lane stop controlled 	<ul style="list-style-type: none"> • No restricted movements, or • Access lane restricted to through-right turn only 	<ul style="list-style-type: none"> • Low cross-street traffic volume • Low to moderate central roadway traffic volume • Residential or low-intensity mixed use and commercial area
C	Two-Phase Signalized Intersection <ul style="list-style-type: none"> • Central roadway signalized • Cross-street signalized • Access lane stop controlled 	<ul style="list-style-type: none"> • Access lane through and right turns may proceed with central roadway through movement after stop • Central roadway right turns may be prohibited 	<ul style="list-style-type: none"> • Low to moderate cross-street traffic volume • Low to moderate central roadway traffic volume • Residential or low-intensity mixed use and commercial area
D	Multi-Phase Signalized Intersection #1 <ul style="list-style-type: none"> • Central roadway signalized • Cross-street signalized • Access lane signalized 	<ul style="list-style-type: none"> • Central roadway may have protected left-turn phasing • Access lanes restricted to through and right-turn only • Access lane proceeds during central roadway through movement • Cross-street has permissive turn phasing • Central roadway right-turns prohibited 	<ul style="list-style-type: none"> • Moderate to high cross-street traffic volume • Moderate to high central roadway traffic volume • High-intensity mixed use and commercial area
E	Multi-Phase Signalized Intersection #2 <ul style="list-style-type: none"> • Central roadway signalized • Cross-street signalized • Access lane signalized 	<ul style="list-style-type: none"> • Central roadway may have protected left-turn phasing • Cross-street has permissive turn phasing • Access lanes have split phasing, allowing all movements 	<ul style="list-style-type: none"> • Moderate to high cross-street traffic volume • Moderate to high central roadway traffic volume with high volume of left turns • High-intensity mixed use and commercial area
F	Multi-Phase Signalized Intersection #3 <ul style="list-style-type: none"> • Central roadway signalized • Cross-street signalized • Access lane stop controlled 	<ul style="list-style-type: none"> • Access lane right turns only may proceed after stop • Central roadway has permissive turn phasing • Cross-street has permissive turn phasing, and may use split phasing 	<ul style="list-style-type: none"> • Low to moderate cross-street traffic volume • Low to moderate central roadway traffic volume • Residential or low-intensity mixed use and commercial area

2. Transformation of an obsolete suburban arterial to a boulevard in a mixed use area;
3. Design of a high-capacity arterial boulevard in a newly urbanizing area; and
4. Four- to three-lane arterial avenue conversion in a central business district.

The design process used in the examples follows the design stages introduced and described in Chapter 5. The design examples provide a general overview of the process to illustrate the five stages of design.

The details of the evaluation and development of the actual design are omitted in the four examples.

Remember Network Potential

In all cases of designing walkable urban thoroughfares, part of the analysis will be to analyze network capabilities, contexts and travel patterns to determine whether and how much the network can accommodate some of the study thoroughfare's existing or projected traffic. This may require operational or physical improvements. However, it may lead to a more contextually desirable improvement and more effective overall solution.

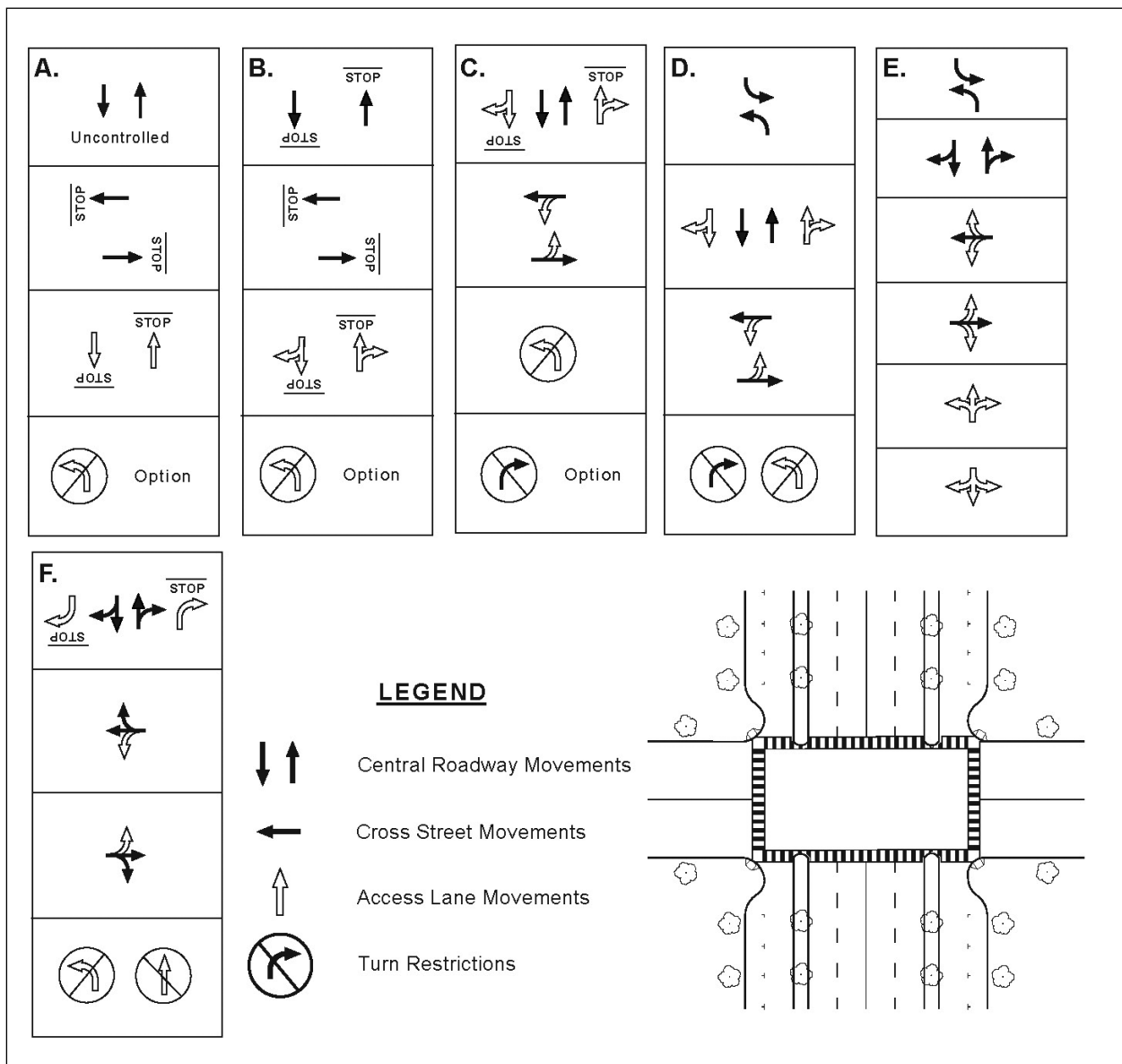

Figure 6.9 Various traffic control and turn restriction options can be employed at multiway boulevard intersections. See **Table 6.6**. Source: Kimley-Horn and Associates, Inc.

Design Example #1: Creating a Retail-Oriented Main Street

Objective

Convert an existing four-lane minor collector street into a commercial-oriented street that supports an adjacent mix of retail, restaurants and entertainment uses on the ground floor.

Stage 1: Review or develop an area transportation plan

Review the area transportation plan to determine how the subject thoroughfare relates to the overall network, types of modes served, functional classification, existing and future operational characteristics and so forth. Collect existing and projected data as necessary.

Existing Street Characteristics

Existing street is a four-lane, undivided collector street with the following characteristics (see **Figures 6.10** and **6.11**).

- Functional classification: minor collector.
- Right of way: 60 feet.
- Four through-traffic lanes plus 6-foot sidewalks on each side.
- On-street parking: none.
- Average daily traffic (ADT): 10,000–13,000 vehicles per day (vpd).
- Speed limit: 35 mph.
- Percent heavy vehicles: 2–3 percent.
- Intersection spacing: 600–700 feet.
- Network pattern: grid.
- Center turn lane: none.
- Transit: low-frequency local route.
- Bicycle facilities: not a designated bike route.
- No landscaping.
- Conventional street and safety lighting.

Stage 2: Understand community vision for context and thoroughfare

Vision

An existing commercial street in a suburban (C-3) area undergoing change to an urban center (C-5). Emphasizes an active street life that is to be achieved through the mix and intensity of land uses, site and architectural design, with an emphasis on pedestrian facilities and on-street parking.

Stage 3: Identify compatible thoroughfare types and context zones

Existing context is identified by assessing the character and attributes of existing land uses such as building orientation to the street, building height, parking orientation, mix and density of uses and so forth. Future context is determined by interpreting the vision, goals and objectives for the area. Thoroughfare type is selected based on the urban thoroughfare characteristics (Table 4.2 in Chapter 4).

- Existing context zone: C-3.
- Future context zone: C-5.
- Desired thoroughfare type: avenue.

Stage 4: Develop and test the initial thoroughfare design

Desirable Design Elements (in prioritized order based on vision)

- Lower target speed.
- On-street parking.
- Wide sidewalks.
- Street furniture and landscaping including benches and space for cafes, public space and so forth.
- Pedestrian-scaled lighting.
- Street trees.
- Bus stops with shelters.
- Transitions between main street and adjacent higher-volume segments.

- Midblock crosswalks on long block sections.
- Bike accommodations.

Factors to Consider/Potential Trade-Offs

- Right-of-way constrained to 60 feet.
- Maximizing parking with angled versus parallel parking; changing to angled parking may increase accidents and delays.
- Reduction in the number of through lanes and vehicle capacity versus wider sidewalks and on-street parking.
- Accommodation of large vehicles versus narrowing lane width and smaller curb-return radii to reduce pedestrian crossings.
- Accommodation of bicyclists versus width of other design elements.

Possible Alternative Solutions (see Figure 6.12)

1. Emphasize vehicular capacity by retaining existing four-lane section with 10-foot-wide travel lanes to allow 10-foot-wide sidewalks.
2. Emphasize parking by providing angled parking on one side, parallel parking on the other side and narrowing the two remaining travel lanes.
3. Emphasize parking and wider sidewalks by providing parallel parking on both sides, two travel lanes and 12-foot-wide sidewalks.
4. Emphasize parking and vehicular capacity with parallel parking on both sides, 9-foot-wide sidewalks, two travel lanes and a center turn lane.

In all cases use grid network to divert some traffic from project thoroughfare so reduced number of traffic lanes will suffice. This may require operational or physical improvements to other streets. Traffic to be diverted will depend on travel patterns, context and design of other thoroughfares.

Compare benefits of the four alternatives. **Figure 6.13** demonstrates one way of showing such a comparison.

Selected Alternative

Alternative #3:

- Maximizes sidewalk width;

- Provides moderate to good level of on-street parking;
- Balances street width with accommodation of larger vehicles and speed reduction;
- Allows for left-turn lanes at intersections by restricting parking; and
- Provides 10-foot minimum travel lane width.

Stage 5: Develop detailed thoroughfare design

Figure 6.14 shows a rough schematic view of how the selected alternative might be designed.

Solution Design Features

Traveled Way:

- Target speed: 25 mph.
- Traffic signals synchronized to target speed.
- Two 10-foot travel lanes.
- Two 8-foot parallel parking lanes.

Streetside:

- 12-foot sidewalks.
- Pedestrian-scaled lighting.
- Street trees in tree wells.
- 6-foot furnishings and edge zone.
- 6-foot clear pedestrian throughway.
- No frontage zone.

Intersections:

- Curb extensions to reduce pedestrian crossing distance unless left-turn lane is provided.
- High-visibility crosswalk markings.
- Safety lighting.
- Far-side bus stops with curb extension and shelters.
- ADA compliance.

Parallel thoroughfares (as needed):

- Directional signing.
- Operational adjustments or improvements.
- Physical improvements.



Figure 6.10 View of existing street. Source: Kimley-Horn and Associates, Inc.

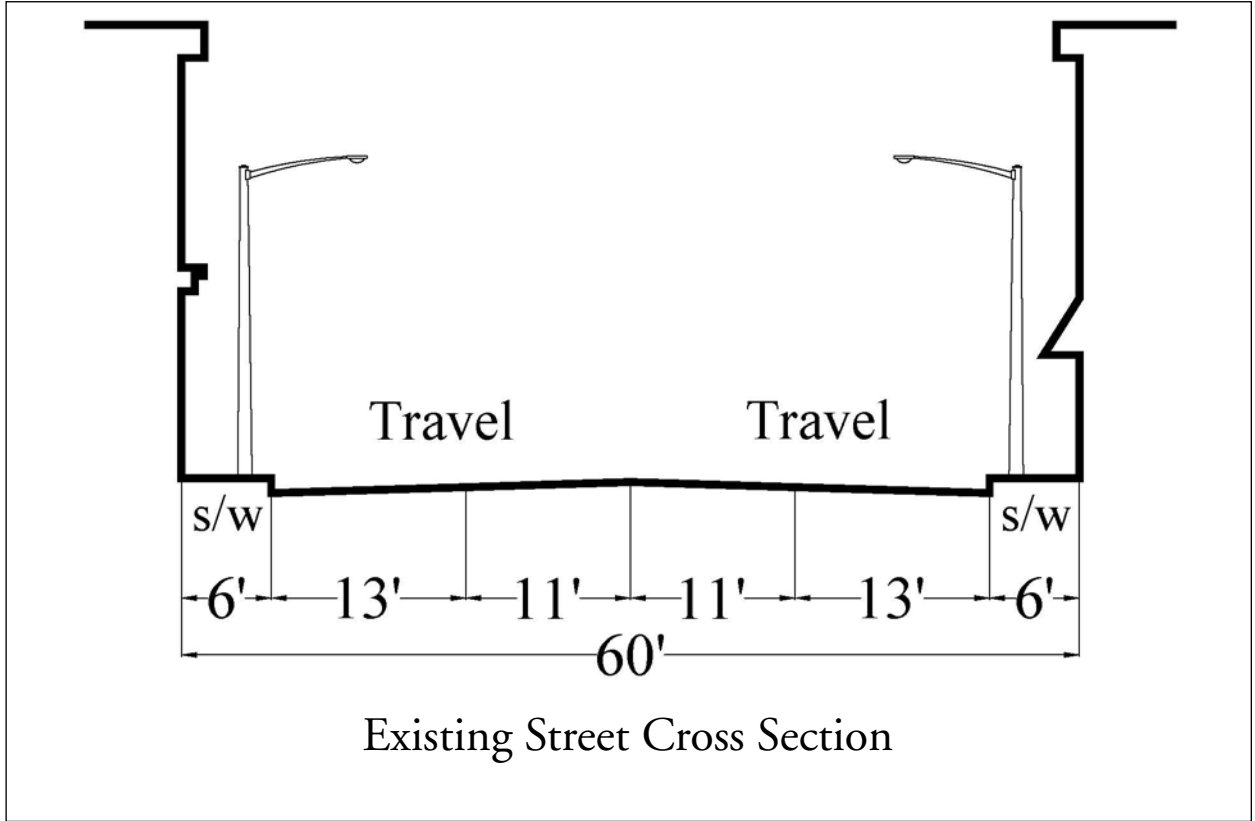

Figure 6.11 Existing street cross section. Source: Kimley-Horn and Associates, Inc.

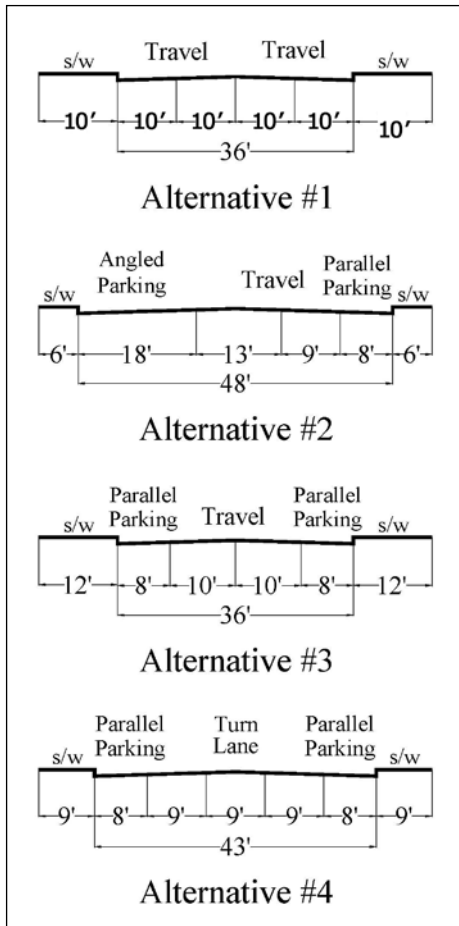

Figure 6.12 Alternative street cross sections. Source: Kimley-Horn and Associates, Inc.

Relative Comparison of Trade-Offs

Alternative	Parking	Sidewalk Width	Vehicular Capacity	Large Vehicle Accommodation	Pedestrian Crossing Width	Left Turn Lanes	Bike Accommodation	Ped. Amenity Accommodation	Speed Reduction
Existing	--	--	++	++	--	--	--	--	--
1	--	++	++	--	--	-	--	++	+
2	++	--	-	+	++	++	--	--	-
3	+	++	-	++	++	-	--	++	+
4	+	-	+	--	+	++	--	-	++

Score (relative to other alternatives)
 ++ Good (achieves objectives)
 + Fair
 - Poor
 -- Fails to meet/achieve objectives

Figure 6.13 Relative comparison of alternative trade-offs. Source: Kimley-Horn and Associates, Inc.

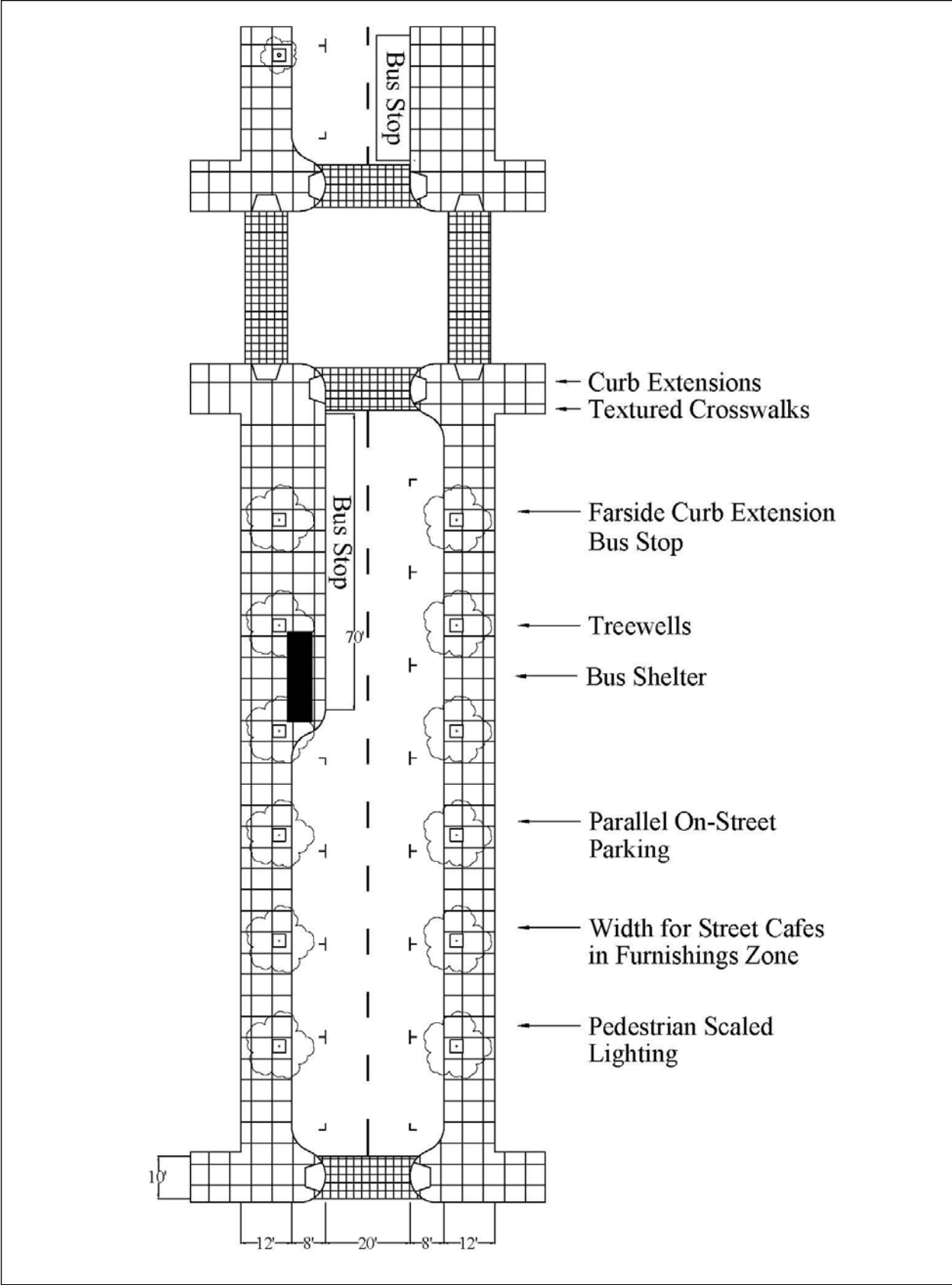

Figure 6.14 Schematic plan view of Alternative #3. Source: Kimley-Horn and Associates, Inc.

Design Example #2: Transforming a Suburban Arterial

Objective

Transform an obsolete suburban arterial into a boulevard serving a mixed-use commercial-oriented street in an area evolving from a typical suburban pattern (C-3) to a mixed environment with commercial activity and walkable development pattern (C-4).

Stage 1: Review or develop an area transportation plan

Existing Street Characteristics (see Figures 6.15 and 6.16)

Existing street is a seven-lane undivided arterial street with the following characteristics:

- Functional classification: principal arterial.
- Right of way: 100 feet.
- Six through-traffic lanes plus center turn lane.
- On-street parking: none.
- ADT: 32,000–40,000 vpd.
- Speed limit: 45 mph.
- Percent heavy vehicles: 4–5 percent.
- Intersection spacing: 1,250 feet.
- Network pattern: 1 mile arterial grid.
- Center turn lane: 14-foot two-way left-turn lane (TWLTL) with turn bays at intersections
- Transit: high-frequency regional route.
- Bicycle facilities: not a designated bicycle route.
- No sidewalks (4-foot, unpaved utility easement in right of way on both sides).
- No landscaping.
- Conventional street and safety lighting.

Stage 2: Understand community vision for context and thoroughfare

Vision

Community supports higher-intensity, higher-value development in an existing strip commercial corridor, transforming the suburban character of the corridor to general urban (C-4). Redesign of the street to create an attractive, walkable boulevard is a public-sector

investment strategy to stimulate change. The corridor is envisioned to support a diverse mix of pedestrian-oriented retail, office and entertainment.

Stage 3: Identify compatible thoroughfare types and context zones

- Existing context zone: C-3.
- Future context zone: C-4.
- Desired thoroughfare type: boulevard.

Stage 4: Develop and test the initial thoroughfare design

Desirable Design Elements (in prioritized order based on vision)

- Lower target speed (35 mph).
- Gradual speed transition from higher-speed segments to study segment.
- Landscaped median.
- Wide sidewalks.
- Street trees.
- Typical multimodal intersection design.
- Pedestrian facilities including benches and space for cafes, public spaces and so forth.
- Pedestrian-scaled lighting.
- Bus stops with shelters.
- On-street parking.
- Increased crossing opportunities using consolidated signalized driveways.

Factors to Consider/Potential Trade-Offs

- Reduction in the number of through lanes and vehicle capacity versus wider sidewalks and median.
- Accommodation of large vehicles versus narrowing lane width.
- Provision of on-street parking versus median and wider sidewalks.
- Right-of-way acquisition to accommodate desirable features.

- Need to gradually reduce speed on higher-speed segments approaching the lower-speed segment under design.

Alternative solutions (see **Figure 6.17**)

1. Provide parking, median and minimum-width sidewalks by reducing to four travel lanes.
2. Provide wide landscaped median and sidewalks by reducing to four travel lanes without providing on-street parking.
3. Provide all desirable features, including median, wide sidewalks and parking, by reducing to four travel lanes and acquiring right of way or require private development to dedicate 7 feet.
4. Emphasize vehicular capacity and provide median and sidewalks by retaining six narrower travel lanes without providing on-street parking. Alternatively, the 11-foot outside lanes could be used for curb parking during off-peak periods and converted to travel lanes during the peak. This alternative would not provide curb extensions at intersections.

In all cases use grid network to divert some traffic from project thoroughfare so a reduced number of traffic lanes will suffice. This may require operational or physical improvements to other streets. Traffic to be diverted will depend on travel patterns, context and design of other thoroughfares.

Compare benefits of the four alternatives. **Figure 6.18** demonstrates one way of showing such a comparison.

Selected Alternative

Alternative #1:

- Near-term: Provides all desirable design features, except that it results in narrower sidewalks than other alternatives.
- Long-term: As corridor redevelops, right of way can be acquired or development can be required to provide an easement to widen sidewalks further.
- Selected alternative provides a balance between competing needs and provides most of the desirable design features without requiring right-of-way acquisition.

Stage 5: Develop detailed thoroughfare design

Figure 6.19 shows a schematic view of how the selected alternative might be designed.

Solution Design Features

Traveled Way:

- Target speed: 35 mph.
- Four 11-foot travel lanes.
- Two 8-foot parallel parking lanes.
- Tree planters in parking lane to increase planting opportunity.
- Signalized intersection spacing at 400 feet at consolidated driveways or midblock pedestrian signals to create crossing opportunities.

Streetside:

- 12-foot sidewalks.
- Pedestrian-scaled lighting.
- Street trees in tree wells.
- 6-foot furnishings zone and edge zone.
- 6-foot clear pedestrian throughway.
- Throughway and frontage zone ultimately expanded with redevelopment.

Intersections:

- Curb extensions to reduce pedestrian crossing distance.
- High-visibility crosswalks.
- Safety lighting.
- Far-side bus stops within parking lanes.

Parallel thoroughfares (as needed):

- Directional signing.
- Operational adjustments or improvements.
- Physical improvements.



Figure 6.15 View of existing street. Source: Kimley-Horn and Associates, Inc.

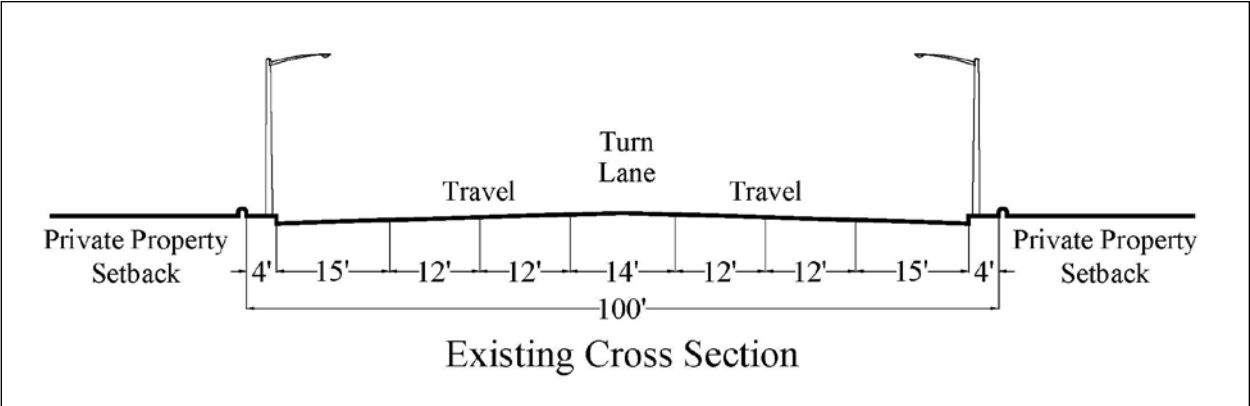

Figure 6.16 Existing cross section. Source: Kimley-Horn and Associates, Inc.

Figure 6.17 Alternative street cross-sections. Source: Kimley-Horn and Associates, Inc.

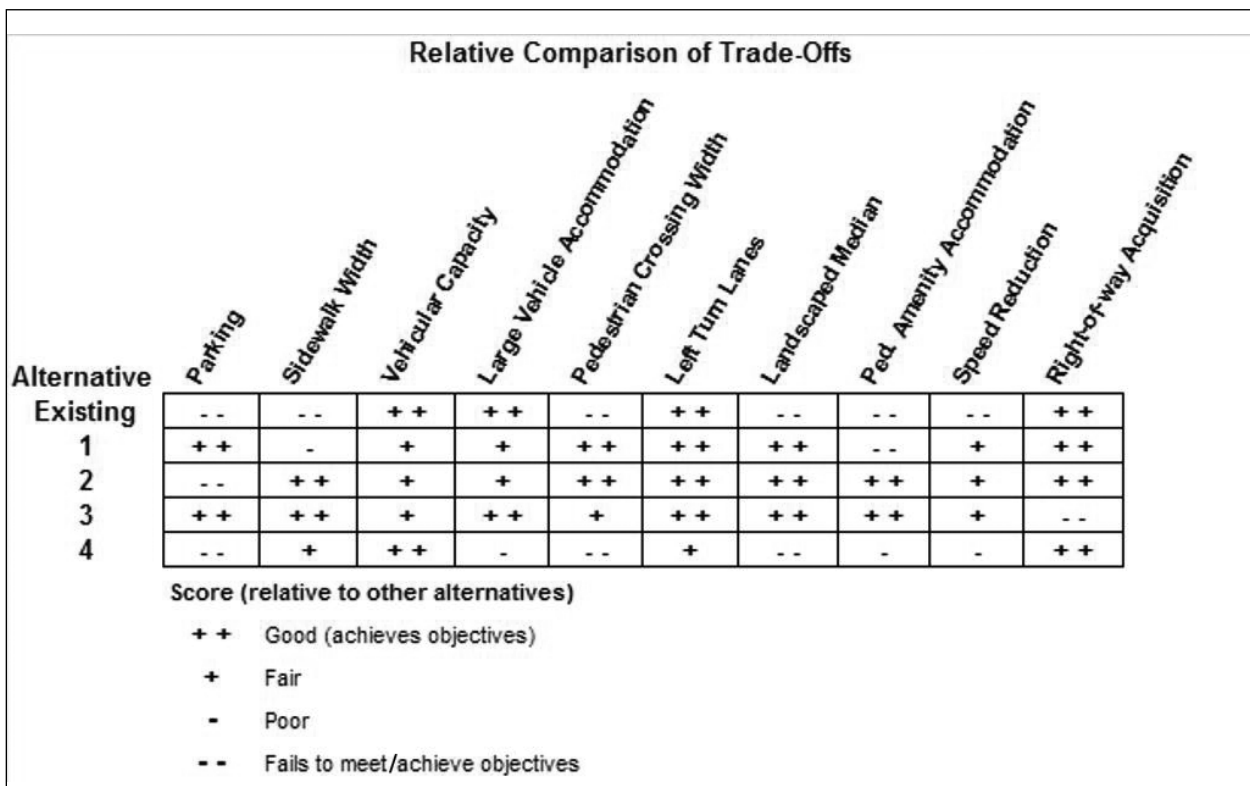
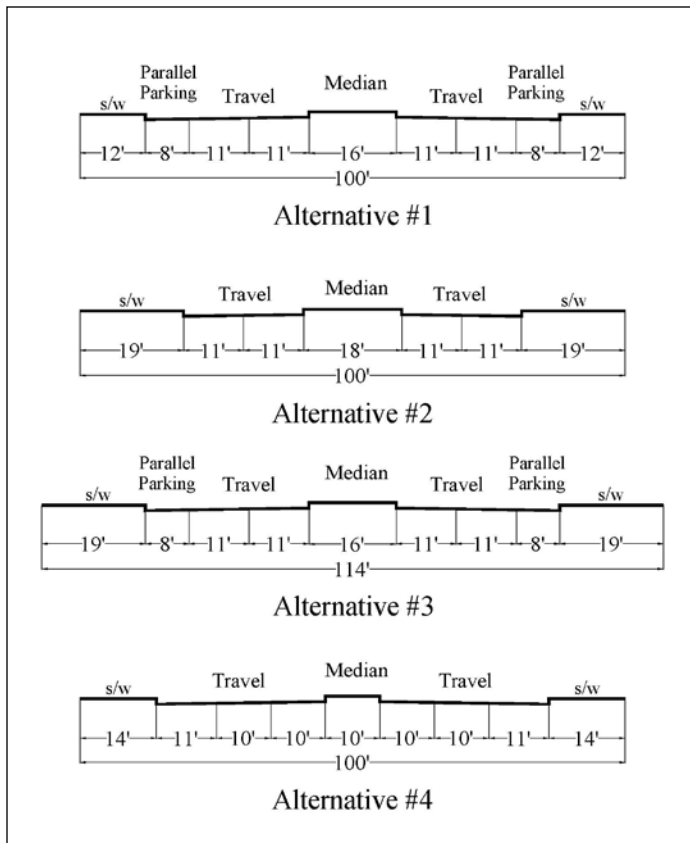

Figure 6.18 Relative comparison of alternative trade-offs. Source: Kimley-Horn and Associates, Inc.

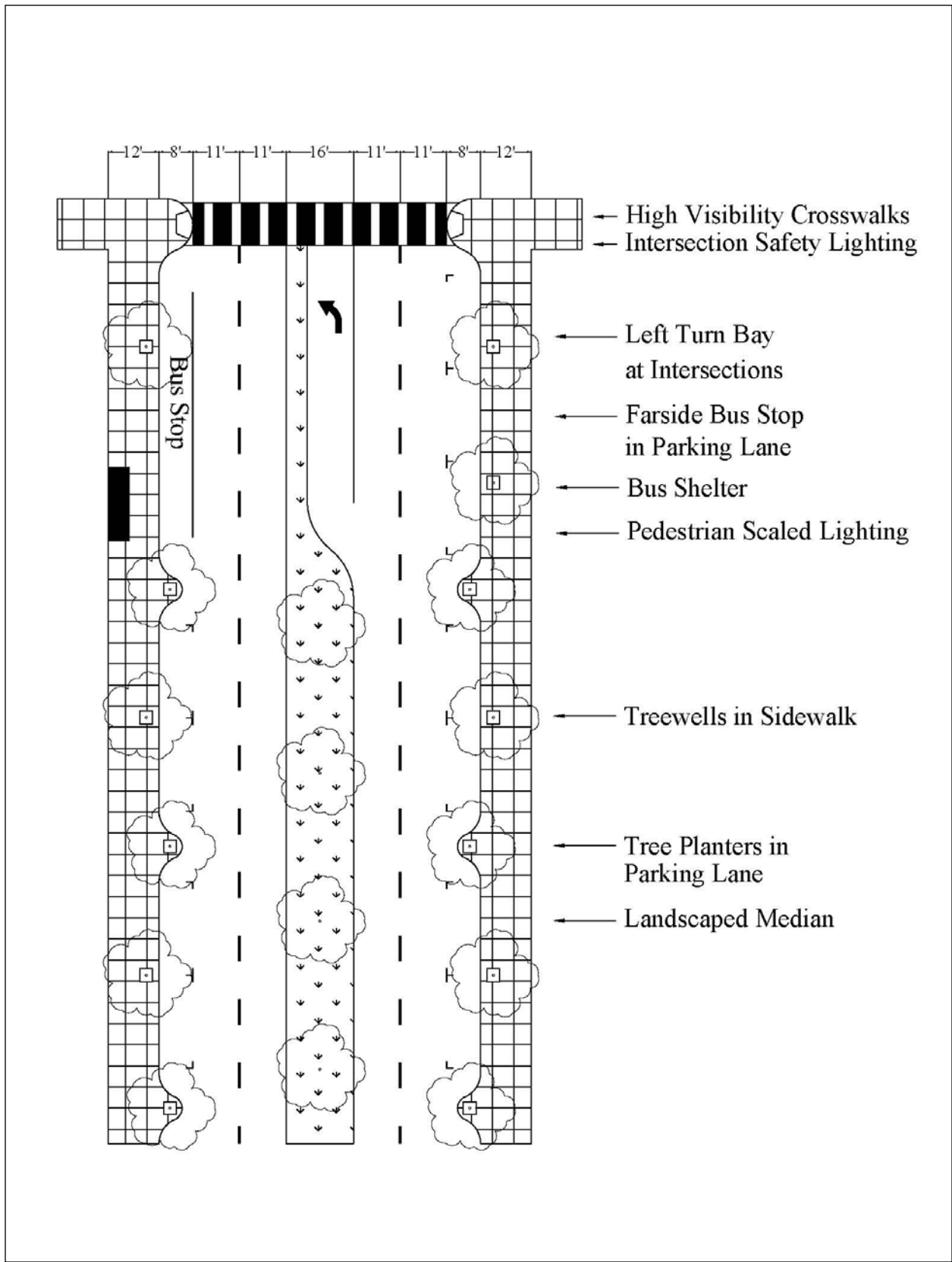

Figure 6.19 Schematic plan view of Alternative #3. Source: Kimley-Horn and Associates, Inc.

Design Example #3: High-Capacity Thoroughfare in Urbanizing Area

Objective

Design a thoroughfare in a newly urbanized area that accommodates high levels of traffic and buffers adjacent land uses from traffic impacts.

Stage 1: Review or develop an area transportation plan

Existing Street Characteristics (see Figures 6.20 and 6.21)

Existing street is a five-lane undivided arterial street with the following characteristics:

- Functional classification: minor arterial.
- Right of way: 90 feet.
- Four through-traffic lanes plus center turn-lane, median.
- On-street parking: none.
- Existing ADT: 25,000–30,000 vpd.
- Projected ADT: 45,000 vpd.
- Speed limit: 40 mph.
- Percent heavy vehicles: 4–5 percent.
- Intersection spacing: 600–700 feet, with many driveways.
- Network pattern: Suburban curvilinear; few alternative parallel routes.
- Center turn lane: TWLTL with turn bays at intersections.
- Transit: moderate-frequency regional and local routes.
- Bicycle facilities: designated bicycle route with 8-foot-wide paved shoulders on both sides.
- Narrow attached sidewalks (5 feet) on both sides.
- No landscaping within right of way.
- Conventional street and safety lighting.

Stage 2: Understand community vision for context and thoroughfare

Vision

Area plans envision a mix of high-density housing, retail centers and low-intensity commercial uses fronting the street. Because the roadway accommodates high levels of through traffic, access control is desired. The roadway is currently a bicycle route with bicyclists using the paved shoulder, but bicycle lanes are desired to close gaps in the bicycle system. Adjacent properties provide off-street parking, but some fronting residential and commercial uses would benefit from on-street parking. The area will generate pedestrians who desire buffering from adjacent traffic. The area plan calls for a boulevard design including an alternative for a multiway boulevard with fronting access lanes to provide on-street parking and buffer proposed mixed use development with ground floor retail and housing above.

Stage 3: Identify compatible thoroughfare types and context zones

- Existing context zone: C-3.
- Future context zone: C-5.
- Thoroughfare type: boulevard.

Stage 4: Develop and test the initial thoroughfare design

Desirable Design Elements (in prioritized order based on vision)

- Lower target speed (35 mph).
- Emphasis on vehicular capacity.
- Access management with landscaped median.
- Bicycle lanes.
- Streetside buffered from traffic.
- Street trees.
- Bus stops with shelters.
- Increased crossing opportunities at signalized intersections.
- Pockets of on-street parking adjacent to fronting commercial or mixed use development.
- Multiway boulevard design adjacent to mixed use development.

Factors to Consider/Potential Trade-Offs

- Effective width for streetside buffer versus width requirements for elements in traveled way.
- Accommodation of wider than minimum sidewalks, particularly in commercial areas.
- Provision of on-street parking in select segments versus other design elements.
- Intersections spaced to optimize traffic flow versus need for increased crossing opportunities.
- Accommodation of large vehicles, particularly turning at intersections.
- Right-of-way requirements for implementing a multiway boulevard.
- Efficient intersection operations with multiway boulevard.

Alternative Solutions (see Figure 6.22)

1. Emphasize streetside buffering and provision of bike lanes; provide minimal width median for access control and narrower travel lanes.
2. Implement multiway boulevard with local access streets that provide on-street parking and shared bicycle/vehicle environment. This allows a wider streetside area and removes bicycles from higher-speed roadway. This configuration requires 15 feet of right-of-way acquisition on each side of roadway, or adjacent development dedicates streetside and on-street parking lane.
3. Emphasize landscaped median and bicycle lanes by narrowing streetside. Provides minimal sidewalk width and reduced buffer area.

In all cases use grid network to divert some traffic from project thoroughfare. This may require operational or physical improvements to other streets. Traffic to be diverted will depend on travel patterns, context and design of other thoroughfares.

Compare benefits of the three alternatives. **Figure 6.23** demonstrates one way of showing such a comparison.

Selected Alternative

Alternative #2:

- Provides desirable design features, including the desire for a multiway boulevard.

- Is feasible to implement in newly urbanizing area with redevelopment opportunities.
- Requires either dedication or right-of-way acquisition, but could be implemented in phases.
- Requires special design of intersections to maintain efficient operations.

Stage 5: Develop detailed thoroughfare design

Figures 6.24 through **6.26** show a schematic view of how the selected alternative might be designed.

Solution Design Features

Traveled Way:

- Target speed: 35 mph.
- Four, 11-foot travel lanes in central roadway.
- Parallel, 18-foot-wide local access lanes separated by 8-foot-wide landscaped medians.
- Local access roads provide shared vehicle/bicycle lane and 9-foot travel lane.
- Left turn lanes on central roadway at intersections.

Streetside:

- 12-foot sidewalks.
- Pedestrian-scaled lighting.
- Street trees in tree wells.

Intersections:

- Special design treatment required to accommodate multiple movements between central roadway and local access lanes.
- Intersections widened to accommodate left-turn lane within the central roadway.

Parallel thoroughfares (as needed):

- Directional signing.
- Operational adjustments or improvements.
- Physical improvements.



Figure 6.20 View of existing street. Source: Kimley-Horn and Associates, Inc.

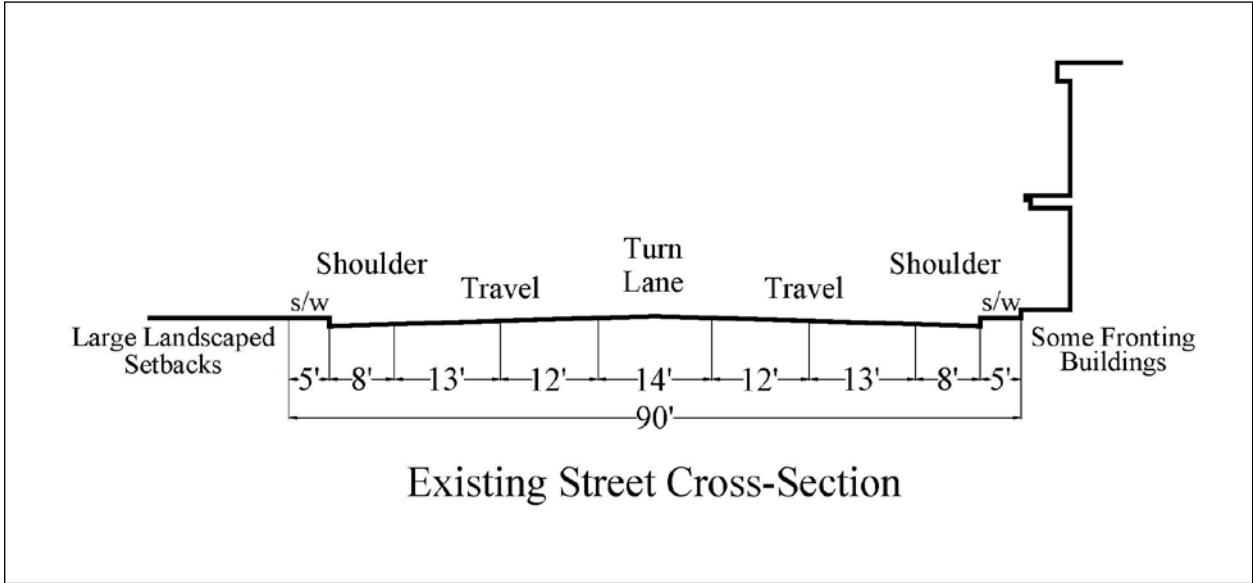

Figure 6.21 Existing street cross-section. Source: Kimley-Horn and Associates, Inc.

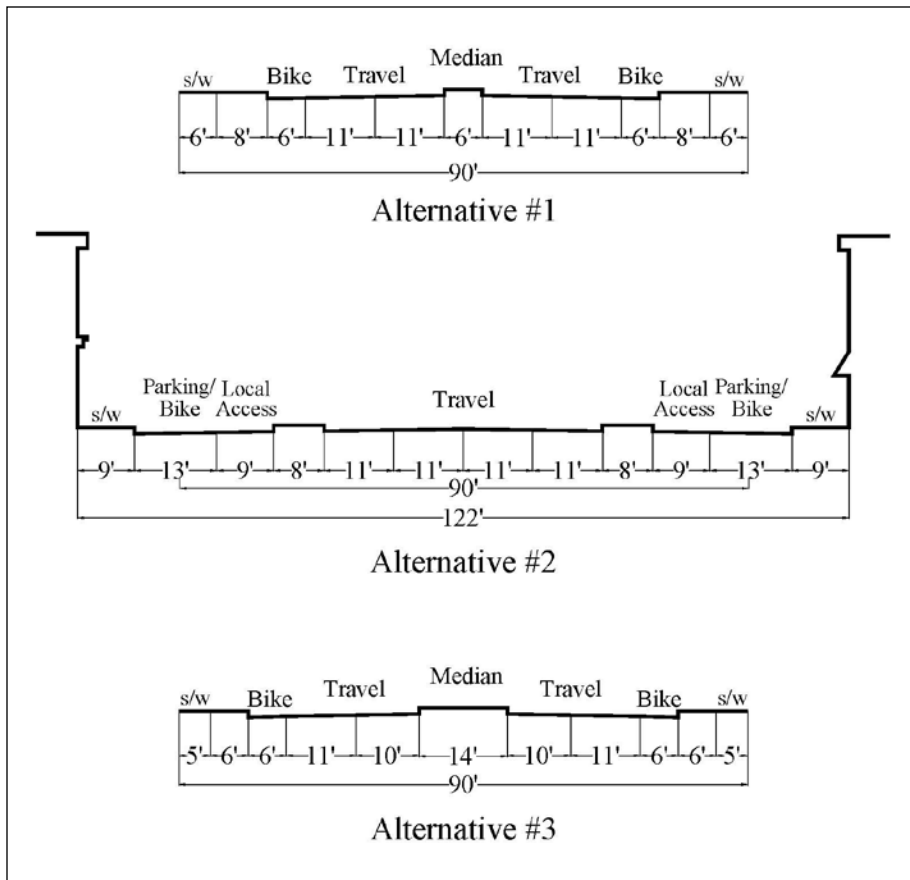

Figure 6.22 Alternative street cross-sections. Source: Kimley-Horn and Associates, Inc.

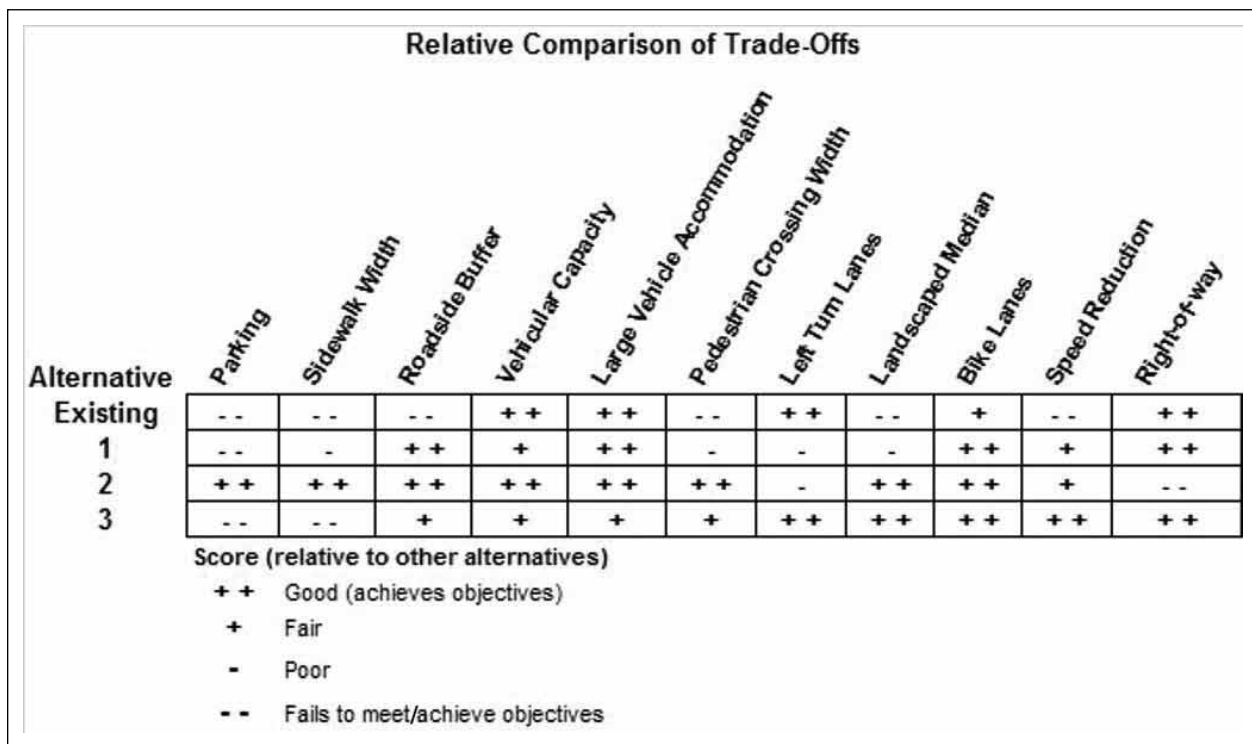

Figure 6.23 Relative comparison of alternative trade-offs. Source: Kimley-Horn and Associates, Inc.

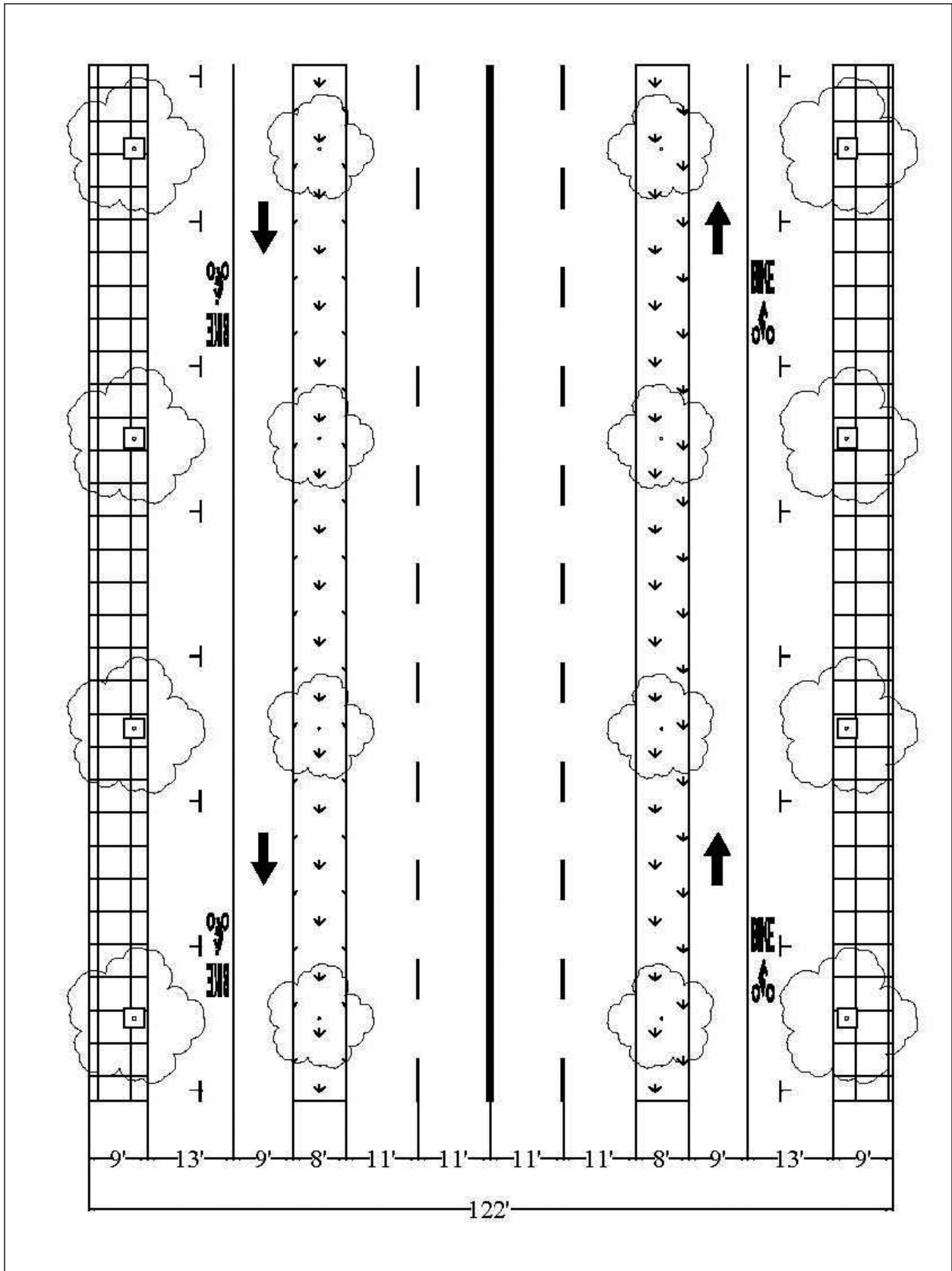

Figure 6.24 Schematic plan view of Alternative #2. Source. Kimley-Horn and Associates, Inc.

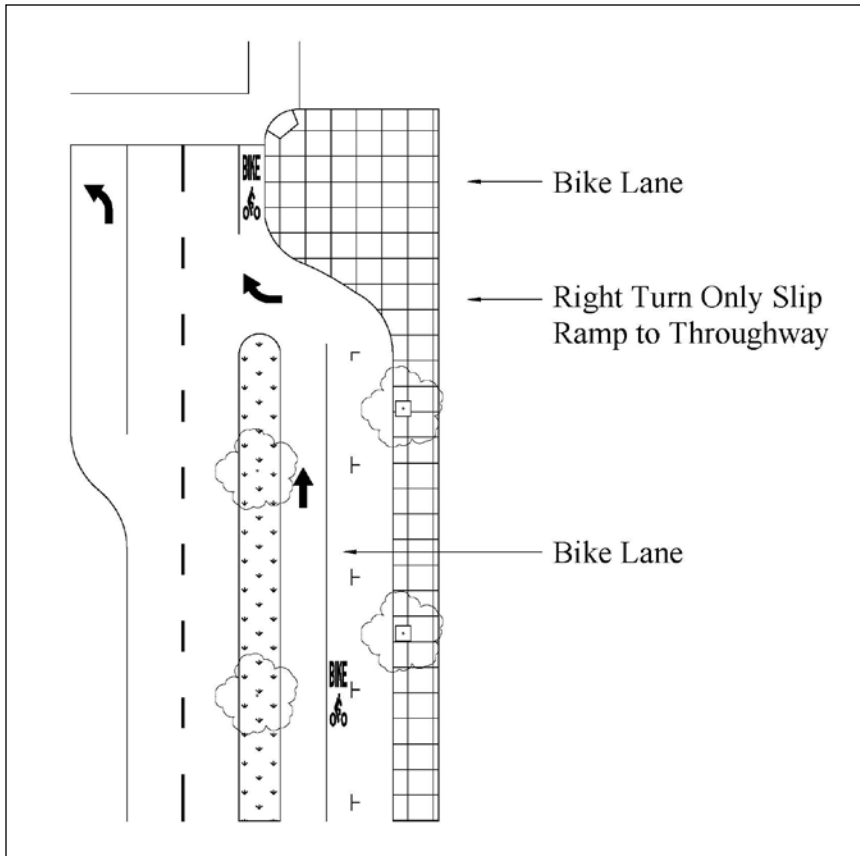

Figure 6.25 Alternative intersection design for Alternative #2. Source: Kimley-Horn and Associates, Inc.

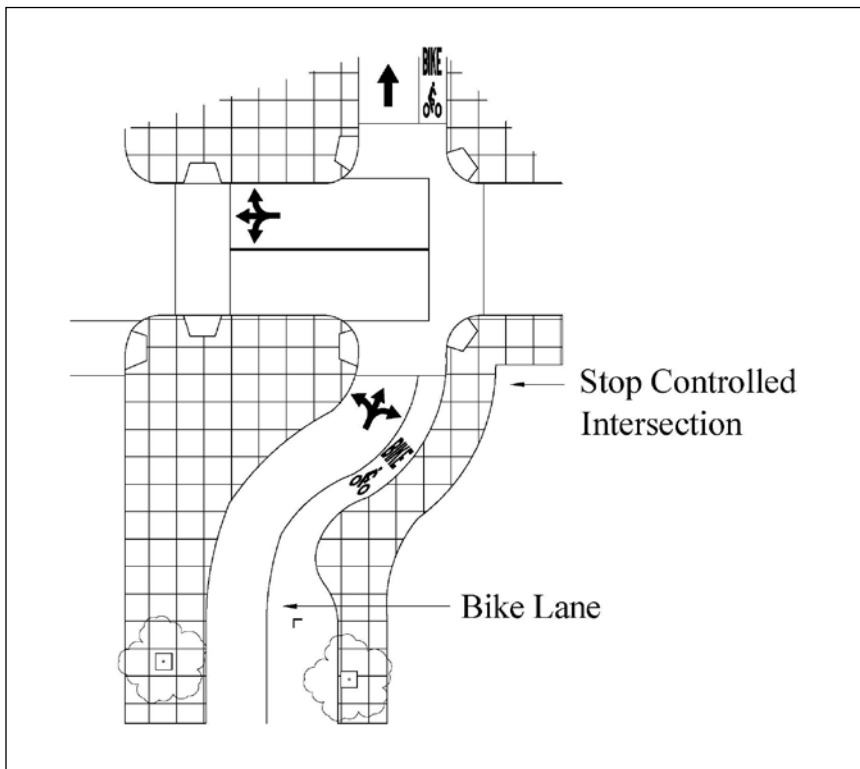

Figure 6.26 Alternative intersection design for Alternative #2. Source: Kimley-Horn and Associates, Inc.

Design Example #4: Central Business District Four- to Three-Lane Conversion

Objective

Convert an undivided four-lane arterial with parking on one side to three lanes plus parking and bicycle lanes on both sides in a central business district. The purpose of the conversion is to increase on-street parking, provide width for bicycle lanes and remove turning traffic from through lanes.

Stage 1: Review or develop an area transportation plan

Existing Street Characteristics (see Figures 6.27 and 6.28)

Existing street is a four-lane undivided arterial street with the following characteristics:

- Functional classification: minor arterial.
- Right of way: 100 feet.
- Four through-traffic lanes plus parallel parking on one side.
- Existing ADT: 12,000–15,000 vpd.
- Projected ADT: 18,000 vpd.
- Speed limit: 30 mph.
- Percent heavy vehicles: 2 percent.
- Intersection spacing: 400 feet.
- Network pattern: traditional downtown grid.
- Center turn lane: none.
- Transit: high-frequency regional and local routes.
- Bicycle facilities: designated bicycle route.
- 20-foot-wide sidewalks.
- Street trees in tree wells.
- Conventional street and safety lighting and pedestrian-scale lighting on sidewalks.

Stage 2: Understand community vision for context and thoroughfare

Vision

The central business district is not envisioned to change significantly in terms of its context. It will remain the

highest-intensity development in the city with a mix of commercial uses, ground floor retail and office above. The district has very high levels of pedestrian and transit use; however, new high-rise residential development is increasing the downtown population. There is continued demand for on-street parking and an anticipated increase in pedestrian and bicycle travel as new residents increase 24-hour activities. The city has been implementing its bicycle plan over time by adding bicycle lanes to many of the arterial streets. The traffic engineering department continues to look for opportunities to improve intersection operations and pedestrian safety by adding left-turn bays, curb extensions and protected-only left-turn signal phasing.

Stage 3: Identify compatible thoroughfare types and context zones

- Existing context zone: C-6.
- Future context zone: C-6.
- Thoroughfare type: avenue.

Stage 4: Develop and test the initial thoroughfare design

Desirable Design Elements

- Lower target speed (25 mph).
- Emphasis on pedestrian safety.



Figure 6.27 View of existing street. Source: Kimley-Horn and Associates, Inc.

- Improved operations at intersections.
- Bicycle lanes as part of city's master bicycle plan.
- Retention of wide sidewalks.
- Street trees.
- Far-side bus stops with shelters.
- Maximization of on-street parking.
- Reduced crossing width.

Factors to Consider/Potential Trade-Offs

- Vehicular capacity versus width required for all desirable elements.
- Efficiency/safety benefits of turn lanes and protected-only left-turn signal phasing versus four travel lanes.
- Provision of on-street parking in select segments versus other design elements.
- Accommodation of large vehicles, particularly turning at intersections, versus curb extensions and reduced crossing width.
- Ability to bypass double-parked vehicles and emergency vehicle access versus reduced number of lanes.
- Effective turning radius with addition of bicycle lanes.
- Addition of bicycle lanes on major transit route and conflicts with stopped buses.

Alternative Solution (see Figure 6.29)

Only one alternative design is considered in this design example:

1. Reduce number of through lanes to one in each direction; add an alternating center turn lane, on-street parking and bicycle lanes on both sides. Implement curb extensions at intersections. Retain existing streetside width.

In all cases the existing grid network may need to divert some traffic from project thoroughfare so a reduced number of traffic lanes will suffice. Traffic diversion could require operational or physical improvements to other streets.

Compare benefits of the existing and alternative conditions. **Figure 6.30** demonstrates one way of showing such a comparison.

Selected Alternative

Alternative #1:

- Projected traffic volumes can be accommodated with two lanes, and added turning lane improves intersection operations.
- Substantial parking supply added.
- Addition of bicycle lanes on both sides of the roadway closes gaps in the bicycle network and improves safety.
- Curb extensions and protected-only left-turn signal phasing provide substantial pedestrian benefit by reducing crossing distance, improving visibility and eliminating left-turn conflicts.

Stage 5: Develop detailed thoroughfare design

Figure 6.31 shows a rough schematic view of how the selected alternative might be designed.

Solution Design Features

Traveled Way:

- Target speed: 25 mph.
- Two 11-foot travel lanes and 12-foot alternating center turn lane.
- Combined 13-foot-wide parking/bike lanes on both sides.

Streetside:

- Retain existing 20-foot streetsides, pedestrian-scaled lighting and street trees in tree wells.

Intersections:

- Curb extensions and protected-only left-turn signal phasing.

Parallel thoroughfares (as needed):

- Directional signing.
- Operational adjustments or improvements.
- Physical improvements.

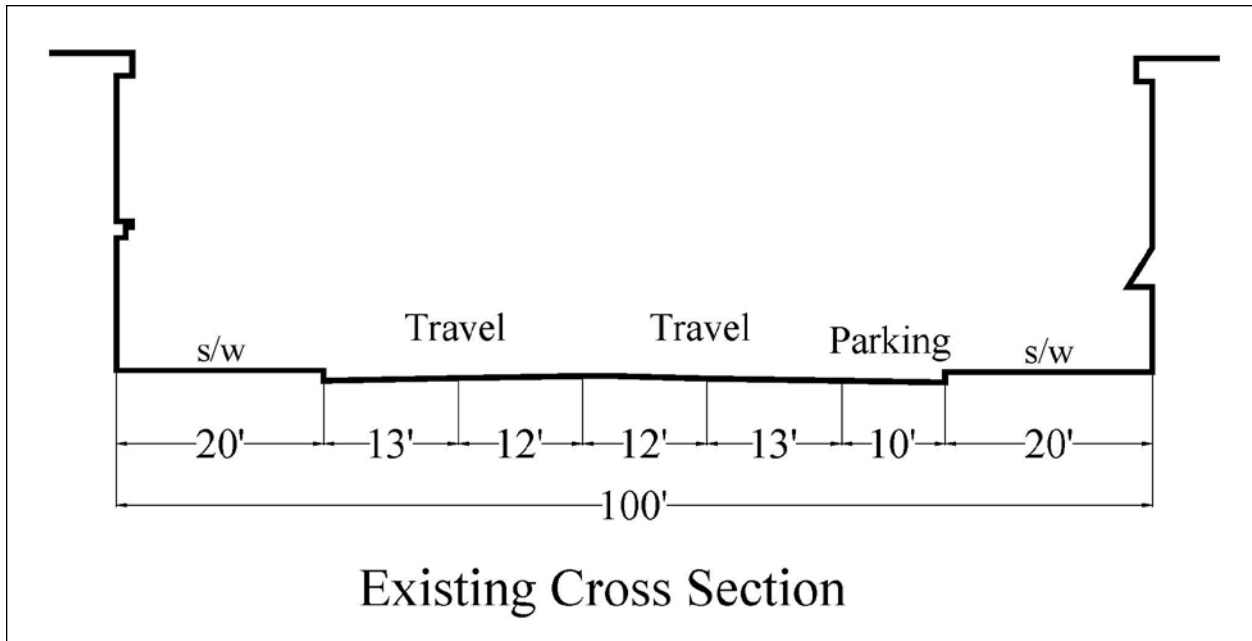

Figure 6.28 Existing street cross-section. Source: Kimley-Horn and Associates, Inc.

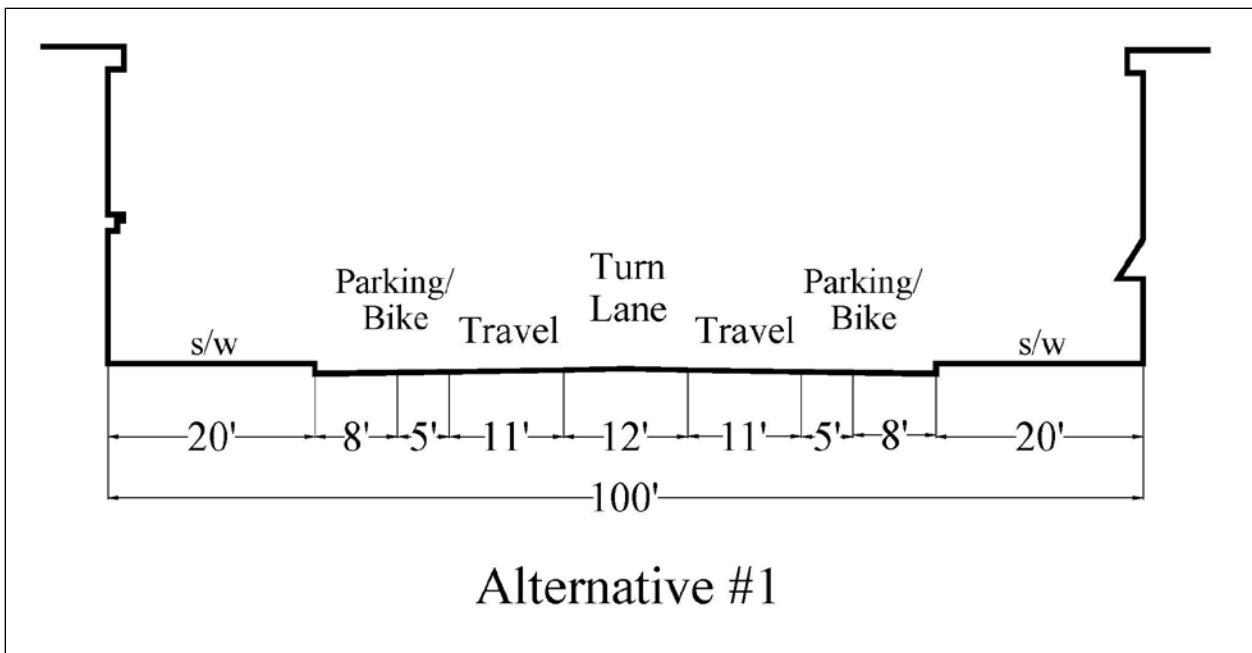

Figure 6.29 Alternative street cross-section. Source: Kimley-Horn and Associates, Inc.

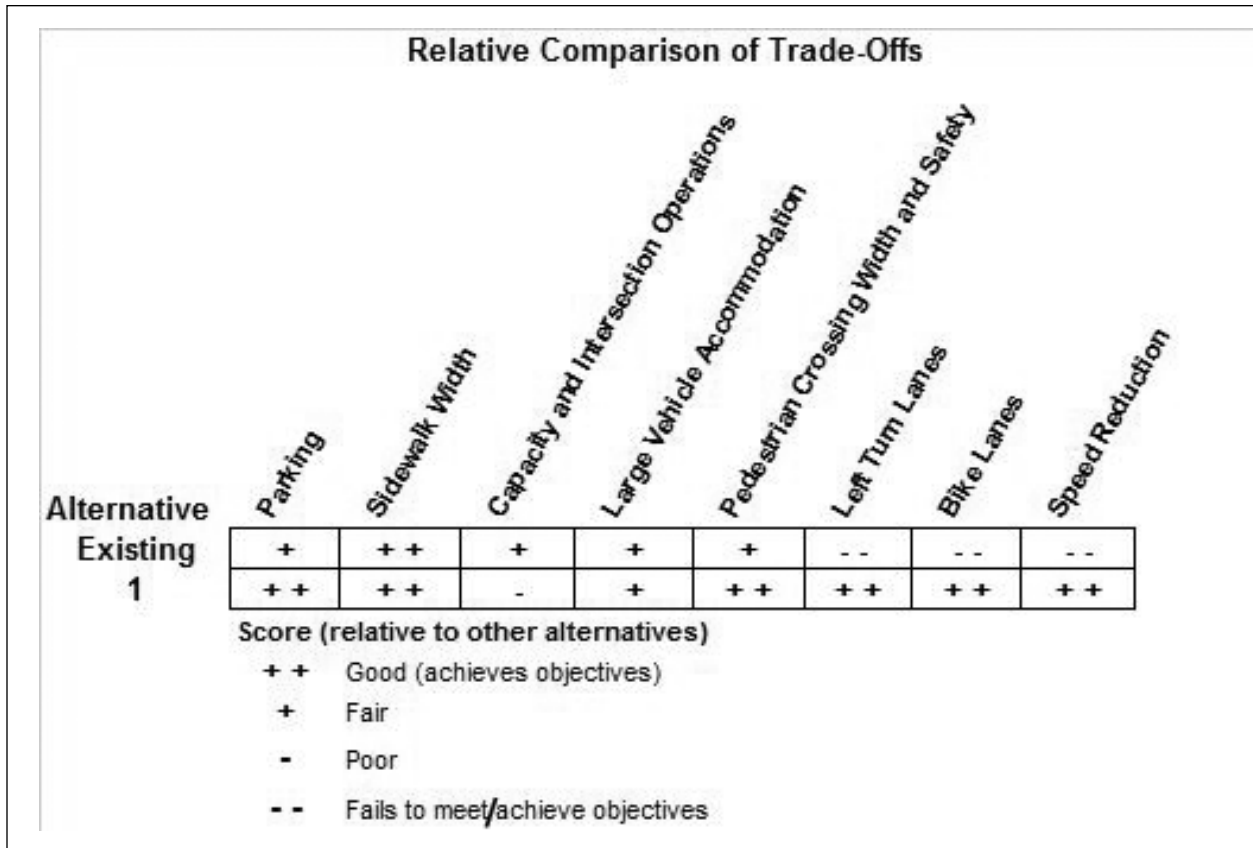

Figure 6.30 Relative comparison of alternative trade-offs. Source: Kimley-Horn and Associates, Inc.

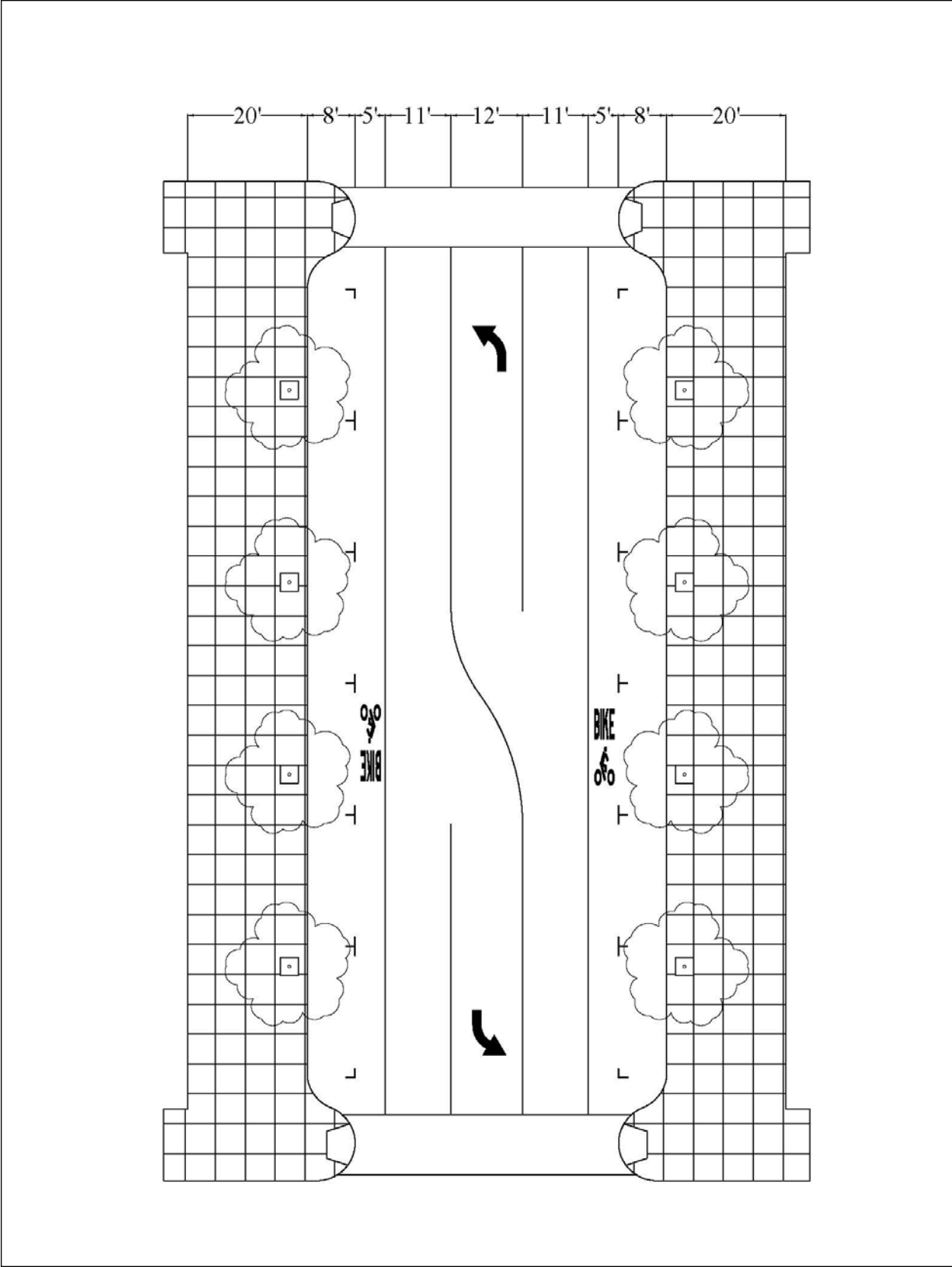

Figure 6.31 Schematic plan view of Alternative #1. Source: Kimley-Horn and Associates, Inc.

Works Cited

Jacobs, Allan. *Great Streets*. MIT Press. 1993.

Sources of Additional Information

Jacobs, A., Macdonald, E. and Rofé, Y. 2002. *The Boulevard Book: History, Evolution, Design of Multi-Way Boulevards*. Cambridge, MA: MIT Press.

Jacobs, A., Macdonald, E. and Rofé, Y. 1995. “Multiple Roadway Boulevards: Case Studies, Designs, Design Guidelines.” Working Paper No. 652. Berkeley, CA: University of California, Berkeley—Institute of Urban and Regional Development.

MacDonald, Elizabeth. “Building a Boulevard.” *Access*, issue number 28. Spring 2006.

Rosales, Jennifer. *Road Diet Handbook: Setting Trends for Livable Streets*. PB 2004. William Barclay Parsons Fellowship, Monograph 20, Second Edition, 2007.

Main Streets: Flexibility in Design and Operations. State Guidelines and Standards California Department of Transportation. Accessible via www.dot.ca.gov/hg/oppd/guidance.htm.

When Main Street is a State Highway: A Handbook for Communities and Designers. Maryland Department of Transportation, State Highway Administration. Accessible via www.sha.state.md.us/ohd/mainstreet.htm.

Oregon Department of Transportation. 1999. *Main Street... When a Highway Runs Through It: A Handbook for Oregon Communities*. Portland, OR: Oregon Department of Transportation.

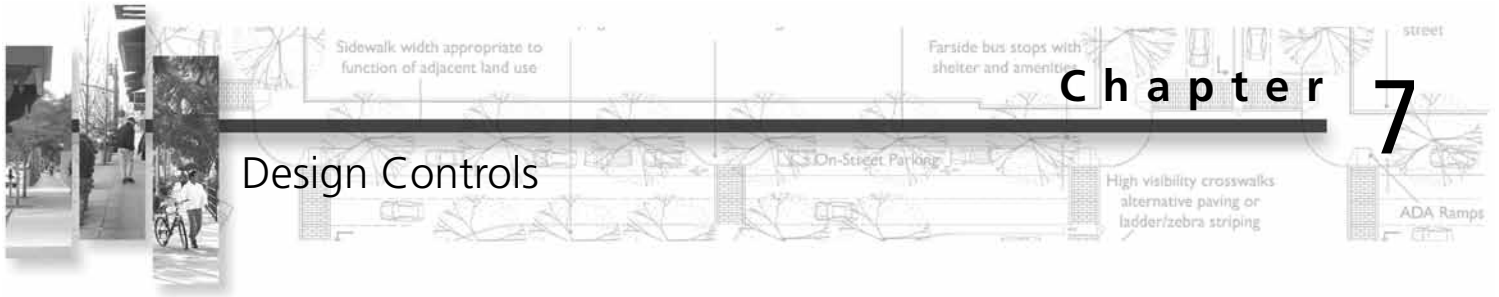

Purpose

This chapter discusses the fundamental design controls that govern urban thoroughfare design. This chapter is a prelude to the following chapters that present detailed design guidance for the streetside, traveled way and intersections. This chapter identifies the consistencies and divergences between design controls used where capacity is the dominant consideration and where walkability and the character of the thoroughfare is the dominant consideration.

Objectives

This chapter:

1. Defines the term “design controls” and identifies the controls used in the conventional design process;
2. Identifies design controls used in the CSS process and explains how they differ from conventional practice;
3. Discusses the concept of a “target speed” for selecting design criteria;
4. Identifies factors that can be used in thoroughfare design to influence speed;
5. Discusses the concept of a “control vehicle” in combination with a design vehicle to select intersection design criteria; and
6. Provides an overview of the design controls recommended.

Introduction

Controls are physical and operational characteristics that guide the selection of criteria in the design of thoroughfares. Some design controls are fixed—such as terrain, climate and certain driver-performance characteristics—but most controls can be influenced in some way through design and are determined by the designer.

The American Association of State Highway and Transportation Officials (AASHTO) Green Book and its supplemental publication, *A Guide for Achieving Flexibility in Highway Design* (2004b), identify location as a design control and establish different design criteria for rural and urban settings. AASHTO recognizes the influence context has on driver characteristics and performance. The Green Book defines the environment as “the totality of humankind’s surroundings: social, physical, natural and synthetic” and states that full consideration to environmental factors should be used in the selection of design controls. This report focuses on design controls and critical design elements in the urban context.

Design Controls Defined by AASHTO

AASHTO guidelines identify functional classification and design speed as primary factors in determining highway design criteria. The Green Book separates its design criteria by both functional classification and context—rural and urban. The primary differences between contexts are the speed at which the facilities operate, the mix and characteristics of the users and the constraints of the surrounding context.

In addition to functional classification, speed and context, AASHTO presents other design controls and criteria that form the basis of its recommended design guidance. The basic controls are:

- Design vehicle;
- Vehicle performance (acceleration and deceleration);
- Driver performance (age, reaction time, driving task, guidance and so forth);
- Traffic characteristics (volume and composition);
- Capacity and vehicular level of service;
- Access control and management;
- Pedestrians and bicyclists; and
- Safety.

AASHTO's Green Book presents the pedestrian needs as a factor in highway design and recognizes the pedestrian as the "lifeblood of our urban areas." Pedestrian characteristics that serve as design controls include walking speed, walkway capacity and the needs of persons with disabilities. AASHTO's *Guide for the Planning, Design and Operation of Pedestrian Facilities* (2004c) and *Guide for the Development of Bicycle Facilities* (1999) expand significantly on the Green Book, presenting factors, criteria and design controls. This report emphasizes pedestrians and bicyclists as a design control in all contexts but particularly in the walkable, mixed-use environments primarily addressed.

Differences from Conventional Practice

This report presents design guidance that is generally consistent with the AASHTO Green Book, AASHTO's supplemental publications and conventional engineering practice. There are, however, four design controls in the application of CSS principles that are used differently than in the conventional design process. These controls are:

- Speed;
- Location;
- Design vehicle; and
- Functional classification.

Speed

The most influential design control, and the design control that provides significant flexibility in urban areas, is speed. Thoroughfare design should be based on target speed.

Target speed is the highest speed at which vehicles should operate on a thoroughfare in a specific context, consistent with the level of multimodal activity generated by adjacent land uses to provide both mobility for motor vehicles and a safe environment for pedestrians and bicyclists. The target speed is designed to become the posted speed limit. In some jurisdictions, the speed limit must be established based on measured speeds. In these cases, it is important for the design of the thoroughfare to encourage the

desired operating speed to ensure actual speeds will match the target speed.

Conventionally, design speed—the primary design control in the AASHTO Green Book—has been encouraged to be as high as is practical. In this report, design speed is replaced with target speed, which is based on the functional classification, thoroughfare type and context, including whether the ground floor land uses fronting the street are predominantly residential or commercial. Target speed then becomes the primary control for determining the following geometric design values:

- Minimum intersection sight distance;
- Minimum sight distance on horizontal and vertical curves; and
- Horizontal and vertical curvature.

Target speed ranges from 25 to 35 mph for the primary thoroughfare types described in this report. A lower target speed is a key characteristic of thoroughfares in walkable, mixed use, traditional urban areas.

Design Factors that Influence Target Speed

Establishing a target speed that is artificially low relative to the design of the roadway will only result in operating speeds that are higher than desirable and difficult to enforce. Consistent with AASHTO, this report urges sound judgment in the selection of an appropriate target speed based on a number of factors and reasonable driver expectations. Factors in urban areas include transition from higher- to lower-speed roadways, terrain, intersection spacing, frequency of access to adjacent land, type of roadway median, presence of curb parking and level of pedestrian activity. AASHTO's *A Guide for Achieving Flexibility in Highway Design* (2004c) aptly summarizes the selection of speed in urban areas:

"Context-sensitive solutions for the urban environment often involve creating a safe roadway environment in which the driver is encouraged by the roadway's features and the surrounding area to operate at lower speeds."

Urban thoroughfare design for walkable communities should start with the selection of a target speed. The target speed should be applied to those geometric design elements where speed is critical to safety, such as horizontal and vertical curvature and intersection sight distance. The target speed is not set arbitrarily but rather is achieved through a combination of measures that include the following:

- Setting signal timing for moderate progressive speeds from intersection to intersection;
- Using narrower travel lanes that cause motorists to naturally slow their speeds;
- Using physical measures such as curb extensions and medians to narrow the traveled way;
- Using design elements such as on-street parking to create side friction;
- Minimal or no horizontal offset between the inside travel lane and median curbs;
- Eliminating superelevation;
- Eliminating shoulders in urban applications, except for bicycle lanes;
- Smaller curb-return radii at intersections and elimination or reconfiguration of high-speed channelized right turns;
- Paving materials with texture (e.g., crosswalks, intersection operating areas) detectable by drivers as a notification of the possible presence of pedestrians; and
- Proper use of speed limit, warning, advisory signs and other appropriate devices to gradually transition speeds when approaching and traveling through a walkable area.

Other factors widely believed to influence speed include a canopy of street trees, the enclosure of a thoroughfare formed by the proximity of a wall of buildings, the striping of edge lines or bicycle lanes, or parking lanes. These are all elements of walkable, mixed-use urban areas but should not be relied upon as speed-reduction measures until further research provides a definitive answer.

The practitioner should be careful not to relate speed to capacity in urban areas, avoiding the perception that a high-capacity street requires a higher target speed. Under interrupted flow conditions, such as on thor-

oughfares in urban areas, intersection operations and delay have a greater influence on capacity than speed.

The *Highway Capacity Manual* (TRB 2000) classifies urban streets (Class I through IV) based on a range of free-flow speeds. The thoroughfares upon which this report focuses have desired operating speeds in the range of 25 to 35 mph (Class III and IV based on the *Highway Capacity Manual*). Level of service C or better is designated by average travel speeds ranging from 10 to 30 mph. Therefore, adequate service levels can be maintained in urban areas with lower operating speeds. Capacity issues should be addressed with highly connected networks; sound traffic operations management, such as coordinated signal timing; improved access management; removal of unwarranted signals; and the accommodation of turning traffic at intersections.

Location

Conventional thoroughfare design is controlled by location to the extent that it is rural or urban (sometimes suburban). This report broadens the choices for context using the urban transect, ranging from suburban to high-density urban cores. Additionally, the variation in design elements controlled by location is expanded to include predominant ground floor uses such as residential or commercial. Land uses govern the level of activity, which in turn influences the design of the thoroughfare. These influences include, but are not limited to, pedestrians and bicyclists, transit, economic activity of adjacent uses and right-of-way constraints. The CSS approach may also consider planned land uses that represent a departure from existing development patterns and special design districts that seek to protect scenic, environmental, historic, cultural, or other resources.

Design Vehicle

The design vehicle influences the selection of design criteria such as lane width and curb-return radii. Some practitioners will conservatively select the largest design vehicle (WB 50 to WB 67) that could use a thoroughfare, regardless of the frequency. Consistent with AASHTO, CSS emphasizes an analytical approach in the selection of a design vehicle, including evaluation of the trade-offs involved in selecting one design vehicle over another.

In urban areas it is not always practical or desirable to choose the largest design vehicle that might occasionally use the facility, because the impacts to pedestrian crossing distances, speed of turning vehicles and so forth may be inconsistent with the community vision and goals and objectives for the thoroughfare. In contrast, selection of a smaller design vehicle in the design of a facility regularly used by large vehicles can invite frequent operational problems. The practitioner should select the design vehicle that will use the facility with considerable frequency (for example, bus on bus routes, semi-tractor trailer on primary freight routes or accessing loading docks and so forth). Two types of vehicle are recommended:

- Design vehicle—must be regularly accommodated without encroachment into the opposing traffic lanes. A condition that uses the design vehicle concept arises when large vehicles regularly turn at an intersection with high volumes of opposing traffic (such as a bus route).
- Control vehicle—infrequent use of a facility must be accommodated, but encroachment into the opposing traffic lanes, multiple-point turns, or minor encroachment into the streetside is acceptable. A condition that uses the control vehicle concept arises when occasional large vehicles turn at an intersection with low opposing traffic volumes (such as a moving van in a residential neighborhood or once-per-week delivery at a business) or when large vehicles rarely turn at an intersection with moderate to high opposing traffic volumes (such as emergency vehicles).

In general, the practitioner should obtain classification counts to determine the mix of traffic and frequency of large vehicles and should estimate how this mix will change as context changes and keep consistent with the community's long-range vision. If there are no specific expectations, the practitioner may consider the use of a single-unit truck as an appropriate design vehicle.

Although state highways have traditionally served through and heavy/large vehicle traffic, modern thoroughfare system planning tries to accommodate movements where they are best handled from a network and context consideration. Large, heavy and unusually demanding vehicles need to be accommodated with reasonable convenience. However, in some

Multimodal Level of Service Measures

A fundamental goal of CSS is to effectively serve all modes of travel. Although good network planning, access management and innovative street designs can provide significant vehicle capacity while accommodating bicycles and pedestrians, trade-offs among modes can be an issue. Evaluating these trade-offs has historically been hampered by the fact that performance measures were developed primarily to measure vehicle movement. However, the traditional *Highway Capacity Manual* level of service framework has been adapted to evaluate performance from a transit, pedestrian and bicycle perspective.

These multimodal performance measures focus as much on the quality and convenience of facilities as they do on movement and flow. For example, the adequacy of pedestrian facilities is not determined by how crowded a sidewalk is but by the perception of comfort and safety. For transit services, frequency is an important attribute, but “on-time performance” and the pedestrian environment surrounding bus and rail stations are also critical aspects of the traveler experience. Below are examples of multimodal performance measures.

Bicycle Level of Service Measures

- Effective width of the outside through lane
- Traffic volumes
- Traffic speeds
- Truck volumes

Pedestrian Level of Service Measures

- Existence of a sidewalk
- Lateral separation of pedestrians from motorized vehicles
- Motorized vehicle traffic volumes
- Motorized vehicle speeds

For more information on multimodal level of service, see References for Further Reading at the end of this chapter.

cases, routes other than state highways may be more appropriate or more easily accommodating. Any such diversions from state routes need to be clearly marked.

Chapter 10 (Intersection Design Guidelines) provides further guidance on the design of intersections to accommodate large vehicles.

Functional Classification

Functional classification describes a thoroughfare's theoretical function and role in the network, as well as governs the selection of certain design parameters, although the actual function is often quite different. As discussed in Chapter 4, functional class may influence some aspects of the thoroughfare such as its continuity through an area, trip purposes and lengths of trips accommodated, level of land access it serves, type of freight service and types of public transit served. These functions are important factors to consider in the design of the thoroughfare, but the physical design of the thoroughfare in CSS is determined by the thoroughfare type designation (as introduced in Chapter 4 and further discussed in Chapter 6).

The Role of Capacity and Vehicular Level of Service in CSS

The conventional design process uses traffic projections for a 20-year design period and strives to provide the highest practical vehicular level of service. CSS takes traffic projections and level of service into account and then balances the needs of all users or emphasizes one user over another depending on the context and circumstances (for example, reduces number of mixed-flow travel lanes to accommodate bicycle lanes or an exclusive busway). While capacity and vehicular level of service play a role in selecting design criteria, they are only two of many factors the practitioner considers and prioritizes in the design of urban thoroughfares. Often in urban areas, thoroughfare capacity is a lower priority than other factors such as economic development or historical preservation, and higher levels of congestion are considered acceptable. The priority of level of service is a community objective; however, variance from the responsible agency's adopted performance standards will require concurrence from that agency. CSS also considers network capacity in determining the necessary capacity of the individual thoroughfare (see Chapter 3).

Thoroughfare Speed Management

Under the conventional design process, many arterial thoroughfares have been designed for high speeds and traffic volumes. As the context of these thoroughfares change over time, such as to walkable compact mixed-use areas, the speed encouraged by the design becomes a matter of concern. Further, municipalities establishing speed limits based on the measured 85th percentile speed are finding they are required to establish higher speed limits than the community desires for the area. In these cases, traffic engineers are tasked with identifying methods to reduce arterial speeds. This section identifies research and the practical experience of agencies in managing arterial speeds.

It is popularly held that higher operating speeds result in higher crash rates and higher severity of crashes. Research on the effect of actual operating speed on crash rate is inconclusive (TRB 1998). However, research does show that higher operating speeds do result in higher crash severity—higher percentages of injury and fatality crashes and more serious property damage. Hence, lower vehicular traffic speeds will be beneficial when collisions occur with other vehicles or pedestrians.

Speed management is an approach to controlling speeds using enforcement, design and technology applications. While “traffic calming” is a type of speed management usually used on local residential streets, speed management can be used on all types of thoroughfares. Speed management methods can use technologies that provide feedback to the motorist about their speed, or designs in which the motorist perceives the need for a lower speed. These techniques include signage, signalization, enforcement, street designs and built environments that encourage slower speeds. Other methods include physical devices that force drivers to slow down, such as roundabouts, raised intersections, or narrowed sections created by curb extensions and raised medians. Physical devices are generally more effective at changing driver behavior but may be more costly to implement and may not be appropriate on all thoroughfares.

Speed management is often a multidisciplinary decision because it requires input from emergency services, engineering, street maintenance departments,

law enforcement and transit service providers. The process of implementing a speed management program benefits from public involvement to understand how the community uses thoroughfares and how it perceives various speed management methods. Bicycle and pedestrian advocacy groups should also be involved in the process. Effective speed management requires knowledge of the existing traffic patterns, both quantitative and qualitative. Quantitative measures of traffic counts, intersection turn movements and speeds help to determine the existing condition and the need. Qualitative information, often gathered from the public or through observation, can explain behavioral issues. Implementation of speed management should be examined along corridors and across jurisdictions. It is important for a corridor to have a consistent speed through different jurisdictions if the character and context also remain constant.

The following is a list of speed management techniques or measures commonly used in the United States on thoroughfares designated as arterials or collectors:¹

Active Measures

- Roundabouts, particularly when used within a “roundabout corridor.”
- Road diets (reducing the number of lanes by adding medians, converting travel lanes to parking, or adding bike lanes).
- Lateral shifts or narrowing (curb extensions with a center island or other techniques that require vehicles to move out of a straight path or create neckdowns).
- Smaller curb-return radii to slow turning vehicles and the elimination of free-flow channelized right-turn lanes.
- Provision of on-street parking where adjacent land uses and activities will generate demand.

- Speed humps and speed tables (not widely used on arterials and lack support of emergency service providers).
- Speed cushions or speed platforms (less impact on emergency vehicles than hump and tables).
- Narrowed travel lanes.
- Raised crosswalks combined with curb extensions to narrow street.
- Speed actuated traffic signals where a vehicle traveling at excessive speeds will trigger the signal to change to red.

Passive Measures

- Synchronized signals to create progression at an appropriate speed.
- Radar trailers/speed feedback signs flashing “SLOW DOWN” message when speed exceeds a preset limit (most effective when coupled with enforcement).
- Visually narrowing road using pavement markings.
- Visually enclosing street with buildings, landscaping and street trees.
- Variable speed limits (using changeable message signs based on conditions).
- Speed enforcement corridors combined with public education.
- Flashing beacons on intersection approaches to slow traffic through the intersection.
- Speed limit markings on pavement.
- Mountable cobblestone medians or flush concrete bands delineating travel lanes for visual narrowing
- Shared streets using signs and pavement markings (such as bicycle boulevards).
- Automated speed enforcement (including red-light enforcement).

¹ Based on interviews with public agencies and experts in the field of speed management. Source: “Best Practices in Arterial Speed Management,” prepared for the City of Pasadena. Kimley-Horn and Associates, Inc, and *ITE Journal* article “Complete Streets: We Can Get There From Here,” LaPlante, J. and McCann, B., May 2008.

Additional Controls to Consider in Thoroughfare Design

In addition to the design controls discussed previously, other critical design controls in the conventional de-

sign process remain applicable in the application of CSS principles. Design controls related to roadway geometry—sight distance, horizontal and vertical alignment and access control—continue to be based on conventional design practices.

Pedestrian and Bicyclist Requirements as Design Controls

Pedestrian and bicyclist requirements affect the utilization of a thoroughfare's right of way. Thoroughfares with existing or desired high levels of pedestrian and bicycle usage require appropriate streetside and bicycle facilities to be included in transportation projects. This requirement usually affects the design elements in the traveled way. Therefore, pedestrian and bicycle requirements function as design controls that influence decisions for the utilization and prioritization of the right of way. For example, requirements for bicycle lanes might outweigh the need for additional travel lanes or a median, resulting in a design that reduces the vehicular design elements to provide bicycle design elements. The design of walkable urban thoroughfares emphasizes allocating right of way appropriately to all modes depending on priority and as defined by the surrounding context and community objectives. This process results in a well thought out and rationalized design trade-off—the fundamental basis of context sensitive solutions.

Sight Distance

Sight distance is the distance that a driver can see ahead in order to observe and successfully react to a hazard, obstruction, decision point, or maneuver. Adequate sight lines remain a fundamental requirement in the design of walkable urban thoroughfares. The criteria presented in the AASHTO Green Book for stopping and signalized stop- and yield-controlled intersection sight distances based on the target speeds described above should be used in urban thoroughfare design.

Horizontal and Vertical Alignment

The design of horizontal and vertical curves is a controlling feature of a thoroughfare's design. The criteria for curvature is affected by speed and is dependent on the target speed. For urban thoroughfares, careful consideration must be given to the design of alignments to balance safe vehicular travel with a reasonable operating speed. The AASHTO Green Book

provides guidance on the design of horizontal and vertical alignments for urban streets.

Access Management

Access management is defined as the management of the interference with through traffic caused by traffic entering, leaving and crossing thoroughfares. Access management can be a regulatory, policy, or design tool. Access management on urban thoroughfares controls geometric design by establishing criteria for raised medians and median breaks, intersection and driveway spacing, and vehicle movement restrictions through various channelization methods. The AASHTO Green Book and the Transportation Research Board's *Access Management Manual* (2003) provide extensive guidance on this subject. Chapter 9 (Traveled Way Design Guidelines) provides an overview of access management methods and general guidelines for managing access on urban thoroughfares.

Works Cited

American Association of State Highway and Transportation Officials. 2004a. *A Policy on Geometric Design of Highways and Streets*. Washington, DC: AASHTO.

American Association of State Highway and Transportation Officials. 2004b. *A Guide for Achieving Flexibility in Highway Design*. Washington, DC: AASHTO.

American Association of State Highway and Transportation Officials. 1999. *Guide for the Development of Bicycle Facilities*. Washington, DC: AASHTO.

American Association of State Highway and Transportation Officials. 2004c. *Guide for the Planning, Design and Operation of Pedestrian Facilities*. Washington, DC: AASHTO.

Transportation Research Board. 2000. *Highway Capacity Manual*. Washington, DC: TRB.

Transportation Research Board. 2003. *Access Management Manual*. Washington, DC: TRB.

Transportation Research Board. 1998. *Speed Management*, Special Report 254. Washington, DC: TRB.

Sources of Additional Information

Parham, A. and Fitzpatrick, K. 1998. *Handbook of Speed Management Techniques*. Texas Transportation Institute.

Dowling, R. et al. 2008. NCHRP Report 616 *Multimodal Level of Service Analysis for Urban Streets*. Transportation Research Board, Washington, DC.

Dowling, R. 2008. NCHRP Web Document 128 *Multimodal Level of Service Analysis for Urban Streets: Users Guide*. Transportation Research Board, Washington, DC.

Florida Department of Transportation. 2002. *Quality/Level of Service Handbook*. Systems Planning Office, Tallahassee, FL.

Steiner, Ruth et al. 2003. *Multimodal Trade-off Analysis in Traffic Impact Studies*. Florida Department of Transportation Office of Systems Planning.

Williams, Kristine and Karen Seggerman. 2004. *Model Regulations and Plan Amendments for Multimodal Districts*. National Center for Transit Research and Florida Department of Transportation Systems Planning Office. Tallahassee, FL.

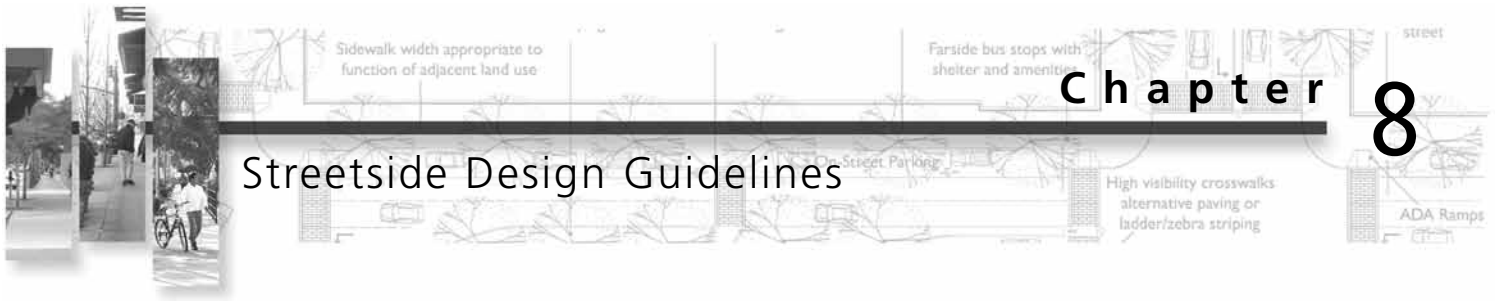

Purpose

This chapter provides principles and guidance for the design of a thoroughfare’s streetside and the specific elements that comprise the streetside. It addresses how the design of the streetside varies with changes in context. The guidance in this chapter is used in conjunction with the guidance for the other two thoroughfare components—the traveled way (Chapter 9) and intersections (Chapter 10).

Objectives

This chapter:

1. Defines and discusses four distinct zones that comprise the streetside: edge, furnishings, throughway and frontage;
2. Describes the uses and activities that are typically accommodated within the streetside in urban areas;
3. Describes fundamental design principles of the streetside as they relate to intersection sight distance, speed and clear zones and lateral clearance;
4. Describes the role and placement of streetside facilities, public spaces and public art; and
5. Provides principles, considerations and design guidance for streetside width and functional requirements.

Introduction

The streetside is the portion of the thoroughfare that accommodates nonvehicular activity—walking as well as the business and social activities—of the street. It extends from the face of the buildings or edge of the private property to the face of the curb. A well-designed streetside is important to the thoroughfare’s function as a “public place.” Thoroughfares are the most extensively used civic spaces or in our communities.

Streetside Zones and Buffering

This chapter addresses the design of sidewalks and the buffers between sidewalks, moving traffic, parking and/or other traveled-way elements. The streetside consists of the following four distinct functional zones:

1. Edge zone—the area between the face of curb and the furnishing zone that provides the minimum necessary separation between objects and activities in the streetside and vehicles in the traveled way;
2. Furnishings zone—the area of the streetside that provides a buffer between pedestrians and vehicles, which contains landscaping, public street furniture, transit stops, public signage, utilities and so forth;
3. Throughway zone—the walking zone that must remain clear, both horizontally and vertically, for the movement of pedestrians. The Americans with Disabilities Act (ADA) establishes a minimum width for the throughway zone; and
4. Frontage zone—the distance between the throughway and the building front or private property line that is used to buffer pedestrians from window shoppers, appurtenances and doorways. It contains private street furniture, private signage, merchandise displays and so forth and can also be used for street cafes. This zone is sometimes referred to as the “shy” zone.

Figure 8.1 illustrates the four zones using the example of a streetside in a commercial area. Guidance is provided for each of these zones, with the width varying in relation to thoroughfare type and function, context zone and specific land use characteristics.

Urban Design Elements

The streetside can contain a variety of urban design elements, ranging from large-scale elements such as plazas, seating areas, transit stops and other public

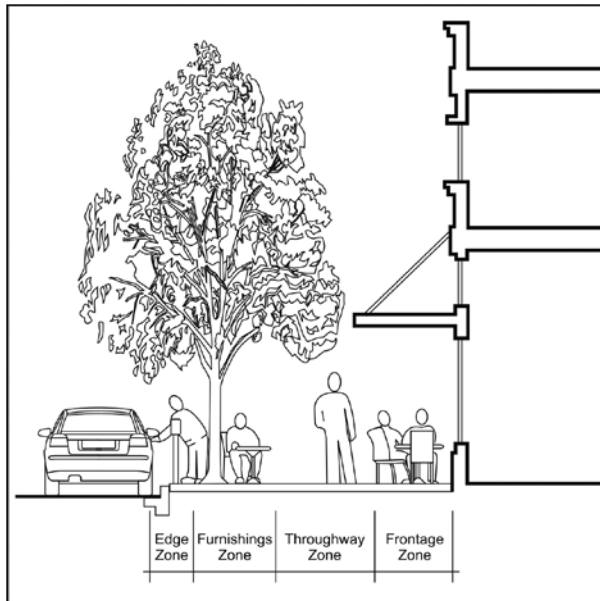

Figure 8.1 Streetside zones. Source: Concept by Community, Design + Architecture, illustration by Digital Media Productions.

spaces to the details of street furniture, street trees, public art and materials used for constructing sidewalks, walls and so forth.

Technical Considerations

There is a broad range of technical and engineering considerations that need to be coordinated with the design of the streetside, including the requirements of *Americans with Disabilities Act Accessibility Guidelines* (ADAAG) and *Public Rights-of-Way Accessibility Guidelines* (PROWAG) (www.access-board.gov/), need for utilities (including lighting for both the traveled way and streetside), provision of signage for traffic and pedestrians and evaluation of multimodal accessibility. This chapter provides guidance for how these technical issues can be addressed in coordination with the other elements of urban thoroughfares.

The Urban Streetside: Uses and Activities

The basic functions of the streetside in any context are the accommodation of pedestrians, access to adjoining buildings and properties and the provision of clear zones and space for utilities and other streetside appurtenances. In urban contexts these basic functions are shared with the activities generated by the

adjacent land use and general civic functions, which can include aesthetics (such as street trees and public art), sidewalk cafes, plazas and seating areas, transit amenities (such as benches, shelters, trash receptacles and waiting areas), merchandise display and occasional public activities (such as farmers' markets or art shows).

Streetside functions vary by context zone and predominant ground floor land use. The width of certain elements of the streetside (for example, the furnishings zone functions as a traffic buffer) will vary by thoroughfare type depending on the existence or lack of on-street parking and the speed and volume of vehicular traffic on the thoroughfare. Variations in the width of the streetside are addressed in the design guidelines in the section on streetside width and functional requirements.

Design Principles

Safety

When designing the streetside, the practitioner is concerned about the safety of all users of the thoroughfare. Streetside safety concerns in urban contexts are different than those in rural contexts, where speeds are higher and most travel is by vehicle. In designing the streetside for traditional walkable urban areas, the practitioner is concerned about the safety of a wider range of users, including pedestrians on the sidewalk, motorists, motorcyclists and bicyclists using the traveled way. The practitioner should consider the context of the thoroughfare, including competing demands within limited right of way and time when the space may be needed.

Streetside safety in urban areas is achieved by separating modes of different speeds and vulnerabilities to the extent possible by both space and time (bicyclists from pedestrians and pedestrians from vehicles), informing all users of the presence and mix of travel modes and through provision of adequate sight distance. The difficulty for the practitioner lies in developing solutions to resolve the inherent conflicts where modes of travel cross paths. Design guidelines for improving pedestrian safety at intersections are discussed in Chapter 10.

Streetside safety for the users of the traveled way in traditional urban areas focuses on meeting user expectations, providing uniform and predictable designs and traffic control, removing clearly hazardous streetside obstacles and establishing an appropriate target speed, which in turn controls the speed-related geometric design elements of the thoroughfare. The practitioner should be familiar with the concepts and guidance provided in AASHTO's *Roadside Design Guide* (2002).

Relationship of Speed to Streetside Design

A person's decision to walk is influenced by many factors, including distance, perceived safety and comfort, convenience and visual interest of the route (AASHTO 2004b). In the streetside, pedestrians feel exposed and vulnerable when walking directly adjacent to a high-speed travel lane. Vehicle noise, exhaust and the sensation of passing vehicles reduce pedestrian comfort. Factors that improve pedestrian comfort include a separation from moving traffic and a reduction in speed. In walkable urban environments, a buffer zone that improves pedestrian comfort can be achieved with the width of the edge and furnishings zones, landscaping and on-street parking.

Clear Zones

The application of a clear zone is most critical on high-speed roadways and is usually not implemented on low-speed urban thoroughfares with right-of-way constraints. In many cases the hazard of streetside obstacles is substantially less in urban areas because of lower speeds or parked vehicles.

Public Space

Civic and community functions on the streetside may require additional space to complement adjacent civic or retail land uses or to accommodate the high pedestrian flows of adjacent uses or transit facilities. Public spaces in the streetside are often used for these functions and are an important complement to the thoroughfare as a public place. Public spaces include public plazas, squares, outdoor dining, transit stops and open spaces. Transit stops and some plazas are generally within the streetside. Design considerations should account for the context of the public space within the thoroughfare and the surrounding land use context. Public spaces

should be designed to serve functions that enhance the surrounding context, such as public gatherings, special events, farmers' markets, quiet contemplation, lunch time breaks and so forth (**Figure 8.2**). General principles for the design of public spaces include the following:

- Public spaces in private property adjacent to the streetside should be visible and accessible from the streetside. These public spaces can accommodate higher levels of pedestrian activity at entries to major buildings or retail centers.
- Public spaces in the streetside should not impede the circulation of pedestrians and should provide appropriate features such as seating and lighting to make them attractive and functional places for people to use.
- The streetside and public space design should integrate the functions of both in a compatible and mutually supportive manner. Functions should interconnect by design.
- Special paving and materials may be used to unify the look of the sidewalk, parking lane and crosswalks.
- There should be a continuity of design in adjacent streetside and public spaces. This may include paving, lighting, landscape plants and materials and other features.
- Street trees, light fixtures, public art and other elements with a unified design can be used to highlight a segment of a thoroughfare that is specifically designed to function as a public gathering place.

Placement of Streetside Facilities

Following the division of the streetside into edge, furnishings, throughway and frontage zones, the placement of streetside facilities (such as kiosks and retail stands, trash receptacles, water fountains, restrooms, public art and small ancillary structures) should occur in the furnishings and frontage zones as well as in curb extensions. In no case should the placement of features reduce the width of the clear pedestrian throughway to less than 5 feet or reduce vertical clearance below 80 inches. All placements should be compliant with the most recent U.S. Access Board and PROWAG requirements and FHWA PROWAG guidelines: *Special Report: Ac-*



Figure 8.2 Public space adjacent to the pedestrian realm should relate to the activities on the thoroughfare. Source: Kimley-Horn and Associates, Inc.

cessible Public Rights-of-Way: Planning and Designing for Alterations.

Other considerations regarding streetside facilities are as follows:

1. Place facilities in locations where their use will produce pedestrian activity levels similar to a main street or where an activity focus is desired. Features such as public art should be located in highly visible areas, including the center islands of low-speed roundabouts (ensuring sight triangles are maintained and placement does not constitute a streetside hazard).
2. Select the type, design and materials of streetside facilities to reflect the local character of the context and streetside. This will maximize the facility's contribution to creating a sense of community identity.
3. Coordinate design elements (street furniture, light fixtures and poles, tree grates and so forth) to fit into a desired theme or unified style for a given thoroughfare. This can be best achieved through the preparation of a streetscape improvement plan.
4. Streetside facilities are particularly well suited for placement on very wide sidewalks or large curb extensions. Locate facilities at street corners in a manner that maintains clear sight triangles. (For more information, review the discussions on sight triangles and curb extensions in Chapter 10.)
5. Consider vehicle overhangs and door swings of parked vehicles.
6. Facilities should never obstruct the clear pedestrian thoroughway, curb ramps, or any accessible element of the streetside.
7. Place vertical elements so they provide the required lateral clearance to the face of the curb and satisfactory shoulder clearance from the clear pedestrian thoroughway zone.



Figure 8.3 Public art adds interest to a walking route. Source: Kimley-Horn and Associates, Inc.

Context Zones

The placement of streetside facilities should be focused in urban center (C-5) or urban core (C-6) context zones with predominantly retail- and entertainment-related ground floor uses with a main street level of pedestrian activity. The need for and benefits from facilities such as kiosks, restrooms, or small-scale retail stands is typically highest in C-5 and C-6 zones.

Facilities in the general urban (C-4) or suburban (C-3) context zones should be located at nodes of increased intensity of ground floor retail and entertainment uses that produce high levels of pedestrian activity. The provision of facilities at public transit transfer centers should be considered in all context zones.

Public Art

Pedestrian improvements create an opportunity to implement public art (**Figure 8.3**). On a large scale, public art has the ability to identify a district or contribute to a design theme. It can be an effective means

of encouraging pedestrian travel by adding interest to the route and creating community identity. The redesign of thoroughfares creates opportunities for the implementation of public art as part of an urban design or streetscape plan. This includes, but is not limited to artistically designed paving; design of furnishings, light fixtures, railings, or low walls; and sculptural objects, murals or other surface treatments. Placement of public art and monuments should not obstruct the driver's view of traffic control devices, be a distraction, or be located in a manner that could create a streetside hazard to motorists.

Design Guidance

Design guidance for the streetside elements of the thoroughfare is provided in the following sections. Specifically, design guidance is provided for streetside width and functional requirements, pedestrian buffers and edge and furnishings zone elements (trees and parkways, sidewalk crossings of driveways and alleys, utilities, street furniture and landscaping).

Streetside Width and Functional Requirements

Related Thoroughfare Design Elements

- Intersections.
- Edge, furnishings, throughway and frontage zone principles and considerations.
- Streetside facilities.
- Snow removal.
- Curb extensions.



Figure 8.4 A streetside with well defined zones. Source: Community, Design + Architecture.

Background and Purpose

The streetside, including the sidewalk, provides for the mobility of people and is an important social space where people interact and walk together, wait for transit, window shop, access adjoining uses, or have a cup of coffee at a street cafe. The streetside must be wide enough to accommodate movement as well as the important social functions related to the land uses located along the thoroughfare. The width and function of the streetside influence safety and help achieve accessibility. The optimal streetside width varies with the expected streetside activities, character of adjacent land uses and speed and volume of vehicular traffic in the thoroughfare.

General Principles and Considerations

General principles in the selection of appropriate streetside width include the following:

- The streetside should have well-defined zones so that the pedestrian throughway is clearly demarcated (**Figure 8.4**).
- Sidewalks should be provided on both sides of the street in urban contexts. In a small number of conditions, a sidewalk on only one side of the street is appropriate when unusual land uses, such as a canal, steep vertical wall, or railroad, exist and people do not have a need to access that side of the street.
- Care should be given where driveways and alleys cross sidewalks. At these locations there is a potential for conflict between drivers and pedestrians and an increased possibility that pedestrian

safety will be compromised. Crossings of driveways, garage accesses, alleys and such should maintain the elevation of the sidewalk and may be considered for special materials, colors, textures and markings alerting motorists that they are traversing a pedestrian zone.

- Utilities should not interfere with pedestrian circulation or block entrances to buildings or curb cuts or interfere with sight distance triangles.
- Space requirements for, and access to, transit facilities (such as bus shelters) should be included in the design of the streetside but must be outside of the clear pedestrian travel way.
- Sidewalks must provide convenient connections between building entries and transit facilities.
- Designers should coordinate with utility providers regarding the location of utility elements such as poles, cabinets, vaults, grates and manholes.
- Sidewalks should be as straight and direct as possible except to avoid mature trees or unavoidable obstacles. Pedestrians in urban and suburban contexts have a desire to walk a straight course.

Edge Zone Principles and Considerations

The edge zone, which is sometimes referred to as the “curb zone,” is the interface between the traveled way and the furnishing zone and provides an operational offset to:

Streetside Zones A Avenue, Lake Oswego, OR

A Avenue is classified as a major arterial thoroughfare located in a general urban context zone (C-4) in Lake Oswego's downtown central business district and civic center area. Downtown land uses consist of low to medium density commercial mixed use (office over retail/service) with low to medium density residential located one block from A Avenue. The ground floor uses are primarily commercial with a mix of retail, services and restaurants.

Although the streetside on A Avenue is narrow, it contains distinct zones for edge, furnishing, clear through-way and frontage. The edge zone is about 18 inches, allowing an operational clearance for opening car doors.

The furnishings zone (4–5 feet) contains street trees in wells with decorative grates, light standards, shrubs in moveable planters, seating and a collection of public art.

Underground utilities and vaults are also located in this zone. The clear throughway ranges from 5–8 feet and the frontage zone (about 2–3 feet) contains planters, window shopping areas and seating for outdoor cafes.



- Prevent vehicle overhangs from hitting vertical objects when turning or backing toward the curb;
- Provide clearance from tall vehicles that are parked next to the curbs on highly crowned pavements;
- Provide clearance for extended bus and truck mirrors; and
- Permit the opening of parked vehicle doors.

Other principles and considerations include:

- In compact mixed-use urban areas with on-street parking, particularly those areas with

ground floor retail activity, the edge zone should be a minimum of 1.5 feet to accommodate the door swing of a parallel parked car and prevent potential conflicts with elements in the furnishing zone. While this zone should generally be kept clear of any objects, parking meters can be placed here with consideration to door swings.

- The width of the edge zone adjacent to angled parking should account for the depth of vehicle overhang, which can vary between 1.5 and 2.5 feet depending on the angle of the parking spaces.



Figure 8.5 Utility poles and other fixtures should not interfere with the pedestrian thoroughway. This example shows a bus shelter and other street furniture properly located in the furnishings zone. Source: Kimley-Horn and Associates, Inc.

- If reverse (back-in) angled parking is considered, the edge zone lateral clearance must be at least 30 inches due to the added overhang of the rear of most vehicles.
- At transit stops with shelters, the edge zone should be widened to a minimum of 4 feet to provide wheelchair access to and in front of the shelter. A curb extension that stretches the length of the transit stop can also be an effective way to increase the width of the edge zone. Curb extension bus stops have additional advantages for transit operations, including faster passenger loading and unloading, more space for waiting passengers and less time for buses to re-enter the flow of traffic.

Furnishings Zone Principles and Considerations

The furnishings zone is the key buffer component between the active pedestrian walking area (throughway zone) and the thoroughfare traveled way. Principles

and considerations concerning furnishings zones include the following:

- Street trees, planting strips, street furniture, utility poles, signal poles, signal and electrical cabinets, telephones, traffic signal cabinets, signs, fire hydrants, bicycle racks and the like should be consolidated in this zone to keep them from becoming obstacles in the thoroughway zone.
- The furnishings zone accommodates curbside transit stops, including boarding areas, shelters and passenger queuing areas (**Figure 8.5**).
- When signal control cabinets, signal poles and other traffic equipment are installed, they must leave pedestrians in clear sight of, and in alignment with, motorist's views at all times. This might require special setbacks for oversized equipment.
- Retail kiosks, stands, or other business activities are appropriate in the furnishings zone (see earlier section in this chapter on streetside fa-

cilities and public art) if the furnishings zone is sufficiently wide to maintain a 1.5-foot minimum lateral clearance from the curb and overhanging parked vehicles.

- Installation of curb extensions (see the section in Chapter 10 on curb extensions) is an effective way to increase sidewalk space in the furnishings zone adjacent to crosswalks where pedestrians will wait before crossing the thoroughfare.
- Where no furnishings zone exists, elements that would normally be placed there, such as benches, light poles, signals, trash receptacles and so forth, may occupy the frontage zone to keep the clear pedestrian travel way unobstructed and comply with PROWAG requirements.

Throughway Zone Principles and Considerations

Principles and considerations concerning throughway zones include the following:

- Clear pedestrian throughway zones are intended for pedestrian travel only and should be entirely clear of obstacles and provide a smooth walking surface. According to PROWAG, running slopes should not exceed the grade of the adjacent street, and cross slopes should not exceed 2 percent, including across driveways.
- Width of the throughway zone should vary by context and the activity of the adjacent land use (**Table 8.1**).
- Recommended clear pedestrian throughway zone minimum width in constrained conditions is 5 feet in residential and 6 feet in commercial areas (see **Table 5.2** in Chapter 5).
- For very high pedestrian volume areas, such as subway exits, transit transfer points and assembly arena entrances and exits, additional width and special design attention, particularly at crossings, should be provided.
- Within the “station area” of high-capacity transit stations, sidewalks should be sufficiently wide to accommodate expected pedestrian volume surges and provide opportunities for faster pedestrians to overtake slower pedestrians.

Frontage Zone Principles and Considerations

The frontage zone is the area adjacent to the property line that may be defined by a building facade, landscaping, fence, or screened parking area. Principles and considerations concerning frontage zones include the following:

- Use the frontage zone to create pedestrian comfort. Generally, pedestrians do not feel comfortable moving at a full pace directly along a building facade or wall. The width of the frontage zone may vary to accommodate a variety of activities associated with adjacent uses, such as outdoor seating or merchant displays. In all cases, the 18 inches adjacent to a building wall should be considered minimum lateral or shoulder clearance for pedestrians. It should not be included as throughway zone width.
- Sidewalk businesses or other business activities should be conducted preferably in the frontage zone or, in some cases, the furnishings zone. Private furnishings permitted in the frontage zone may include seating and tables, portable signage and merchandise displays. These furnishings may require permits from the agency that owns the right of way.
- Overhanging elements such as awnings, store signage, bay windows and so forth may occupy this zone and extend over the clear pedestrian travel way. These elements add vitality and visual interest to the street but also must comply with local building codes and zoning ordinances. Overhanging elements require a vertical clearance of at least 80 inches.
- Where the streetside passes a parking lot, a buffer, such as a hedge or a low wall, should be used to prevent parked vehicles from overhanging into the frontage zone and to maintain an attractive frontage along the streetside. Where surface parking is exposed to a thoroughfare right of way, and a buffering hedge or low wall cannot be accommodated within the private property, the frontage zone should be widened to provide space for the hedge (2 to 3 feet) or low wall (0.5 to 1 foot) with a visual screen up to 6 feet in height.

Table 8.1 Recommended Streetside Zone Dimensions

Sidewalk Zone ^[1]	C-6 and C-5		C-4 w/ Predominantly Commercial Ground Floor Use		C-4 w/ Predominantly Residential Frontage		C-3 w/ Predominantly Commercial Ground Floor Use		C-3 w/ Predominantly Residential Frontage				
	1.5 feet 2.5 feet at diagonal parking	21.5 foot (recommended)	12 foot (constrained)	19 foot (recommended)	12 foot (constrained)	17.5 foot (recommended)	9 foot (constrained)	16 foot (recommended)	12 foot (constrained)	15.5 foot (recommended)			
Boulevard	Edge	1.5 feet 2.5 feet at diagonal parking	12 foot (constrained)	1.5 feet 2.5 feet at diagonal parking	1.5 feet	8 feet (landscape strip w/ trees and grasses or groundcovers)	1.5 feet	1.5 feet 2.5 feet at diagonal parking	1.5 feet	8 feet (landscape strip w/ trees and grasses, or groundcovers)	1.5 feet	9 foot (constrained)	15.5 foot (recommended)
	Furnishings	7 feet (trees in tree wells)	19 foot (recommended)	7 feet (trees in tree wells)	8 feet	0 feet along lawn and groundcover	8 feet	7 feet (trees in tree wells)	6 feet	0 feet along lawn and groundcover	6 feet	12 foot (constrained)	15.5 foot (recommended)
	Throughway	10 feet		8 feet	1 foot along low walls, fences and hedges	1.5 feet along facades, tall walls and fences	1.5 feet	1.5 feet	1.5 feet	1 foot along low walls, fences and hedges	1.5 feet along facades, tall walls and fences	12 foot (constrained)	9 foot (constrained)
	Frontage	3 feet		2.5 feet	1.5 feet along low walls, fences and hedges	1.5 feet along facades, tall walls and fences	1.5 feet	2.5 feet	1.5 feet	1 foot along low walls, fences and hedges	1.5 feet along facades, tall walls and fences	12 foot (constrained)	9 foot (constrained)
Avenue	Edge	1.5 feet 2.5 feet at diagonal parking	12.0 foot (constrained)	1.5 feet 2.5 feet at diagonal parking	1.5 feet	8 feet (landscape strip w/ trees and grasses or groundcovers)	1.5 feet	2.5 feet at diagonal parking	2.5 feet	8 feet (landscape strip w/ trees and grasses or groundcovers)	1.5 feet	12 foot (constrained)	15.5 foot (recommended)
	Furnishings	6 feet (trees in tree wells)	16 foot (recommended)	6 feet (trees in tree wells)	6 feet	0 feet along lawn and groundcover	6 feet	6 feet (trees in tree wells)	6 feet	0 feet along lawn and groundcover	6 feet	12 foot (constrained)	15.5 foot (recommended)
	Throughway	9 feet		6 feet	1 foot along low walls, fences and hedges	1.5 feet along facades, tall walls and fences	1.5 feet	2.5 feet	2.5 feet	1 foot along low walls, fences and hedges	1.5 feet along facades, tall walls and fences	12 foot (constrained)	9 foot (constrained)
	Frontage	3 feet		2.5 feet	1.5 feet along low walls, fences and hedges	1.5 feet along facades, tall walls and fences	1.5 feet	2.5 feet	2.5 feet	1 foot along low walls, fences and hedges	1.5 feet along facades, tall walls and fences	12 foot (constrained)	9 foot (constrained)
Street	Edge	1.5 feet 2.5 feet at diagonal parking	12.0 foot (constrained)	1.5 feet 2.5 feet at diagonal parking	1.5 feet	6 feet (landscape strip w/ trees and grasses or groundcovers)	1.5 feet	2.5 feet at diagonal parking	2.5 feet	6 feet (landscape strip w/ trees and grasses or groundcovers)	1.5 feet	12 foot (constrained)	12.5 foot (recommended)
	Furnishings	6 feet (trees in tree wells)	16 foot (recommended)	6 feet (trees in tree wells)	6 feet	0 feet along lawn and groundcover	6 feet	6 feet (trees in tree wells)	6 feet	0 feet along lawn and groundcover	6 feet	12 foot (constrained)	12.5 foot (recommended)
	Throughway	6 feet		6 feet	1 foot along low walls, fences and hedges	1.5 feet along facades, tall walls and fences	1.5 feet	2.5 feet	2.5 feet	1 foot along low walls, fences and hedges	1.5 feet along facades, tall walls and fences	12 foot (constrained)	9 foot (constrained)
	Frontage	2.5 feet		2.5 feet	1.5 feet along low walls, fences and hedges	1.5 feet along facades, tall walls and fences	1.5 feet	2.5 feet	2.5 feet	1 foot along low walls, fences and hedges	1.5 feet along facades, tall walls and fences	12 foot (constrained)	9 foot (constrained)

Notes: Recommended dimensions for the throughway zone may be wider in active commercial areas.

See Table 5.2 in Chapter 5 for discussion of minimum streetside zone widths in constrained conditions.

¹ In AASHTO's *Guide for the Planning, Design, and Operation of Pedestrian Facilities*, the furnishing zone is termed the "buffer" zone, and the frontage zone is termed the "shy distance."

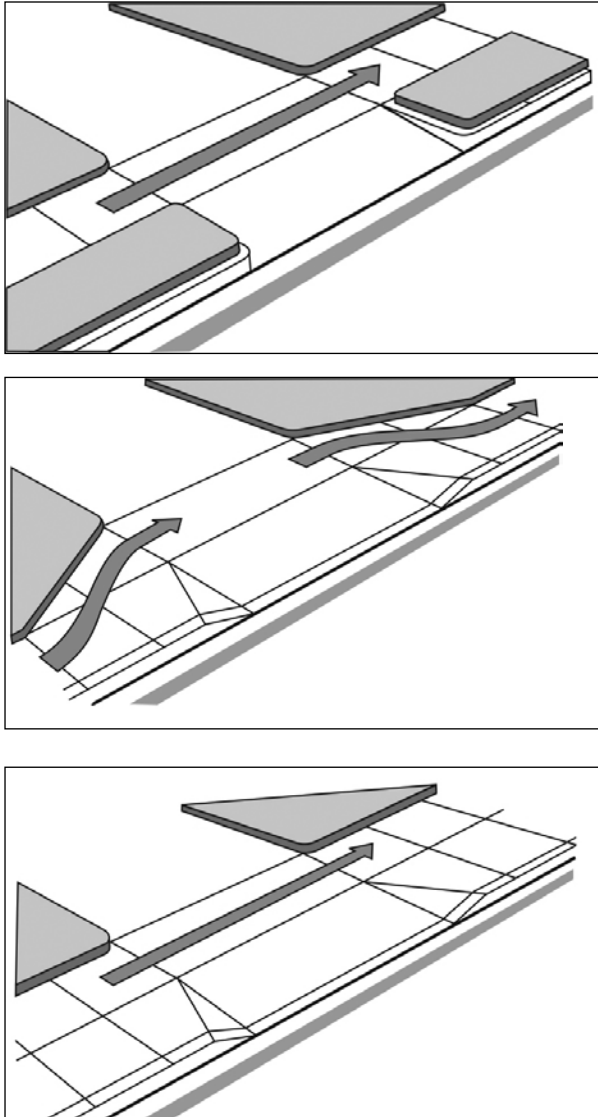

Figure 8.6 Preferred accessible designs for driveway and alley crossings. Source: based on *Designing Sidewalks and Trails for Access*. Illustration by Digital Media Productions.

Table 4.1 in Chapter 4 includes a discussion of context zones and frontage types.

Driveway Crossing Principles and Considerations

Principles and considerations concerning driveway crossings include the following:

- Appearance of the sidewalk (scoring pattern or special paving) should be maintained across driveway and alley access points to indicate that, although a

vehicle may cross, the area traversed by a vehicle remains part of the pedestrian travel way.

- It is desirable to minimize, consolidate, or eliminate curb cuts and driveways in areas of highest pedestrian activity such as urban center (C-5) and urban core (C-6) commercial areas. In these areas, driveway and curb cut frequencies and spacing should be kept to a practical minimum, ideally not more than one curb cut per block.
- Consolidation of driveways is particularly important in areas with predominantly commercial ground floor uses in suburban (C-3) and general urban (C-4) context zones.
- Driveway crossings should maintain the elevation of the sidewalk.
- Driveway aprons should not extend into the clear pedestrian travel zone, where cross slopes are limited to a maximum of 2 percent; steeper driveway slopes are permitted in the furnishing and edge zones of the streetside (see **Figure 8.6**).
- Along boulevards and avenues, the elimination of driveways and conflict points may be aided by the presence of continuous medians that restrict left turns.

Recommended Practice

Table 8.1 provides an overview of recommended width for each of the streetside zones described in this chapter. The table provides the recommended width of each of the zones by context zone, thoroughfare type and under varying predominant ground floor use conditions. **Table 8.1** also provides the total width of the streetside for a constrained condition.

Additional Guidelines

Driveway Crossings

- The width of driveways for two-way traffic should not exceed 24 feet unless a specific frequent design vehicle requires a wider dimension. Some driveway volumes warrant two lanes in each direction. In these cases, consider designing a median between directions to separate opposing traffic and to provide a pedestrian refuge.

When a driveway is one way only, a maximum width of 14 feet should be considered.

- In driveway or alley crossing locations, a minimum 5-foot-wide clear pedestrian throughway must be provided. **Figure 8.6** illustrates various designs under this minimum condition. The full pedestrian throughway is maintained across the entire driveway, and the slope does not exceed 2 percent. Note that the sidewalk remains level and the driveway apron does not extend into the sidewalk.

Utilities

- Aboveground utilities should be placed at least 18 inches from the back of curb and may not interfere with the minimum pedestrian throughway. If buildings do not abut the right of way, place utilities behind the sidewalk, where they will not interfere with the use of the adjacent property.
- Placing utilities underground avoids conflicts and clutter caused by poles and overhead wires and should be coordinated with street tree planting planning efforts to avoid conflicts between the trees and below-ground utilities and aboveground utility boxes. Placing utilities underground can be costly, particularly in retrofit situations.
- The design of sidewalks, planting strips, medians and other street elements must allow for service access to underground and overhead utilities.
- Longitudinal underground utility lines should be located in a uniform alignment as close to the right-of-way line as practical or within a planting strip. In urban areas with abutting buildings, locate utilities within the parking lane or planting strip.

Refer to AASHTO's *A Guide to Accommodating Utilities Within Highway Right-of-Way* (2005) for additional information on the design and placement of utilities.

Street Furniture

Street furniture placed along a sidewalk is an amenity that encourages walking. Street furniture—such as public telephones, seating, trash receptacles and

drinking fountains—provides both a functional service to pedestrians and visual detail and interest. Street furniture also conveys to other users of the thoroughfare that pedestrians are likely to be present. Guidelines include the following:

- Street furniture may be placed within curb extensions as long as it does not obstruct the clear pedestrian throughway, access to curb ramps, or sight distance at crossing locations. Bicycle parking or landscaped areas with seating walls can be accommodated in curb extensions.
- Street furniture should be placed on thoroughfares expected to have high pedestrian activity. When resources are limited, prioritize locations for the placement of street furniture. Examples of priority locations for street furniture include:
 - Transit stops;
 - Major building entries;
 - Retail and mixed-use main streets; and
 - Restaurants.
- Select the type, design and materials of street furniture to reflect the local character of the surrounding context and contribute to a sense of community identity.
- Ensure that placement of furniture does not reduce the width of the clear pedestrian throughway to less than 5 feet.

Landscaping

Landscaping is typically located in the furnishings zone of the streetside. Vegetation, especially trees, adds soft textures and bright colors to the concrete and asphalt surfaces of the thoroughfare and thereby increases comfort and distinguishes an area's identity. Landscaping also offers important ecological benefits. Trees are frequently the most visibly significant improvement, if properly selected, planted and maintained. They provide shade from the sun, intercept stormwater and buffer pedestrians from passing vehicle traffic. Guidelines include the following:

- Ground cover, grasses and shrubs might be appropriate supplements to add character along residential streets. Raised planters along mixed-use main streets can be used as seating and may increase pedestrian comfort by providing a visual buffer between pedestrians and traffic.



Figure 8.7 Street tree planted in curb extension in parking lane. Source: Kimley-Horn and Associates, Inc.

- Select plants that are adapted to the local climate and fit the character of the surrounding area.
- Consider the use of structural soils to allow for the planting of healthy street trees in narrow furnishing zones.
- Use street trees and other landscaping to complement street lighting and streetside facilities in creating a distinct character for specific streets, districts, or neighborhoods. Because lighting is an important aspect of thoroughfare safety, the practitioner needs to consider the effect of landscaping on the effectiveness of the lighting.
- If a continuous canopy of trees is desired by the community, space street trees between 15 and 30 feet on center, depending upon species, to

shade the streetside, define the edge of the street and buffer the streetside from the traveled way.

- Landscape plantings in urban center (C-5) and urban core (C-6) context zones may have a formal characteristic (in a more linear and symmetrical pattern), with plantings becoming less formal in less-intensive context zones (C-3 and C-4).
- In the more urban C-5 and C-6 context zones and along thoroughfare segments with predominantly commercial ground floor uses, trees should be planted in tree wells covered by tree grates to maximize the surface area for pedestrian circulation. Tree grates or landscaped cutouts should be considered for other context zones where commercial ground floor uses predominate.
- Prune trees so that branches do not interfere with pedestrians, street lighting, parked vehicles and sight distance to crossing pedestrians, as well as any traffic control devices. The minimum vertical clearance should be 8 feet above the pedestrian travel way in the streetside and at least

Utilities and Street Trees

Both overhead and underground utilities can pose conflicts with street trees.

Mature trees' branches may interfere with overhead wires and lead to "topping" by utility providers. This practice is unattractive and can be detrimental to the tree's branching structure. To avoid this situation, consider under-grounding utility lines or select shorter trees whose branches will remain below the utility lines.

When planning for street tree planting, identify and avoid any underground utilities that could be damaged during the installation process or tree roots.

Plan to "train" newly planted trees in the first years of growth to guide branch development and vertical clearance.

To avoid damage to utilities, sidewalks and pavement, encourage deep roots with use of watering tubes that allow water to seep into the soil below the roots.

Consider "root barriers," underground barriers enclosing roots, where there is potential for root damage.



Figure 8.8 A combination of on-street parking, furnishings zone and wide pedestrian throughway provides ample buffer from moving traffic. Source: Kimley-Horn and Associates, Inc.

13 feet from the top of curb in the traveled way to provide clearance for larger vehicles.

- On commercial streets with business signs, work with a landscape architect to select the appropriate types of tree and pruning techniques that minimize interference with sign visibility.
- Maintenance issues should be discussed in advance of the preparation of a streetscape improvement plan to ensure clear understanding of pruning and maintenance requirements.
- The width of the streetside landscaped strip should be at least 5 feet (preferred width is 8 feet) to support healthy tree growth.
- Trees can be planted in curb extensions between parking bays (**Figure 8.7**). This helps reduce the visual width of the street and can be part of a design that maintains a wider pedestrian throughway, especially in constrained conditions.

Pedestrian Buffer

The buffering of the streetside from vehicle traffic in the traveled way is one of the most important factors in providing pedestrian comfort along urban thoroughfares. The effectiveness of buffers is largely dependent on width (see the section in this chapter on streetside width and functional requirements) and the contributing buffer elements, such as street furniture and landscaping, that can create a visual and sound barrier between the pedestrian and moving traffic (**Figure 8.8**). On-street parking and edge and furnishings zones combine to provide buffering from traffic. Guidelines include:

- On-street parking should provide a buffer between pedestrians on the sidewalk and moving traffic; especially in areas with ground floor commercial uses and/or where high volumes of pedestrian activity are expected. Texturing parking lanes or bays with the same material as the sidewalk can visually reduce the width of the roadway when the parking lane is empty;

- For thoroughfares without on-street parking and travel speeds of 30 mph or less, the width of the furnishings zone as a buffer for pedestrians should be at least 6 feet wide;
- If necessary to achieve an appropriately wide pedestrian buffer within the furnishings zone, consider reducing the frontage zone to its minimum or eliminating it;
- Bicycle lanes can serve as a buffer if desired streetside widths cannot be achieved or if streetside widths can only be achieved at the lower end of the ranges shown in **Table 8.1**.

Justification

Although the recommendations in this chapter are generally consistent with the guidelines contained in the AASHTO *Guide for the Planning, Design and Operation of Pedestrian Facilities* (2004b), the recommendations for buffer widths in this chapter are wider than those recommended in the AASHTO guide.

Recommendations related to street furniture and landscaping in this chapter are based on recently published best practices, specifically the Santa Clara Valley (California) Transportation Authority's *Pedestrian Technical Guidelines* (2003), which describes the principles behind the use of street furniture and landscaping to encourage pedestrian activity.

The effect of on-street parking as a pedestrian buffer is generally recognized by practitioners as one factor in creating a comfortable pedestrian environment. Some pedestrian level of service methodologies place significant weight on the presence of on-street parking as a buffer for passing traffic.

Works Cited

American Association of State Highway and Transportation Officials. 1999. *Guide for the Development of Bicycle Facilities*. Washington, DC: AASHTO.

American Association of State Highway and Transportation Officials. 2002. *Roadside Design Guide*. Washington, DC: AASHTO.

American Association of State Highway and Transportation Officials. 2004a. *Policy on Geometric Design of Streets and Highways, Fifth Edition*. Washington, DC: AASHTO.

American Association of State Highway and Transportation Officials. 2004b. *Guide for the Planning, Design and Operation of Pedestrian Facilities*. Washington, DC: AASHTO.

American Association of State Highway and Transportation Officials. 2004c. *A Guide for Achieving Flexibility in Highway Design*. Washington, DC: AASHTO.

American Association of State Highway and Transportation Officials. 2005. *Accommodating Utilities Within Highway Right-of-Way*. Washington, DC: AASHTO.

Santa Clara Valley Transportation Authority. 2003. *Pedestrian Technical Guidelines*. San Jose, California: Santa Clara Valley Transportation Authority.

U.S. Access Board. 2005. *Public Rights-of-Way Accessibility Guide*. Public Rights-of-Way Access Advisory Committee (PROWAAC). *Special Report: Accessible Public Rights-of-Way: Planning and Designing for Alterations*. Washington, DC: U.S. Access Board.

Sources of Additional Information

City of Portland. 1998. *Pedestrian Design Guide*. Portland, OR: City of Portland, Oregon..

Transect Codeware Company. 2002. *Smart Code*. Duany Plater-Zyberk & Company. Version 2.6. Miami, FL: Transect Codeware Company.

Traveled Way Design Guidelines

Purpose

This chapter provides principles and guidance for the design of a thoroughfare's traveled way, which includes the elements between the curbs such as parking lanes, bicycle lanes, travel lanes and medians. The traveled way also includes midblock bus stops and midblock crosswalks. The guidance in this chapter is used in conjunction with the guidance for the other two thoroughfare components—the streetside (Chapter 8) and intersections (Chapter 10).

Objectives

This chapter:

1. Introduces and defines the elements of the traveled way;
2. Presents traveled way design considerations, including key factors in determining cross-sections;
3. Describes principles for transitioning urban thoroughfares when there is a change in context, thoroughfare type, or geometric elements; and

4. Provides design guidance for the primary elements of the traveled way, which are lane width, medians, bicycle lanes, on-street parking, geometric transition design, midblock crossings, pedestrian refuge islands, transit, bus stops and stormwater management.

Introduction

The traveled way comprises the central portion of the thoroughfare (**Figure 9.1**). It contains the design elements that allow for the movement of vehicles, transit, bicycles and freight. The traveled way is also where vehicles, via on-street parking, interface with the streetside. Many of the conflicts that occur on thoroughfares occur within the traveled way between two or more moving vehicles, moving and parking vehicles, bicyclists and vehicles, and vehicles and pedestrians crossing at midblock locations and intersections.

Fundamental principles of the design of this portion of the thoroughfare include uniform cross-section along the length of the thoroughfare and transitions designed to move vehicles laterally or change speed where cross-section elements change.

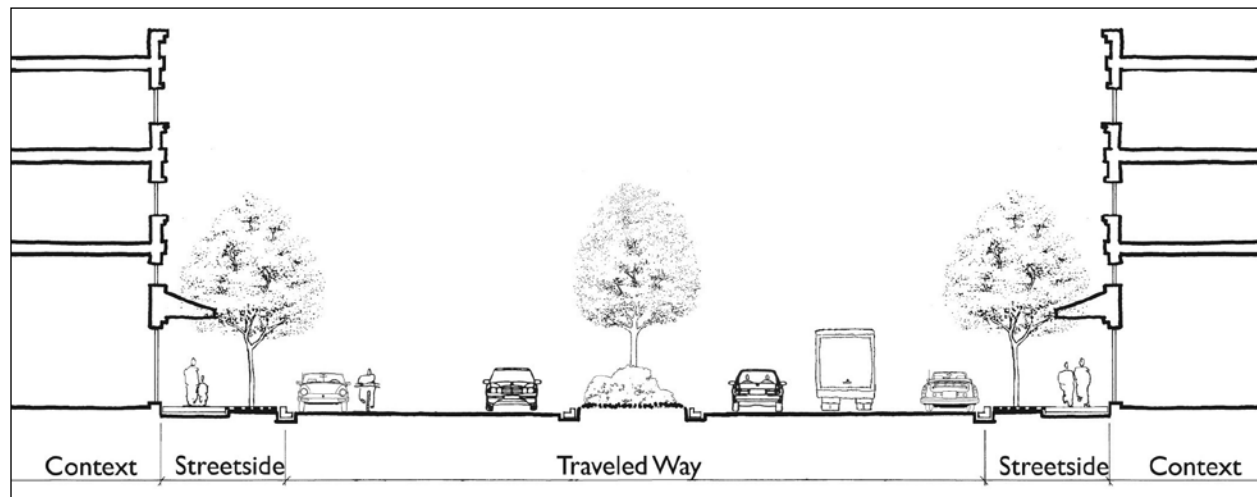

Figure 9.1 The traveled way is the component of the thoroughfare between the curbs. Source: Community, Design + Architecture.

This report addresses the following considerations for the thoroughfare traveled way:

- Cross-section determination;
- Access management;
- Emergency vehicle operations; and
- Transition principles.

This report addresses the following guidelines for the thoroughfare traveled way:

- Lane width;
- Medians;
- Bicycle facilities;
- On-street parking and configuration;
- Transition design;
- Midblock crosswalks;
- Pedestrian refuge islands;
- Transit design;
- Bus stops in the traveled way;
- Special consideration for stormwater management; and
- Special consideration for snow removal.

Design Considerations

Cross-Section Determination

The following design considerations are used to determine the optimum cross section:

1. Determine context zone and identify thoroughfare type based on **Tables 4.1** (Context Zone Characteristics), **4.2** (Thoroughfare Type Descriptions), **4.3** (Relationship Between Functional Classification and Thoroughfare Type), **4.4** (Urban Thoroughfare Characteristics), **6.4** (Design Parameters for Walkable Urban Thoroughfares) and **8.1** (Recommended Streetside Zone Dimensions). This establishes the general parameters for the cross-section (such as median width, parking lane width, streetside width and function).
2. Determine the preliminary number of lanes through a combination of community objectives, thoroughfare type, long-range transportation plans and corridor-wide and network capacity analysis. Network capacity (the ability of paral-

lel routes to accommodate travel demand) should influence the number of lanes on the thoroughfare. Thoroughfare in compact mixed-use urban areas are recommended to have a maximum of six through lanes where necessary because network connectivity is limited. A maximum of four lanes is recommended for new corridors.

3. Select the design and control vehicle for the thoroughfare by identifying the most common type of vehicle to accommodate without encroachment into opposing travel lanes. Chapter 7 describes the selection of a design and/or control vehicle and criteria for accepting encroachment of vehicles into opposing lanes.
4. Determine the preliminary number of turn lanes at critical intersections. Intersection design in CSS may require evaluation of trade-offs between vehicular capacity, level of service, pedestrian crossing distance and exposure to traffic.
5. Identify transit, freight and bicycle requirements for the thoroughfare and establish the appropriate widths for each design element.
6. Develop the most appropriate cross-section and compare the width to the available right of way:
 - If the cross section is wider than the right of way, identify whether right-of-way acquisition is necessary or whether design elements can be narrowed; and
 - If the cross section is narrower than the available right of way, determine which elements should be widened (such as the streetside) to utilize the available right of way.

Avoid combining minimal widths for adjacent elements, except on very low-speed facilities (25 mph maximum). For example, avoid combining minimal parking and bicycle lanes adjacent to minimum width travel lanes. Establish priorities for each mode and allocate the right-of-way width appropriately to that mode's design element. Use appropriate lane widths to accommodate the speed and design vehicle selected for the thoroughfare. Avoid maximum-width travel lanes if not warranted, as this creates overly wide thoroughfares that encourage high speeds.

Access Management

Access management is the practice of properly locating and designing access to adjoining properties to re-

duce conflicts and improve safety while maintaining reasonable property access and traffic flow on the public street system. Effective access management includes setting access policies for streets and abutting development, linking designs to these policies, having the access policies incorporated into legislation and having the legislation upheld in the courts.

Access management addresses the basic questions of when, where and how access should be provided or denied and what legal or institutional provisions are needed to enforce these decisions. It has been shown that good access management can reduce crashes by 50 percent or more, depending on the condition and treatment used (TRB 2003). The need for rigorous access management in compact urban areas can be lessened by proper network planning, because traffic distributed to a grid of streets reduces the concentration on any one thoroughfare.

The following principles define access management techniques:

- Classify the street system by function, context and thoroughfare type;
- Establish standards or regulations for intersection spacing (see Chapter 3 for guidance);
- On streets that serve an access function (the focus of this report), minimize curb cuts in urban areas to reduce conflicts between vehicles, pedestrians and bicyclists, locate driveways and major entrances away from intersections and away from each other to minimize effects on traffic operations, minimize potential for crashes, provide for adequate storage lengths for turning vehicles and reduce conflicts with pedestrians using the streetside;
- Use curbed medians and locate median openings to manage access and minimize conflicts; and
- Use cross streets and alleys to provide access to parking and loading areas behind buildings. This topic is discussed in Chapter 3 on network planning and in Chapter 8 on street-side design.

There are a number of resources listed at the end of this chapter that provide detailed guidance on access management.

Emergency Vehicle Operations

Urban thoroughfares are the primary conduits for emergency response vehicles, including police, fire and ambulance. Common design for thoroughfares encourages speed and capacity. This can lead to fatality- and injury-producing crashes. On the other hand, the emergency responder bears the responsibility for both response times and reasonable access to incidents within the community. A balance between these two interests must be established for the appropriate design of context sensitive thoroughfares. Both interests can work together to find response strategies that create safe and comfortable places for the non-motorist.

Emergency vehicle access and operations should always be considered in thoroughfare and site design. Local operational conditions will vary from place to place, and emergency response strategies are specific to the locale. Consequently, the practitioner should collaborate with emergency responders to learn their specific needs and response strategies and tactics used on similar streets. Asking the following questions will help in understanding issues when working with fire departments:

- What types of fire apparatus are used in responding to different emergencies that might occur on or adjacent to the thoroughfare?
- Does the type of vehicle change depending on where vehicles are responding (e.g., suburban residential versus urban core high rise)?
- In urban areas with tall buildings, how does the department deploy its ladders and how much width is needed between the vehicle and building? How much clear space is needed adjacent to the building? Do they require gaps in sidewalk furnishings to access buildings? Do they need to fully extend their vehicle's stabilizers?
- What are the characteristics of the apparatus that affect thoroughfare design (e.g., wheel turning path, overhang turning path, apparatus width)?
- In a block of attached multistory buildings, does the number of stories cause a difference in firefighting tactics that would affect the design of the adjacent street?

Fire codes may have additional guidance on emergency access requirements, such as minimum travel way clear widths and minimum space to deploy certain types of equipment, such as ladders, to reach high buildings. The following should be considered in designing networks and traveled ways to accommodate emergency vehicles:

- Many emergency responder concerns can be addressed at the network planning level. High levels of street connectivity improve emergency response by providing alternate routes, and can alleviate the need for passing stopped fire fighting vehicles. Measure network connectivity using metrics such as intersections per square mile. The threshold number of intersections per square mile should be somewhere around 150 (not including alleys). Other considerations are maximum block perimeter, existing or proposed thoroughfare connectivity and intersection types (cross, tee and so forth). A block perimeter of 1,140 feet is a reasonable length for pedestrians and emergency vehicles. Exceptions can be made, and the thoroughfare design practitioner and fire officials must come to a mutually acceptable decision based on specific local conditions.
- Alleys benefit emergency responders by creating a secondary means of approaching structure fires with smaller equipment. As secondary approaches, alleys are not primary access and need not be designed for the largest fire vehicle.
- In urban areas with tall buildings, consider no-parking zones or staging areas at the mid-block to accommodate large ladder trucks. The length and frequency of these zones should be determined with the emergency responder but should not be longer than 50 feet to minimize loss of on-street parking.
- When establishing new or reviewing existing access management configurations, care should be taken to permit direct routing capability for emergency vehicles.
- Use emergency vehicles as a design vehicle for the design of curb return radii only if the vehicle would use the roadway frequently (e.g., primary travel route from fire station to its service area). Otherwise, emergency vehicles

are generally able to encroach into opposing travel lanes. Consider using demonstration projects in the field to determine or confirm the optimal geometry for fire vehicles.

- On streets with medians or other access management features, emergency response time may be reduced by implementing mountable median curbs to allow emergency vehicles to cross (see **Figure 9.2**).
- Consider the use of bike lanes that are at least 6 feet wide on thoroughfares that have one lane in each direction and medians. This will provide the opportunity for vehicles to pull into the bike lane and allow emergency vehicles to pass them.
- Thoroughfare design in high-rise building environments may be constrained by the required distance between the building face and the centerline of ladder trucks. In many cases, this is 35 feet. However, this dimension varies and should be examined with fire officials.

Operational Considerations

Operational and technological strategies to enhance emergency vehicle response in urbanized areas include:

1. Reducing nonrecurring congestion using techniques such as traffic incident management and information, special events traffic management, work zone management and emergency management planning; and
2. Reducing recurring congestion using techniques such as freeway and arterial management, cor-



Figure 9.2 A mountable median allows emergency vehicles to access side streets. Source: Kimley-Horn and Associates, Inc.

ridor traffic management and travel demand management. These include techniques to improve day-to-day operations such as signal systems management, emergency vehicle preemption, access management, traveler information and intelligent transportation systems (ITS), which encompass many of the strategies listed in item 1 above.

Finally, it should be noted that firefighters are trained in many techniques that address context sensitive streets, mainly because narrow, low-speed, pedestrian oriented streets exist in many towns and cities. Many fire departments have experience with historic networks of narrow streets. Their experience provides a basis for allowing new neighborhoods to be built on networks of relatively narrow streets. The designer should be particularly sensitive to the local fire official's experience and operational needs on urban thoroughfares.

Transition Principles

Transitions refer to a change in thoroughfare type, context (rural to urban), right-of-way width, number of lanes, or neighborhood or district. For purposes of this report, transitions in the geometric design of thoroughfares refer to the provision of a smooth taper of appropriate length where lanes or shoulders change width, lanes diverge or merge, or lanes have been added or dropped.

In context sensitive thoroughfare design, however, transitions extend beyond geometric design requirements and reflect changes in context zone and associated levels of multimodal activity. As such, transitions can serve as a visual, operational and environmental cue of the following upcoming changes in:

- Functional emphasis from auto to pedestrian oriented;
- Thoroughfare type, particularly where functional classification and speed changes;
- Width of roadway, either a narrowing/widening of lanes or decrease/increase in number of lanes (see section on Geometric Transition Design later in this chapter); and
- Neighborhood or district, such as a transition between a commercial and residential district.

Principles for designing effective transitions include

- Using the established guidance—*Manual on Uniform Traffic Control Devices* (MUTCD), AASHTO Green Book—to properly design, mark and sign geometric transitions; and
- Designing transitions on a tangent section of roadway, avoiding areas with horizontal and vertical sight distance constraints. It is best if the entire transition length is visible to the driver.

If the purpose of the transition is to signal a change in context, neighborhood or district and/or change in speed zone, the transition principles include:

1. Providing a transition speed zone. The purpose of a transition speed zone is to avoid large reductions in the speed limit by providing two or more speed limit reductions. At a minimum, speed-reduction zones use regulatory speed limit signs. Speed limit reductions should occur on tangent sections distant from intersections. Changes in speed zones can utilize other traffic control devices such as warning signs, beacons and so forth as appropriate or can utilize appropriate traffic calming devices such as speed platforms or rumble strips where the zone is particularly short.
2. Providing visual cues to changes in context or environment. The intent of this principle is to combine regulatory speed change with traveled way or streetside features that influence driver speed. Visual cues can include streetside urban design features (landscaping, curbs, on-street parking, street light standards with banners, entry signs, thematic street furniture and so forth) and alternative pavement texture/material at intersections and crosswalks. Land uses and building style can provide visual cues as well. Progressively introducing taller buildings closer to the street affects driver perception of the change from rural or suburban to urban character. Vertical elements, such as street trees in which the vertical height is equal to or greater than the street width, may influence driver perception of the environment and indicate a change. Visual cues should culminate in a gateway at the boundary of the change in district, neighborhood, or thoroughfare. Gate-

ways (**Figure 9.3**) can be achieved with urban design features or unique intersections such as modern roundabouts.

3. Changing the overall curb to curb width of the street as appropriate for the context, thoroughfare type and traffic characteristics. This can apply to transitions where streets narrow from four to two lanes or widen from two to four lanes. Means of reducing overall street and traveled way pavement width include reducing the number of lanes, reducing lane widths, dropping through lanes as turning lanes at intersections, providing on-street parking or bicycle lanes, applying curb extensions at intersections and midblock crossings and providing a raised curbed median.

Design Guidance

Design guidance for the traveled way elements of the thoroughfare are provided in the following sections.

Lane Width

Background and Purpose

Street width is necessary to support desirable design elements in appropriate contexts, such as to provide adequate space for safe lateral positioning of vehicles, on-street parking, landscaped medians and bicycle lanes. Wide streets (greater than 60 feet), however, create



Figure 9.3 An arterial gateway into a downtown area composed of a raised intersection, public art, building orientation and attractive materials. Source: Kimley-Horn and Associates, Inc.

barriers for pedestrians and encourage higher vehicular speeds. Wide streets can reduce the level of pedestrian interchange that supports economic and community activity. Wide streets discourage crossings for transit connections. The overall width of the street affects the building height to width ratio, a vertical spatial definition that is an important visual design component of urban thoroughfares. Lane width is only one component of the overall width of the street but is often cited as the design element that most adversely affects pedestrian crossings. In fact, many factors affect pedestrian crossing safety and exposure, including the number of lanes, presence of pedestrian refuges, curb extensions, walking speed and conflicting traffic movements at intersections.

General Principles and Considerations

General principles and considerations in the selection of lane widths include the following considerations.

- Determine the overall width of the street and the traveled way on the accumulated width of the desired design elements (e.g., parking, bicycle lanes, travel lanes and median). Prioritize design elements that constitute an ideal cross-section and eliminate lower-priority elements when designing in constrained rights of way. Reducing lane width is one means of fitting the design into the available right of way.
- Curb lane widths should be measured to the face of curb unless the gutter and catch basin

Related Thoroughfare Design Elements

- Cross-section determination
- On street parking and configuration
- Access and speed management
- Bicycle lanes
- Bus stops
- Intersection layout
- Geometric transition
- Transit design

inlets do not accommodate bicycles and motor vehicles. However, to preserve available width for best use, inlets should be designed to safely accommodate bicycle and motor vehicle travel.

- Many fire districts require a minimum 20-foot-clear traveled way. This is usually not difficult to achieve on urban thoroughfares but could present challenges on thoroughfares that have one travel lane in each direction, on street parking and raised medians (the configuration of some four- to three-lane street conversions). In these circumstances consider adding bicycle lanes, mountable curbs on medians, median breaks, or flush cobblestone medians with periodic raised medians for plantings.
- Where adjacent lanes are unequal in width, the outside lane should be the wider lane to accommodate large vehicles and bicyclists (only where bicycle lanes are not practical), and facilitate the turning radius of large vehicles.
- While it may be advantageous to use minimum dimensions under certain circumstances, avoid combining minimum dimensions on adjacent elements to reduce street width where it could affect the safety of users. For example, avoid combining minimum-width travel lanes adjacent to a minimum-width parking/bicycle lane—a situation that reduces the separation between vehicles and bicyclists.
- When wider curb lanes are required, consider balancing the total width of the traveled way by narrowing turn lanes or medians to maintain the same overall pedestrian crossing width.
- Consider wider lanes along horizontal curves to accommodate vehicle off-tracking, based on a selected design vehicle. This measure is an alternative to increasing the curve's radius to accommodate off-tracking. The AASHTO Green Book provides guidance on widening for vehicle off-tracking.
- If a network evaluation determines that sufficient capacity exists to accommodate corridor- or areawide traffic demands, consider reducing the number of travel lanes to accommodate the desired design elements in constrained right of way. On streets with very

high turning movements, replacing through lanes (where turns are occurring from the inside through lane) with a turning lane can significantly improve traffic capacity.

- Where there is insufficient network travel lane capacity and right of way to meet thoroughfare design objectives, consider converting two parallel streets into a pair of one-way streets (couplet) to increase capacity before considering widening thoroughfares. While sometimes the subject of debate and controversy, one-way couplets have appropriate applications under the right circumstances. Strive to keep the number of lanes in each direction to three or less. This measure requires a comprehensive study of the ramifications for pedestrian and bicycle safety, transit and vehicle operations, economic issues and so forth. See the ITE *Traffic Engineering Handbook* for more on comparative advantages of one-way and two-way streets.

Recommended Practice

Select lane widths based on the following four key considerations:

- Target speed—on the lower-speed urban thoroughfares addressed in this report (target speeds of 35 mph or less), a range of lane widths from 10 to 12 feet on arterials and 10 to 11 feet on collectors is appropriate. On arterials with target speeds below 30 mph, widths in the lower end of the range are appropriate (10 to 11 feet). On collectors with a target speed below 30 mph, a 10-foot lane width may be appropriate unless the following design considerations or other factors warrant a wider lane. Turn lanes that are 10- to 11-foot wide are appropriate in urban areas with target speeds of 35 mph or less.
- Design vehicle—vehicles such as transit buses or large tractor-trailers require wider lanes, particularly in combination with higher design speeds if they frequently use the thoroughfare. Modern buses can be 10.5 feet wide from mirror to mirror and require a minimum 11-foot-wide lane on roadways with 30 to 35 mph target speeds. Wider curb lanes, between 13 to 15 feet

for short distances, should only be used to help buses negotiate bus stops and help trucks and buses negotiate right turns without encroaching into adjacent or opposing travel lanes.

- Right of way—balance the provision of the design elements of the thoroughfare with the available right of way. This balance can mean reducing the width of all elements or eliminating lower-priority elements.
- Width of adjacent bicycle and parking lanes—the width of adjacent bicycle and parking lanes influences the selection of lane width. If the adjacent bicycle or parking lane is narrower than recommended in this report, first consider widening the bicycle lane. If a design vehicle or target speed justifies such, provide a wider travel lane to provide better separation between lanes (**Figure 9.4**).

AASHTO highlights benefits of narrower (10 to 11 feet) travel lanes on lower-speed urban streets, including a reduction in pedestrian crossing distance, ability to provide more lanes in constrained rights of way and lower construction cost. The recommended travel lane widths in this report are also consistent with design guidelines in AASHTO's *Guide for Development of Bicycle Facilities* (1999) and the recommendations in *A Guide for Achieving Flexibility in Highway Design* (2004b).

Research on the relationship between lane width and traffic crashes found no statistically significant relationship between lane width and crash rate on arterial streets (TRB 1986).



Figure 9.4 Bike lanes on the Embarcadero in San Francisco. This multimodal boulevard along the waterfront was formerly an elevated freeway. Source: Dan Burden, walklive.org.

Medians

Background and Purpose

Medians are the center portion of a street that separates opposing directions of travel. Medians vary in width and purpose and can be raised with curbs or painted and flush with the pavement. Medians on low-speed urban thoroughfares are used for access management, accommodation of turning traffic, safety, pedestrian refuge, landscaping and lighting and utilities. Based on these functions, this guidance addresses raised curbed medians with a discussion of alternate applications such as flush medians interspersed with landscaped median islands.

In addition to their operational and safety functions, well-designed and landscaped medians can serve as a focal point of the street or an identifiable gateway into a community, neighborhood, or district. Medians can be used to create tree canopies over travel lanes, offer attractive landscaping and provide space for lighting and urban design features. Wider medians can provide pedestrian refuge at long intersection crossings and midblock crossings. Medians vary in width depending on available right of way and function. Because medians increase the width of a street, the designer must weigh the benefits of a median against the increase in pedestrian crossing distance and possible decrease in available streetside widths.

Operational and safety benefits of medians include storage for turning vehicles, enforcing turn restrictions, reducing conflicts, pedestrian refuge, snow storage, reducing certain types of crashes such as head-on colli-

Related Thoroughfare Design Elements

- Cross-section determination
- Access management
- Pedestrian refuge islands
- Intersection layout
- Lane width
- Transit design
- Midblock crossings

sions and space for vehicles crossing the thoroughfare at unsignalized intersections. With some innovation in design, curbed medians can provide biofiltration swales to retain and improve the quality of stormwater runoff.

Flexibility in median width design revolves around the median's function, appurtenances and landscaping to be accommodated in the median and available right of way. The designer needs to consider the trade-offs between the provision of a median and other design elements, particularly in constrained rights of way.

General Principles and Considerations

General principles and design considerations regarding medians include the following:

- Where medians are provided at intersections as refuge, they should be wide enough to accommodate groups of pedestrians, wheelchair users, bicyclists and people pushing strollers. To keep streets compact and pedestrian-scaled, median width typically should not exceed 18 feet in walkable urban environments except on ceremonial view corridors and parkways or where dual left turns are provided.
- On boulevards and wide avenues (more than 60 feet) where median dimensions need to remain continuous and left turn lanes are provided, medians should be 16–18 feet, to allow for a turn lane plus pedestrian refuge.
- Apply medians as part of a corridor access management strategy to improve safety and multimodal operational efficiency. Evaluate impacts on land access and ensure adequate locations for U-turns.

Median width may vary to accommodate a pedestrian refuge and/or turn lane. For example, designers may remove on-street parking near intersections in order to laterally shift the travel lanes to accommodate a median with a turn pocket. Where right of way is available, a continuous dimension for the median is preferred.

- Use an appropriate design vehicle for left- and U-turns when designing median width (see **Chapter 7**).
- Avoid providing overly wide medians at the expense of unreasonably narrowing the streetside. In walkable urban contexts, streetsides of appropriate width

should take higher priority than wide medians. However, the design needs to balance the safety, operational and pedestrian comfort needs of the street.

- In contrast to medians in rural areas, the width of medians at intersections in urban areas should only be as wide as necessary to provide the desired function (accommodation of longitudinal left turns, pedestrian refuge and so forth). Otherwise, the intersection loses operation efficiency and vehicles crossing the median may use the width inappropriately (side-by-side queuing, angled stopping and so forth).
- On multilane thoroughfares, medians aid pedestrians in their crossing. A median of 6 to 8 feet can be more desirable to a crossing pedestrian than the same width added to another element of the thoroughfare.
- If the median will not be landscaped, consider using alternative contrasting materials to create visual interest and an aesthetic appearance.
- Raised medians in low-speed urban contexts should be constructed with vertical curbs to provide refuge for pedestrians, access management and a place to install signs, utilities and landscaping. In snow conditions, raised medians improve delineation of the median. If emergency access is a concern, mountable curbs should be considered in special locations (where medians are carried across intersections, access managed thoroughfares near fire stations, or within 200 to 300 feet of an intersection approach that frequently experiences long queues). Mountable medians can be super-reinforced with grass-concrete pavers or concrete with added rebar.
- Narrow medians (4 feet or less) should only be used to restrict turning movements, to separate opposing directions of traffic and to provide space for traffic control devices (**Figure 9.5**). A 4-foot median may also be landscaped with shrubs.

In constrained rights of way, consider narrower medians with attractive hardscape and urban design features in lieu of planting, or provide a discontinuous median as right of way permits.

Where flush medians are desirable to maintain access to fronting property (e.g., suburban commercial

corridors), consider using textured or colored paving or stamped concrete for the median lane interspersed with raised landscaped islands to channelize turning traffic, divide opposing lanes of traffic and provide pedestrian refuge where appropriate (such as midblock and intersection crossings).

Landscaping on medians should be designed in a manner that does not obstruct sight-distance triangles.

Recommended Practice

Table 9.1 presents the recommended practice for median widths for various functions within low-speed thoroughfares (35 mph or less). The recommendations assume arterial and collector streets in urban contexts (C-3 to C-6) with operating speeds of 35 mph or less. Most of the guidance in this report is not applicable to flush or depressed medians or to raised medians with mountable curbs. Note that median widths are measured from face of curb to face of curb.

Additional Guidelines

Additional guidelines regarding medians also include the following:

- At lower urban speeds (25 to 30 mph) there is no need to provide an offset between the median curb face and the travel lane;



Figure 9.5 Narrow medians, such as on this boulevard in Chicago, should only be used to restrict turning movements, separate opposing traffic and create space for traffic control devices. Source: The Congress for the New Urbanism.

- Pave inside travel lane up to the face of the median curb unless a gutter pan is required for drainage; use 6-inch to 1-foot gutter pans unless typical flow requires more; avoid placement of catch basins in median gutters;
- Design the median nose using state, local, or AASHTO guidelines, ensuring proper end treatments to guide vehicles away from the median and pedestrian refuges;
- Design median turn lanes, tapers and transitions using state, local, or AASHTO guidelines for intersection design; and
- At intersection crossings, where the median is wide enough (see **Table 9.1**), extend the median nose beyond the crosswalk to provide an enclosed pedestrian refuge (**Figure 9.6**).

Trees and Landscaping in Medians

In urban areas, the community may find it desirable to plant trees in raised curbed medians for aesthetic purposes. In general, the guidance in this report is consistent with AASHTO in regards to low-speed urban thoroughfares. Additional information and mitigative strategies on trees within the public right of way may be found in *A Guide for Addressing Collisions with Trees in Hazardous Locations* (TRB 2003). General guidelines for median trees include the following:



Figure 9.6 Median nose extended beyond the crosswalk to provide an enclosed pedestrian refuge. Source: Kimley-Horn and Associates, Inc.

Table 9.1 Recommended Median Widths on Low Speed Walkable Thoroughfares (35 mph or less)

Thoroughfare Type	Minimum Width	Recommended Width
Median for access control		
All thoroughfare types	4 feet	6 feet ¹
Median for pedestrian refuge		
All thoroughfare types	6 feet	8 feet
Median for street trees and lighting		
All thoroughfare types	6 feet ²	10 feet ³
Median for single left-turn lane		
Collector avenues and streets	10 feet ⁴	14 feet
Arterial boulevards and avenues	12 feet	16–18 feet
Median for dual left-turn lane		
Arterial boulevards and avenues	20 feet	22 feet
Median for transitway		
Dedicated rail or transit lanes	22 feet	22–24 feet
Added median width for platforms	10 feet for each side platform 30 feet for center platform	

¹ A 6-foot-wide median is the minimum width for providing a pedestrian refuge.

² Six feet (measured between curb faces) is generally considered a minimum width for proper growth of small trees less than 4 inches in diameter at maturity. A 10-foot median is recommended for larger trees.

³ Wider medians to provide generous landscaping are acceptable, if desired by the community. However, avoid designing medians wider than necessary to support its desired function at intersections. This can reduce the operational efficiency of the intersections and invite undesirable behavior of crossing traffic such as side-by-side queues, angled stopping and so forth.

⁴ A 10-foot wide median allows for a striped left-turn lane (9 to 10 feet wide) without a median nose.

- Small-caliper trees can be healthy in medians that are at least 6 feet wide, as long as a critical root area is provided. A 10-foot-wide median is recommended for larger trees. Consult an urban forester for guidance on health requirements for trees in medians. Consider the safety issues of large-caliper trees.
- Maintain a horizontal offset (minimum of 18 inches) between the trunk and median curb face and prune to maintain sight distance (**Figure 9.7**).
- Trees closer than 50 feet from the ends of medians must be regularly pruned to maintain sight distance. Trees should always be located and maintained so that the motorists' clear vision of any traffic control signs or signals will be assured at all times, retaining a vertical clearance between 2.5 feet (or 3 feet from pavement surface) and 8 feet from the top of the curb.



Figure 9.7 Maintain a minimum 18-inch offset between the face of median tree (at maturity) and the face of curb. Source: Dan Burden, walklive.org.

Example Landscape Setbacks from Utilities

Overhead electric—10, 15, or 20 feet, depending on tree height

Sanitary sewer main—15 feet all tree species

Water main—10, 15, or 20 feet, depending on tree size

Fire hydrant—5 feet all landscaping, 10 feet all trees

Water meter—5 feet all landscaping, 10 feet all trees

Gas lines—5, 10, or 15 feet, depending on tree size

Underground electric—5, 10, or 15 feet, depending on tree size

Street lights—10 feet all trees

Electric transformers—10 feet front access, 5 feet other sides—all landscaping

Switch cabinet—10 feet front and back access, 5 feet other sides.

Source: Gainesville, FL, *Regional Utilities Vegetation Management Tree Planting Guidelines*

- Should the community desire a continuous canopy of trees in the median, space trees between 15 and 30 feet on center, depending upon species.
- Branches that extend beyond the curb into the travel lane should be pruned to a minimum height of 13 feet above the pavement.
- Plan tree spacing and canopy height along with other elements such as light standard spacing and height, utility placement and height and traffic control devices to minimize interference and provide adequate lighting and sight lines when trees are mature. Contact local utility providers to ensure compliance with required setbacks (see sidebar for an example of setback requirements).
- When hardscape is used between median trees, structural cells (modular, preengineered cell systems designed for water management, soil and tree roots), supported reinforced panels, or other methods should be used to promote healthy roots under the hardscape.

- To maintain healthy median landscaping, an adequate watering and drainage system needs to be provided. Drought-tolerant plantings should be used when an irrigation system is not available. Provide underdraining when needed for soil conditions.

Landscaping and trees in medians are strongly encouraged in context sensitive design, not only for aesthetics but also for shade, heat island reduction and storm-water interception. The use of medians for pedestrian refuge is recommended to reduce the pedestrian barriers created by wide urban arterials and to support safe design of midblock crossings. As refuges, medians allow pedestrians to focus on crossing one direction of the street at a time, therefore reducing conflicts and decisions. At intersections, pedestrian refuges assist all pedestrians, especially the elderly, to safely cross streets (**Figure 9.8**).

Some agencies require the use of crash tested barriers when large trees are planted in narrow medians. Consult with the agency on aesthetic treatment of such barriers.

Justification

The same rationale for medians on rural highways and conventional urban streets can be applied to context-based design of urban thoroughfares—to provide traffic safety and operational benefits by separating traffic flows, reducing conflicts and creating



Figure 9.8 This boulevard median serves as a pedestrian refuge, a community gateway and area for landscaping. Source: Kimley-Horn and Associates, Inc.

space for turning vehicles and utilities in the center of the street. In the design of walkable urban streets, the use of medians for traffic safety and operations remains a primary objective but is expanded to emphasize the median's role as an aesthetic amenity to the street and community and to provide pedestrian refuge on wider street crossings.

Bicycle Lanes

Background and Purpose

Bicycle travel should be served on multimodal streets. Bicyclists vary in their level of skill and confidence, trip purpose and preference for facility types; thus, the mobility needs of bicyclists in urban contexts vary as well. Bicycle facilities should encompass a system of interconnected routes, paths and on-street bicycle lanes that provide for safe and efficient bicycle travel. This report focuses only on the provision of bicycle lanes on major thoroughfares— streets that are designated as arterials or collectors. Refer to AASHTO's *Guide for the Development of Bicycle Facilities* for planning and design guidance for other types of bicycle facilities.

Not all urban thoroughfares will include bicycle lanes. However, except for freeways and streets where bicycling is specifically prohibited, bicyclists are permitted to use any street for travel, even if bicycle lanes are not provided. The design of bicycle lanes on major urban thoroughfares is typically



Figure 9.9 A bike lane adjacent to parallel parking on an avenue. Source: Kimley-Horn and Associates, Inc.

coordinated with a community's or region's master bicycle plan to ensure overall connectivity and the selection of the best streets for implementation of bicycle lanes. However, absence of a designation in a bicycle plan does not exclude the practitioner from providing bicycle lanes if the need exists. The width of the street and the speed and volume of adjacent traffic are the most critical factors in providing safe bicycle lanes. If adequate facilities cannot be provided, then the safety of both the bicyclist and driver is compromised. In urban areas the practitioner is faced with two conditions in designing bicycle lanes: adjacent to curb or adjacent to on-street parking (**Figure 9.9**). This section addresses these conditions.

Related Thoroughfare Design Elements

- Cross-section determination
- Lane width
- Bicycle lane treatment at intersections
- On-street parking and configuration
- Transit design
- Modern roundabouts
- Curb extensions

General Principles and Considerations

Implementation of bicycle lanes can meet many community objectives, including accessibility, connectivity between destinations, youth mobility and increased system capacity. General principles and considerations regarding bicycle lanes include the following:

- Bicycle lanes are not required on every street. It is desirable to provide bicycle lanes on major thoroughfares with target speeds of 30 mph or more and on streets with high traffic volumes and speeds less than 30 mph.

- Availability of parallel bicycle facilities does not eliminate the need to have a bicycle lane on thoroughfares. Bicyclists need to access properties along corridors, and they often benefit from traffic signals and other controls found on urban thoroughfares.
- The decision to place bicycle lanes on major urban thoroughfares should be based upon a number of factors, including:
 - Interconnectivity between other bicycle facilities and direct connections between origins and destinations, including transit access points; and
 - Ability to provide a continuous facility and overcome barriers such as topography, rivers, railroads, freeways and so forth.
- As published in *Selecting Roadway Design Treatments to Accommodate Bicyclists* (FHWA, 1994), a “design bicyclist” refers to the skill level of the bicyclist and, along with the factors described above, affects decisions on implementation of bicycle lanes. The three types of bicyclists, each of which has different needs, are (1) advanced or experienced bicyclists (require facilities for directness and speed and are comfortable riding in traffic and shared lanes), (2) basic or casual bicyclists (require comfortable and direct routes on lower-speed and lower-volume thoroughfares and prefer separated and delineated bicycle facilities), and (3) children (require adult supervision and typically only travel on separated paths or very low-volume and low-speed residential streets).
- Walkable urban thoroughfares should at least meet the needs of type 2, the basic or casual bicyclists.
- When considering additional operating space in urban areas, it is a constant challenge to balance competing needs on multimodal thoroughfares. Nowhere is this more evident than in providing bicycle facilities. As stated in the Chapter 9 section on lane width, avoid combining minimum dimensions to implement all of the desirable design elements, particularly on designated bicycle routes.
- It is often more prudent to provide the recommended or maximum dimensions for bicycle

facilities, curb lanes and parking lanes and to eliminate other design elements to maximize bicyclist safety. For example it may be desirable to convert a four-lane undivided street to a three-lane street with left-turn lanes to provide bicycle lanes rather than narrowing all of the other design elements to retain four lanes.

- Designated bicycle facilities adjacent to head-in angled parking are discouraged because of the lack of visibility between bicyclists and drivers backing out of spaces. Converting from angled to parallel parking provides width for bicycle lanes.
- Where possible on one-way streets, angled parking can be implemented on the left side of the street while the bicycle lane remains adjacent to parallel parking on the right side of the street. Some communities use reverse (back-in) angled parking, which improves driver visibility of bicyclists (**Figure 9.10**).
- Bicycle travel on sidewalks should be discouraged, even if the sidewalk width meets the width requirements of a shared multi-use path. Bicycles on sidewalks travel at higher speeds than pedestrians, creating the potential for serious injury. Bicyclists might collide with obstacles on sidewalks including street furniture, sign posts and so forth. Additionally, drivers do not expect bicyclists on sidewalks, creating conflicts at intersections and driveways. Con-



Figure 9.10 Reverse (back-in) angled parking improves driver visibility of bicyclists. Source: Dan Burden, walklive.org.

Table 9.2 Recommended Practice for Bicycle Lanes on Walkable Urban Thoroughfares

	Minimum Width	Recommended Width
Bicycle lane width—combined with on-street parking lane		
All thoroughfare types	13 feet	13 feet
Bicycle lane width—no on-street parking		
All thoroughfare types	5 feet ¹	6 feet

Table notes:

¹ Requires a minimum 3-foot rideable surface outside of gutter pan. If no gutter pan is present, the minimum width is 5 feet. Bicycle routes without marked lanes are acceptable for low-volume thoroughfares with target speeds of 25 mph or less.

venient alternatives will limit the attractiveness of sidewalk riding. While on-street facilities designed to the guidelines above are preferred, alternative routes on parallel streets or a separated off-street multi-use path may be a better choice in some situations.

The design of bicycle lanes in urban areas is well documented. Refer to the *Manual on Uniform Traffic Control Devices* (FHWA 2009) and *Guide for the Development of Bicycle Facilities* (AASHTO 1999). For alternative ways to accommodate bicyclists refer to *Innovative Bicycle Treatments* (ITE 2002).

Recommended Practice

Table 9.2 presents the recommended practice for bicycle facilities on thoroughfares. The recommendations assume arterial and collector streets in urban contexts with target speeds of 35 mph or less.

Justification

Urban thoroughfares within the bicycle network should provide bicycle lanes, particularly where the width of shared lanes is prohibitive or undesirable. The type and experience level of bicycle riders and the volume of bicyclists is a consideration in determin-

ing the need for bicycle lanes. Where bicycle lanes are needed and right of way is constrained, the designer needs to understand the trade-offs between adding bicycle lanes and eliminating or reducing the width of other thoroughfare design elements.

On-Street Parking Configuration and Width

Background and Purpose

The presence and availability of on-street parking serves several critical needs on urban thoroughfares: to meet parking needs of adjacent uses, protect pedestrians from moving traffic and increase activity on the street. Usually, on-street parking cannot by itself meet all of the parking demand created by adjacent land uses and typically will supplement the off-street parking supply. On-street parking provides the following benefits:

- Supports local economic activity of merchants by providing proximate access to local uses, as well as visitor needs in residential areas;
- Increases pedestrian comfort by providing a buffer between pedestrians and moving traffic helping reduce vehicle splash, noise and fumes;
- Slows traffic, making pedestrian crossing safer;

- Enables drivers and their passengers to become pedestrians conveniently and safely;
 - Provides an indication to the motorist that desired operating speeds are reduced and that they are entering a low or moderate travel speed area;
 - Provides the shortest accessible route to a street fronting building entrance for pedestrians who have disabilities;
 - Increases pedestrian activity on the street since people will walk between their parking space and destination, providing more exposure to ground floor retail and increasing opportunities for social interactions;
 - Supports local economic activity by increasing the visibility of storefronts and signs to motorists parking on street;
 - Reduces development costs for small business by decreasing on-site parking needs, particularly in urban infill development on small lots;
 - Requires less land per space than off-street parking and is thereby an efficient and cost-effective way to provide parking; and
 - Provides space for on-street loading and unloading of trucks, increasing the economic activity of the street and supporting commercial retail uses.
- A reduction in traffic capacity and increased friction in the flow of traffic;
 - Conflicts with the provision of bicycle lanes and increased hazards to bicyclists;
 - Use of thoroughfare width that could be used for other functions (e.g., wider streetsides);
 - Visual obstructions for pedestrians crossing intersections, vehicles moving along the thoroughfare and vehicles exiting driveways;
 - The need for, and administration of, parking enforcement; and
 - An increase in crashes.

On-street parking can result in a 3 to 30 percent decrease in the capacity of the adjacent travel lane, depending on the number of lanes and frequency of parking maneuvers. The designer needs to balance traffic capacity and local access needs when deciding where and when to permit on-street parking. There are methods for minimizing the impact of parking maneuvers on traffic flow. For example, see MUTCD (Figure 3B–17, referenced in Section 3B.18) showing a parallel parking configuration that allows vehicles to drive forward into the parking space.

General Principles and Considerations

General principles and considerations regarding on-street parking include the following:

- On-street parking should be located based on the characteristics of the thoroughfare type, needs of the adjacent land uses and applicable local policies and plans for parking management.
- On-street parking should be primarily parallel parking on higher-volume urban arterial boulevards and avenues. Angled parking may be used on low-speed and low-volume collector avenues and streets with ground floor commercial uses, primarily those serving as main streets (see **Figure 9.11** and the Chapter 6 section on special thoroughfare types).
- On-street parking should be prohibited on streets with speeds greater than 35 mph due

Related Thoroughfare Design Elements

- Lane width
- Curb extensions
- Bicycle lanes
- Cross-section determination

Trade-Offs

While this report supports on-street parking as an inherent element of walkable, compact, mixed-use urban areas and a component of the economic health of urban businesses, the practitioner designing walkable streets should always consider the trade-offs of integrating on-street parking. These include:

to potential hazards associated with maneuvering in and out of spaces.

- Width of the parking space is dependent on the context zone, thoroughfare type and the anticipated frequency of parking turnover.
- Conform to local and PROWAG accessibility requirements and provide appropriate number of accessible spaces.
- Use metered parking, or a similarly appropriate technology, to enforce parking time limits that provide reasonable short-term parking for retail customers and visitors while discouraging long-term parking.
- In developing and redeveloping areas, provide the amount of on-street parking for planned, rather than existing, land use densities. If more parking is needed, consider public or shared parking structures or integrate the design of parking facilities with adjacent land uses.

Recommended Practice

The preferred width of a parallel on-street parking lane is 8 feet wide on commercial thoroughfares (all types) or where there is an anticipated high turnover of parking and 7 feet wide on residential thoroughfares. These dimensions are inclusive of the gutter pan and applicable to all context zones (C-3 through C-6).



Figure 9.11 Angled parking on a retail-oriented main street in Hayward, CA. Source: Kimley-Horn and Associates, Inc.

On low-volume, low-speed avenues and streets in commercial main street areas, where sufficient curb-to-curb width is available, angled parking may be appropriate. Angled parking should have the dimensions shown in **Table 9.3** for a variety of different angles. Head-in angled parking can create sight distance problems associated with vehicles backing out of parking spaces. The use of reverse (back-in) angled parking can be used to overcome sight distance concerns and is considered safer for bicyclists traveling adjacent to angled parking (**Figure 9.12**).

Table 9.3 Minimum Dimensions for Head-In Angled On-Street Parking*

Angle	Stall Width	Stall Depth (Perpendicular to Curb)	Min. Width of Adjacent Lane	Curb Overhang
45°	8.5–9.0 feet	17 feet 8 inches	12 feet 8 inches	1 foot 9 inches
50°	8.5–9.0 feet	18 feet 3 inches	13 feet 3 inches	1 foot 11 inches
55°	8.5–9.0 feet	18 feet 8 inches	13 feet 8 inches	2 feet 1 inches
60°	8.5–9.0 feet	19 feet 0 inches	14 feet 6 inches	2 feet 2 inches
65°	8.5–9.0 feet	19 feet 2 inches	15 feet 5 inches	2 feet 3 inches
70°	8.5–9.0 feet	19 feet 3 inches	16 feet 6 inches	2 feet 4 inches
90°	8.5–9.0 feet	18 feet 0 inches	24 feet 0 inches	2 feet 6 inches

Source: *Dimensions of Parking*, 4th Edition, Urban Land Institute

Notes:

Typical design vehicle dimensions: 6 feet 7 inches by 17 feet 0 inches. Use 9.0 feet wide stall in commercial areas with moderate to high parking turnover.

*For back-in angled parking, reduce curb overhang by one foot.



Figure 9.12 Reverse (back-in) angled parking improves driver visibility. Source: Dan Burden, walklive.org.

Additional Guidelines

Additional guidelines regarding on-street parking include the following:

- Where traffic capacity needs to be balanced with on-street parking, consider using the curb lane for parking during off-peak periods and for traffic during peak periods. It is important to consider the trade-offs of this strategy. It requires consistent daily enforcement and immediate towing of violators. Removal of parking will impact the walkability of the streetside by removing the parking buffer. This strategy should be used when traffic congestion causes significant impacts to adjacent residential neighborhoods or in conditions with poorly connected networks and limited alternative routes.
- Angled parking should be allowed in C-4 and C-5 context zones where operating speeds are 25 mph or less and where the community finds the delay produced by parking maneuvers acceptable. Where practical or on bicycle routes, back-in diagonal parking is preferable to front-in parking. Consider the trade-offs associated with different angles of parking; lower-angle parking results in fewer parking spaces, while higher-angle parking requires a wider adjacent travel lane to keep vehicles exiting parking spaces from backing into the opposing travel lane.
- For parallel parking provide a minimum 1.5-foot wide operational offset between the face of curb and edge of potential obstructions

such as trees and poles. This will allow the unobstructed opening of car doors.

- Parking should be prohibited within 10 feet of either side of fire hydrants (or per local code), at least 20 feet from nearside of midblock crosswalks (those without curb extensions) and at least 20 feet from the curb return of intersections (30 feet from an approach to a signalized intersection) unless curb extensions are provided (see Chapter 10).
- At bus stops, intersections and various mid-block locations, extend curbs by 6 feet into the parking lane to improve pedestrian visibility and to provide additional space for street furniture and landscaping (see Chapter 10 section on curb extensions).
- Reverse (back-in) angled parking requires a wider edge zone in the streetside due to the longer overhang at the rear of most vehicles. This extra width can be compensated by the narrower travel lane needed adjacent to parking for maneuvering and less depth for the parking stall since the longer overhang is over the curb.

Justification

The recommendations in this report are based on the principles presented in the AASHTO Green Book and pedestrian facilities guide. The Green Book states that the “designer should consider on-street parking so that the proposed street or highway improvement will be compatible with the land use ... the type of on-street parking should depend on the specific function and width of the street, the adjacent land use, traffic volume, as well as existing and anticipated traffic operations.”

Geometric Transition Design

Background and Purpose

Transitions refer to a change in the width or speed of a thoroughfare or the need to laterally shift vehicles. In terms of geometric design, transitions refer to the provision of an adequate taper where lanes shift or narrow, shoulders widen, lanes diverge or merge and where deceleration lanes are provided. Geometric transitions are usually required when there is a change in the thoroughfare type and associated change in width, particularly

where functional classification and speed changes and where a change in the width of roadway, either a narrowing or widening of lanes, or a decrease or increase in number of lanes is introduced. Refer to the section transition principles earlier in this chapter for guidance on nongeometric transitions.

Recommended Practice

For changes in roadway width and space designing a geometric transition such as a lateral shift, lane addition or drop, lane or shoulder narrowing and so forth, use the established guidance in the MUTCD, where the length of the transition taper is computed by the following equation:

- $L = WS^2/60$ (for speeds less than 45 mph)

where L equals the length of the transition taper (feet), W equals the width of the lateral shift or offset (feet) and S equals the 85th percentile operating speed in mph or posted speed in mph (whichever is higher) or the target speed in new construction projects (Figure 9.13).

Additional Guidelines

- Transitions should be accompanied by appropriate warning signs (refer to MUTCD).
- Transitions should occur on a tangent section of roadway, avoiding areas with horizontal and vertical sight distance constraints.
- Ensure the entire transition length is visible to the driver.
- The transition design described above is unnecessary when roadways widen or lanes are added. In these cases, a transition taper of 10 to 1 is sufficient. Speed-change lanes at intersections (transitions to left- or right-turn lanes) usually require a shorter taper and deceleration distance. AASHTO recommends 100 feet for single-turn lanes and 150 feet for dual-turn lanes.

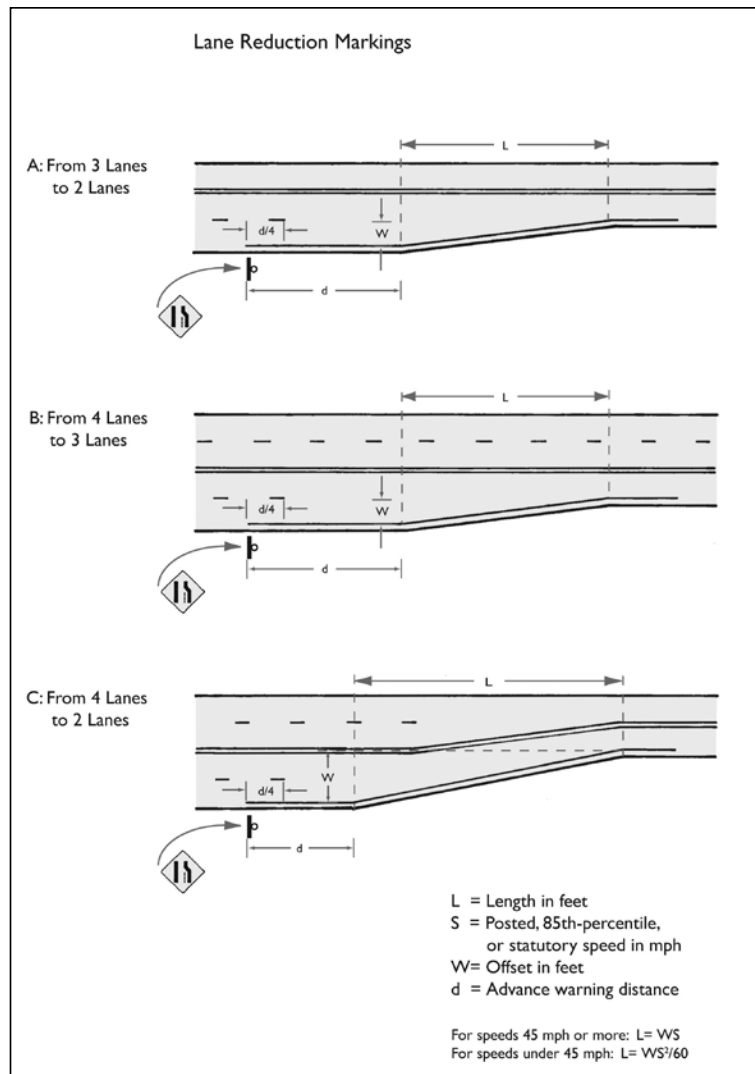

Figure 9.13 Typical transition design and markings. Source: Community, Design + Architecture, adapted from the *Manual on Uniform Traffic Control Devices* (FHWA).

Four-Lane to Three-Lane Conversions (Road Diets)

A road diet is the conversion of a wide street to a narrower one, such as the conversion of a four-lane undivided thoroughfare into a three-lane street composed of two travel lanes and a two-way left-turn lane. This conversion provides additional space to accommodate other desirable features such as bike lanes, wider street-sides, pedestrian refuge, landscaping, or on-street parking. Case studies demonstrate that road diets reduce conflicts at intersections, reduce accidents and have minimal effects on traffic capacity and diversion on thoroughfares under 20,000 vehicles per day.

Three-lane roadways can improve emergency response by allowing emergency vehicles to bypass congestion by using the two-way left-turn lane. They create opportunities for pedestrian refuges at midblock and intersection crossings and eliminate the common “multiple threat” hazards pedestrians experience crossing four-lane roads. Other benefits include easier egress from driveways (improved sight distance), smaller curb return radius by increasing the effective radius of the road, improvements for transit (allows curbside stops outside of travel lane) and buffers street tree branches from closely passing trucks. Road diets can improve the flow of traffic and reduce travel speeds, particularly when used in conjunction with roundabouts (see Chapter 10 section on modern roundabouts). **Figure 9.14** shows a street before and after a road diet.

Converting four-lane roads to three lanes and adding a raised median and on-street parking may result in the thoroughfare failing to meet local fire districts minimum clear travelway requirements. See discussion on emergency vehicle operations earlier in this chapter.

For more detailed information, design guidance and case studies, refer to *Road Diet Handbook: Setting Trends for Livable Streets*, Second Edition (Parsons Brinkerhoff, Rosales, 2007).

Midblock Crossings

Background and Purpose

Midblock crossings provide convenient locations for pedestrians to cross urban thoroughfares in areas with infrequent intersection crossings or where the nearest intersection crossing creates substantial out-of-direction travel. When the spacing of intersection crossings is far apart or when the pedestrian destination is directly across the street, pedestrians will cross where necessary to get to their destination directly and conveniently, exposing themselves to traffic where drivers might not expect them. Midblock crossings, therefore, respond to pedestrian behavior. Properly designed and visible midblock crosswalks, signals and warning signs warn drivers of potential pedestrians, protect crossing pedestrians and encourage walking in high-activity areas.

Related Thoroughfare Design Elements

- On-street parking
- Pedestrian refuge islands
- Medians
- Curb extensions
- Bicycle lanes

General Principles and Considerations

Installing midblock crosswalks can help channel pedestrians to the safest midblock location, provide visual cues to allow approaching motorists to anticipate pedestrian activity and unexpected stopped vehicles and provide pedestrians with reasonable opportunities to cross during heavy traffic periods when there are few natural gaps in the approaching traffic streams (**Figure 9.15**). General principles and considerations regarding midblock crossings include the following:

- Appropriate stopping sight distance is a critical part of the design of midblock crossings. Refer to AASHTO’s *Policy on Geometric Design of Streets and Highways* (2004) for guidance in determining sight distance.
- The practitioner should always evaluate a number of factors before installing midblock crosswalks, including proximity to other crossing points, sight distance, vehicle speed, crash records, illumination, traffic volumes, pedestrian volumes and nearby pedestrian generators.
- In the urban environment, pedestrians should not be expected to make excessive or inconvenient diversions in their travel path to cross at an intersection. On the other hand, because midblock crossings are not generally expected by motorists, they should be used only where truly needed and appropriately signed, marked and illuminated.
- Midblock crossings should be identifiable to pedestrians with vision impairments. Where there is a signal, a locator tone at the pedestrian detector might be sufficient. A tactile strip across the width of the sidewalk at the curblineline and



Figure 9.14 Before and after illustration of a road diet. Source: Claire Vlach, Bottomley Design & Planning.

at pedestrian refuge islands needs to be used so that visually impaired pedestrians are alerted to the presence of the crossing.

- For a crosswalk to exist at a midblock location, it must be a marked crosswalk and have high visibility to drivers who may not anticipate a midblock crossing. Midblock crosswalks should be marked with a higher-visibility crosswalk marking such as longitudinal or diagonal lines or should be constructed with a high-contrast alternative pavement.
- When an unsignalized midblock crosswalk is installed, warning signs should be placed for both directions of traffic. A pedestrian warning sign with an “AHEAD” notice or a distance plaque should be placed in advance of the crossing, and a pedestrian warning sign with a downward diagonal arrow plaque should be placed at the crossing location. On multilane facilities, an advanced stop bar should be considered.

Recommended Practice

The recommended practice for midblock crossings on urban thoroughfares is shown in **Table 9.4**. Examples are provided in **Figures 9.16 through 9.19**.

Justification

Street life and activity entering and leaving buildings are often oriented toward midblock locations rather than intersections. Pedestrian convenience is related to walking distance as well as safety in crossing the roadway. Well-designed midblock crosswalks are highly visible to motorists, bicyclists and pedestrians; reduce walking distance; and contribute to pedestrian convenience.



Figure 9.15 Midblock crosswalks provide opportunities to cross streets with long distances between intersection crossings. Source: Claire Vlach, Bottomley Design & Planning.

Table 9.4 Recommended Practice for Midblock Crossings

General
The decision to locate a midblock crosswalk will be based on numerous factors. Generally, however, consider providing a marked midblock crossing when protected intersection crossings are spaced greater than 400 feet or so that crosswalks are located no greater than 200 to 300 feet apart in high pedestrian volume locations, and meet the criteria below.
Midblock crossings may be considered when there is significant pedestrian demand to cross a street between intersections, such as connecting to major generators or transit stops.
Midblock crosswalks should be located at least 100 feet from the nearest side street or driveway so that drivers turning onto the major street have a chance to notice pedestrians and properly yield to pedestrians who are crossing the street.
Criteria
Streets with an average daily traffic volume (ADT) of 12,000 vehicles per day or less.
Multilane streets carrying less than 15,000 ADT if a raised pedestrian refuge median is provided.
Operating speeds less than 40 mph.
A minimum pedestrian crossing volume of 25 pedestrians per hour for at least four hours of a typical day.
Adequate sight distance is available for pedestrians and motorists.
Recommendations
Conform to PROWAG guidelines for the disabled and visually impaired.
Unsignalized midblock crosswalks should not be provided on streets where traffic volumes do not have gaps in the traffic stream long enough for a pedestrian to walk to the other side or to a median refuge. At locations with inadequate gaps that also meet MUTCD signalization warrants, consider a signalized midblock crossing.
Consider a signalized midblock crosswalk (including locator tone and audio pedestrian signal output as well as visual pedestrian countdown signal heads) where pedestrians must wait more than an average of 60 seconds for an appropriate gap in the traffic stream. When average wait times exceed 60 seconds, pedestrians tend to become impatient and cross during inadequate gaps in traffic. If this initial threshold is met, check pedestrian signal warrants in the MUTCD.
Provide overhead safety lighting on the approach sides of both ends of midblock crosswalks.
Provide wheelchair ramps or at-grade channels at midblock crosswalks with curbs and medians.
Provide raised median pedestrian refuge at midblock crossings where the total crossing width is greater than 60 feet, and on any unsignalized multi-lane thoroughfare crossing.
Use high-visibility (ladder-style) crosswalk markings to increase visibility longitudinally.
Provide advance stop or yield lines to reduce multiple-threat crashes.
Provide advance crosswalk warning signs for vehicle traffic.
Provide curb extensions at midblock crosswalks with illumination and signing to increase pedestrian and driver visibility.
"Z" crossing configurations should be used for midblock crossings with medians wherever possible (see Figure 9.16). Provide an at-grade channel in median at a 45-degree angle toward advancing traffic to encourage pedestrians to look for oncoming traffic.
Other Considerations
A strategy to calm traffic speeds in advance of and at a midblock crossing is to raise the pavement to meet the sidewalk elevation by use of gentle ramps (see Figure 9.17). Consider use of overhead flashing beacons.

Sources:

Safety Effects of Marked vs. Unmarked Crosswalks at Uncontrolled Locations, FHWA, 2002

Manual on Uniform Traffic Control Devices, FHWA, 2009 Edition

Guide for the Planning, Design and Operation of Pedestrian Facilities, AASHTO, 2004

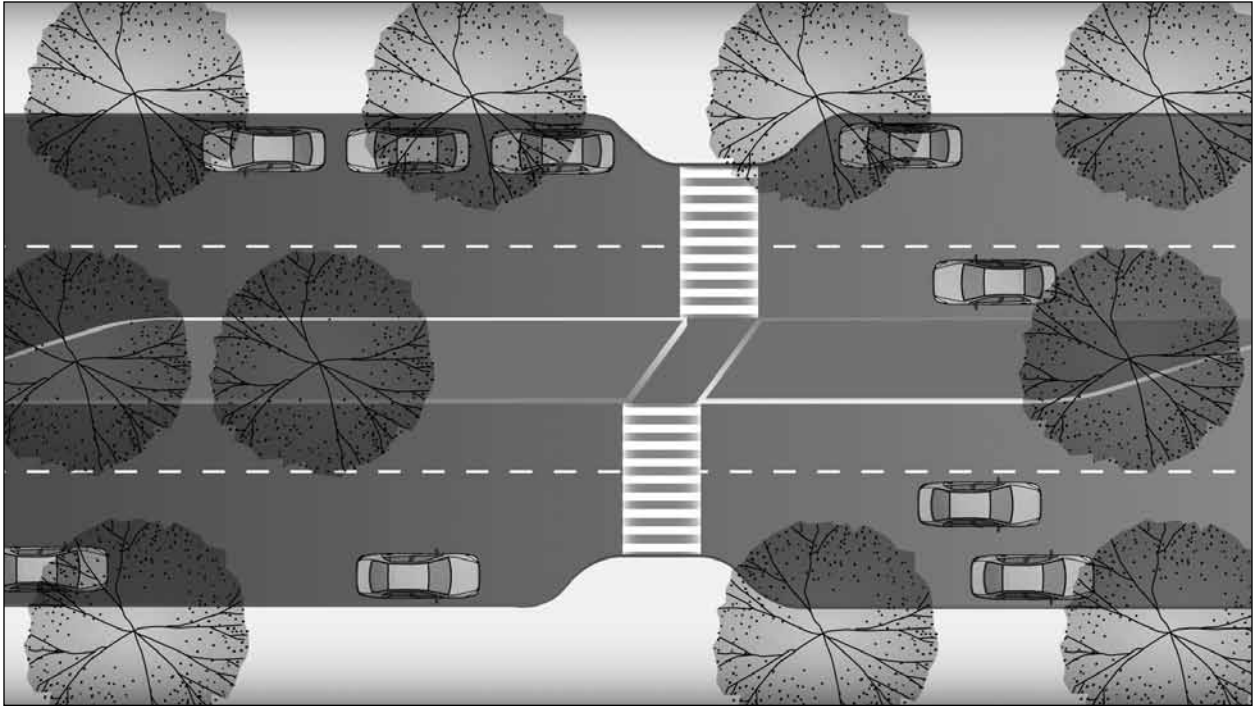

Figure 9.16 Midblock crossings with a “Z” configuration force pedestrians crossing the median to look toward oncoming traffic. Avoid street trees that interfere with visibility. Source: Kimley-Horn and Associates, Inc.

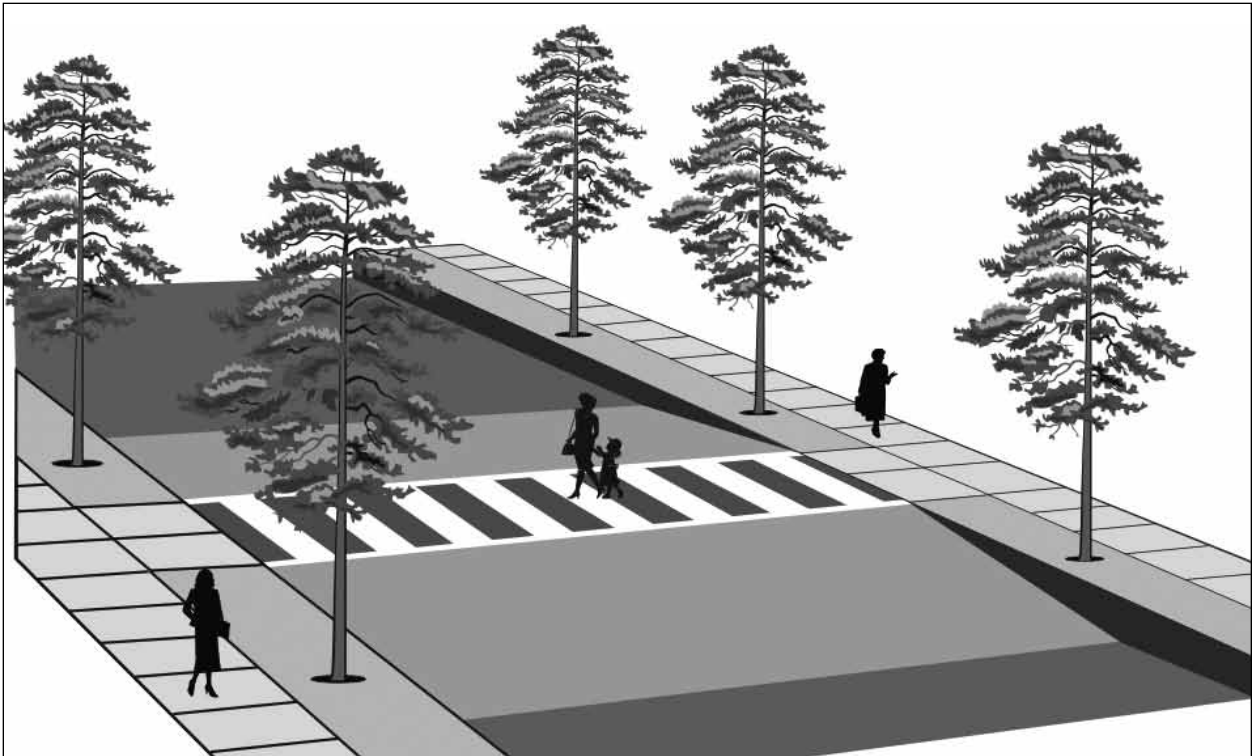

Figure 9.17 The raised roadway crosswalk concept combines midblock crosswalks with traffic calming devices. Source: Kimley-Horn and Associates, Inc.



Figure 9.18 Midblock crossing with pedestrian detection and in-pavement lights. Source: Kimley-Horn and Associates, Inc.



Figure 9.19 Example of a signalized midblock crossing. Source: Kimley-Horn and Associates, Inc.

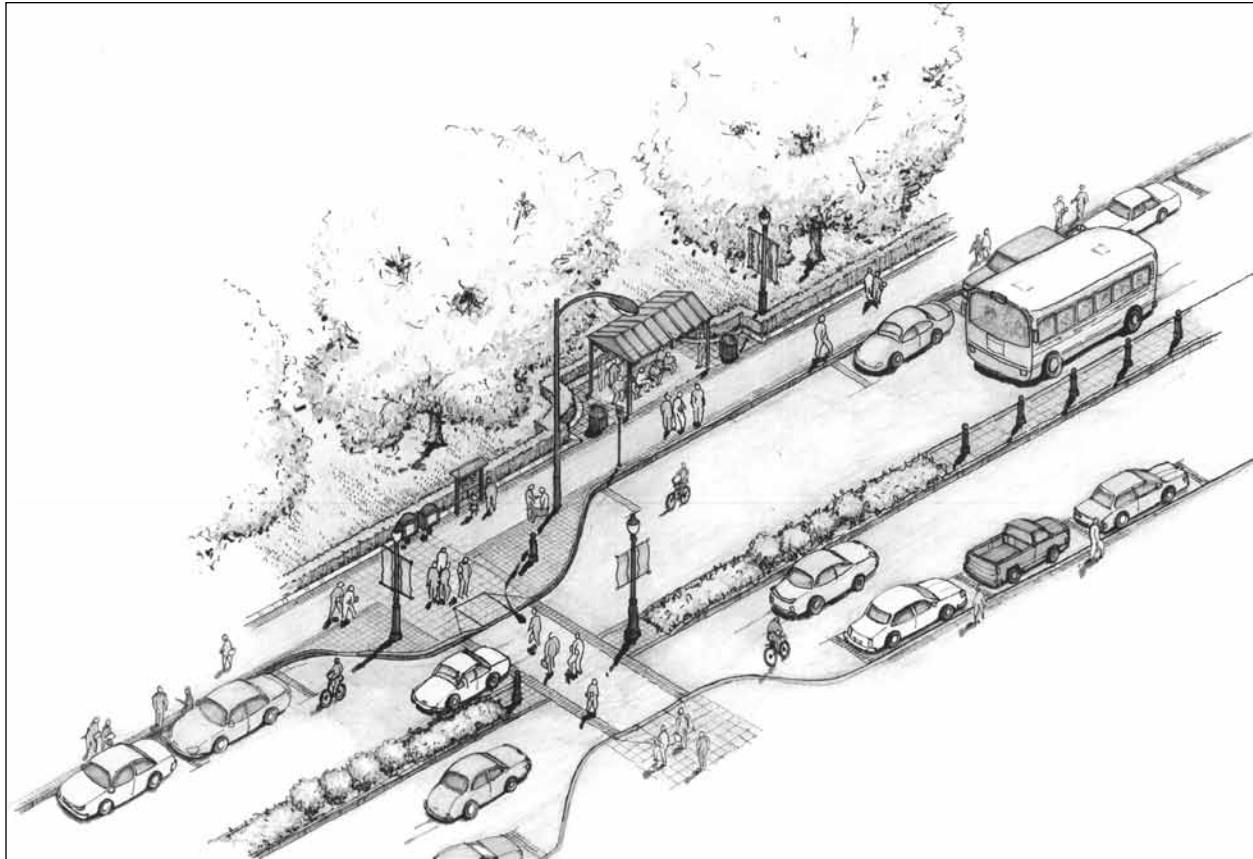

Figure 9.20 Refuge islands can be used at midblock locations, channelized right turns, or at long intersection crossings. Source: Kimley-Horn and Associates, Inc.

Pedestrian Refuge Islands

Background and Purpose

Refuge islands provide pedestrians and bicyclists a refuge area within intersection and midblock crossings. While in walkable urban areas it is desirable

that thoroughfares have short crossings, on wide thoroughfares, or where less mobile pedestrians need to cross, refuge islands provide a location for pedestrians or bicyclists to wait partially through their crossing. Refuge islands also break up crossings at complex multilane and multilegged intersections into shorter and easier portions for pedestrians to cross.

Related Thoroughfare Design Elements

- Lane width
- Right-turn channelization
- Modern roundabouts
- Medians
- Midblock crossings
- Curb extensions

General Considerations

Refuge islands are provided in the median and on right-turn channelized islands (**Figure 9.20**). Refuge islands should be considered for intersections and midblock crossings for which one or more of the following conditions apply:

- Unsignalized midblock and intersection crossings of a high-volume thoroughfare of four or more lanes to allow crossing pedestrians and bicyclists to concentrate on crossing one direction of travel at a time; or

- Signalized crossings frequently used by a number of people who walk slower than 3.5 feet per second, such as older persons, schoolchildren, persons with disabilities and so forth.

At signalized intersections, the provision of pedestrian refuges increases the crossing distance of most pedestrians (walking at a rate of 3.5 to 4 feet per second) who do not need to use the refuge and increases the traffic signal's overall cycle length and resulting delay (delay that is also experienced by pedestrians). Thus, the practitioner needs to balance the needs of all users when considering a refuge in the second condition above.

Recommended Practice

Recommended practices regarding pedestrian refuge islands include the following:

- Islands should be sufficiently large to command attention. For pedestrian refuge, islands should have an area at least 120 square feet with minimum dimensions of 6 feet wide and 20 feet long.
- Refuge islands are generally good practice in urban areas to reduce pedestrian exposure to traffic. Specifically, refuge islands may be considered on urban thoroughfares where the unsignalized pedestrian crossing crosses four or more lanes or greater than 60 feet, or under special circumstances such as school crossings and where elderly pedestrians cross.
- Medians expected to be used as pedestrian refuges should have vertical curbs to delineate the pedestrian refuge from the surrounding roadway.
- If part of a designated multi-use trail system, refuge islands are recommended to be 10 feet wide (8 feet minimum).
- Crossing through pedestrian refuges must be accessible with channels at street grade, detectable warnings and audio and visual output at signalized crossings.

Justification

Short crosswalks help pedestrians cross streets more safely with less exposure to vehicle traffic. They also require shorter pedestrian signal phases to cross, thereby reducing traffic delays. Pedestrian comfort and safety when crossing wide intersections is an essential component of good pedestrian facility design. On wide streets, the median can provide a refuge for those who begin crossing too late or are slow walkers. At unsignalized intersection and midblock crossings, medians permit crossings to be accomplished in two stages, so that pedestrians only have to concentrate on crossing one direction of the roadway at a time.

Transit Design

Background and Purpose

Many urban thoroughfares accommodate public transportation. The types of services accommodated on thoroughfares ranges from local bus service to bus rapid transit (BRT) to trolleys and light rail transit (LRT). These types of transit service can be accommodated either within a dedicated right of way in the thoroughfare or in mixed-flow lanes. In both cases the design of the thoroughfare needs to consider the special requirements of transit vehicles, running ways and operations, whether they exist or are planned for the future. The purpose of this section is to identify

Related Thoroughfare Design Elements

- Cross-section determination
- Lane width
- Medians
- Bike lanes
- Curb return radii
- Curb extensions
- Bus stops in the traveled way
- Bus stops at intersections

Table 9.5 Types of Public Transportation Using Urban Thoroughfares

Transit Type	Definition
Local Bus	Bus service operating at a fixed frequency that serves designated stops along a fixed route. Fares are collected onboard by the bus operator. Local bus service usually operates in mixed-flow lanes on urban thoroughfares. The typical average operating speed is low and is dependent on the operating speed of the urban thoroughfare.
Rapid Bus	Bus service similar to local bus serves designated stops along fixed route but with fewer stops than local service. This service is also known as commuter express. Fares are collected onboard by the bus operator. Rapid bus service usually operates along mixed-flow lanes on urban thoroughfares. Rapid buses may operate only during peak travel periods along peak directions. Some rapid bus systems use transit priority signal systems to improve headways, and queue jump lanes to bypass congestion at intersections.
Bus Rapid Transit (BRT)	Enhanced bus service that operates within its own right of way or designated lanes along the urban thoroughfares. BRT may utilize off-board fare collection to minimize boarding delays. BRT stops are typically spaced one mile apart and operate with high-frequency headways. The average speed of BRT is higher than that of rapid bus. BRT buses and stations are branded to distinguish them from local bus services. Stations frequently have more passenger amenities than typical bus stops. BRT systems use transit priority signal systems to improve headways, and queue jump lanes to bypass congestion at intersections.
Streetcar/Light Rail Transit (LRT)	Streetcars and LRT are fixed guideway transit systems. Streetcars (or trolleys) are electrically powered vehicles that may share the street with other modes of transportation and operate in mixed-flow lanes. LRT is typically electrical powered rail cars within exclusive rights of way in thoroughfare medians but may also operate in mixed-flow lanes. LRT is provided with traffic signal prioritization at intersections and requires special signal phasing to reduce conflicts. LRT utilizes off-board fare collection at transit stations. Transit stations, whether on the median or edges of thoroughfares, may require substantial right of way.

the key elements of transit that affect the design of thoroughfares. Detailed design guidance on dedicated transitways, particularly for rail systems, is beyond the scope of this report, but the information presented here can inform the thoroughfare planning and design process.



Figure 9.21 An example of a dedicated transitway in the outside lane of an urban thoroughfare. Note the bike lane located between the curb and the transitway. Source: Kimley-Horn and Associates, Inc.

Types of Transit on Thoroughfares

The different types of public transportation systems that use urban thoroughfares have varying physical and operating characteristics that will establish the design controls and geometric design parameters in thoroughfare design. It is important for the practitioner to understand the dimensions and capabilities of the type of transit using, or expecting to use, the thoroughfare and the ramifications the transit vehicles, their operation and their stops and stations will have on the design of the thoroughfare.

Table 9.5 describes the common types of public transportation systems using urban thoroughfares.

Transit Facilities on Thoroughfares

Transit on urban thoroughfares can utilize one or more of the following running way configurations:

- Mixed-flow travel lanes;
- Transit or high-occupancy vehicle (HOV) lanes in median or adjacent to mixed-flow lanes used for transit either full time or during peak periods;

- Reversible or contraflow dedicated transit lanes (in median or in outside travel lanes);
- Dedicated and separated transitway in inside or outside travel lanes (Figures 9.21 and 9.22); and
- Dedicated and separated transitway within thoroughfare median (Figure 9.23);
- Transit-only streets, busways, or transit malls.

Each running way configuration requires that the practitioner understand the right of way and dimensions required (not only for the running ways but for stops and stations), the transition required when changing from one configuration to another and how the transit vehicle will use intersections. Further, rail systems can be single tracked, double tracked, or both, which affects thoroughfare width planning.

Like running ways, bus and rail stops and stations can have multiple configurations depending on the type of transit, the available right of way, the type of service and other factors. As used in this report, a “stop” is a location where a transit vehicles stops to allow passengers to board or alight. A stop, at a minimum, is identified by a sign but may have some passenger amenities such as benches and shelters. A “station” is a more elaborate transit stop with substantial passenger amenities and may have facilities such as ticket



Figure 9.22 A simulation of a bus rapid transit center median station with dual outside platforms located at the far side of an intersection. Source: AC Transit.

offices, restrooms, or other services. Stations may accommodate multiple vehicles or have integrated intermodal facilities. Stops and stations can utilize one or more of the following configurations:

Local, Rapid and Bus Rapid Transit

- Midblock bus stop (curbside, pullout or bay, or bus bulb; see section on Bus Stops in the Traveled Way in this chapter);
- Near-side or far-side intersection bus stop (curbside, pullout or bay, or bus bulb; see Bus Stops at Intersections in Chapter 10); and
- Center median station with single center or dual outside platforms (midblock or near and far side of intersection), potentially with crossover for buses with right-side doors.

Light Rail, Streetcar, or Trolley Transit

- Median station with dual side platforms;
- Median station with single center platform;
- Median station with single side platform (midblock or near and far side of intersection); and
- Curbside station at outside edge of thoroughfare traveled way.

The thoroughfare designer needs to coordinate with the responsible transit agencies to identify the appro-



Figure 9.23 This thoroughfare in Houston, Texas has light rail transit running in dedicated inside travel lanes. Source: Texas Transportation Institute.

Table 9.6 Integrating Transit into Thoroughfare Planning and Project Development

Thoroughfare Planning or Project Development Stage	Transit Considerations
Systems and Network Planning Identify thoroughfare network deficiencies and conceptual solutions	Identify transit system deficiencies and long range transit needs
Corridor Planning Develop and assess alternatives for corridor	Develop and assess thoroughfare and transit alternatives within the corridor
Project Scoping Develop project definitions that address deficiencies	Identify transit elements to be included in the definition of thoroughfare projects
Programming Prioritize projects and define program based on funding availability	Develop transit project phasing and identify transit elements to be included in project funding
Environmental and Design Design project, assess impacts and estimate cost	Identify transit requirements to be integrated into thoroughfare design

Adapted from *Transit Vehicles and Facilities on Streets and Highways (Phase II) Final Report*. Transit Cooperative Research Program Project D-09, 2007. Privileged Document.

appropriate running way configuration, transitions and location and design of stops and stations.

Planning for Transit

Transit systems are planned at the regional, citywide and/or corridor level (see Chapter 2). Most large-scale rail transit system decisions (technology, type, service and routing) are made in statewide or regional long-range transportation plans. Typically, an alternatives analysis that evaluates the feasibility of implementing the transit system on the proposed routes is prepared for major public transportation systems such as LRT or BRT that seek federal funding. These studies may even include preliminary engineering. Transit systems planning and corridor planning follow the same general process outlined in Chapter 2 for the thoroughfare planning process.

Transit considerations can be integrated into thoroughfare planning and design at several stages within the regional planning, corridor planning and project development processes as outlined in **Table 9.6**.

When designing thoroughfares that are identified as future transit corridors, the practitioner will need to consider a number of factors in order to reserve the appropriate right of way and to ensure the design is relatively easily converted to accommodate transit. Some of these factors are identified in **Table 9.7**. In addition

to specific design issues, the practitioner may need to consider other planning considerations such as:

- Potential for converting bus transit to LRT needs to consider LRT design parameters for vertical clearance, track integration, right of way, grades, pavement structural design, drainage and utilities for LRT power and communication.
- Stop and station locations and spacing to meet changing context and future development.
- Potential change in transit routing.
- Alternatives analysis and trade-offs assessment of transit priority treatments.
- Coordinating with transit agencies to install fiber-optic cabling to serve intelligent transportation systems (ITS) on transit corridors, such as automated passenger information systems at stops and stations.

Transit Design Parameters

Although it is not the intent of this report to present guidelines for the extensive field of transit facility design, **Table 9.8** presents a select number of minimum dimensions and design parameters for some of the more common transit facility components that might be useful to the thoroughfare design practitioner in determining cross-sectional elements.

Table 9.7 Transit Related Factors to Consider in Thoroughfare Design

Thoroughfare Design Component	Factors to be Considered
Streetside (Chapter 8)	Streetside width at stops or stations
	Space for passenger requirements such as shelters, seating, waiting areas, trees, lighting and so forth.
	Accessibility requirements (lift pads)
Traveled Way (Chapter 9)	Available total right of way to accommodate running ways, stops and stations
	Lane width to accommodate transit vehicle in mixed-flow lanes
	Type of running way and separation (dedicated transitway, reversible/contraflow, HOV, median lanes, concurrent lanes)
	Median width to accommodate running ways and stations
	Pedestrian access to median stations
	Ability to accommodate on-street parking on transit streets
	Parking restrictions near stops and stations
	Bike/bus conflicts where buses stop in bike lane
	Pavement depth to accommodate buses; concrete pads at bus stops
	Additional width for transit facilities versus pedestrian crossing distance
	Roadway structural design for LRT
	Horizontal and vertical clearances for transit; maintenance requirements such as tree pruning
	Necessity for bus bays
	Transit operations on one-way streets, location of stops, turns
	Provision of an enforcement area on exclusive bus facilities (e.g., extended bus turnouts)
Intersections (Chapter 10)	Transit vehicle turning radius and curb return/extension design
	Queue jump lanes and special signal phasing
	Accommodating transit vehicles in roundabouts
	Near-side or far-side bus stops, BRT or rail stations and traffic operations
	Transit priority signal systems or special phasing for rapid and BRT
	Bus priority treatments; intersection design when contraflow bus lanes are used
	Special signal phasing and equipment for LRT
	Vehicle left-turn lanes adjacent to median stations
	Vehicle turn prohibitions in constrained rights of way or for operational efficiency
	Curb extension bus stop versus curbside stop
	Pavement grades through intersections and bus passenger comfort
	Movement restrictions and bus exemptions

Table 9.8 Minimum Dimensions for Transit Facilities in Thoroughfares

Transit Facility or Design Element	Minimum Dimension
Lane width to accommodate standard urban bus, LRT vehicle, or streetcar	11 feet
Curbside bus stop length and no-parking zone (add 20 feet for articulated vehicles)	
Near-side bus stop	100 feet
Far-side bus stop	80 feet (Plus 5 feet from crosswalk or curb return)
Far-side bus stop after turn	90 feet (Plus 5 feet from crosswalk or curb return)
Midblock	120 feet
Bus bulb stop length (near side or far side)	40 feet
Distance between front of vehicle at near-side stop and crosswalk	10 feet
Single-side LRT/BRT platform width conforming to ADA guidelines	10 feet (8 feet plus 2 feet tactile strip)
Distance between LRT double track centerlines	12 feet
Maximum grade for LRT operation	6%
Height of platform	Low: 10 inches High: 36 inches
Width of two-track LRT channel	22 feet
Vertical clearance for LRT (top of rail to bottom of wire)	11.5 feet
Width of right of reserve for two tracks	19–33 feet
LRT/BRT station widths (including running way)	
Dual outside platforms	41 feet
Single center platform	55 feet
Single outside platform	31 feet

Bus Stops in the Traveled Way

Background and Purpose

There are more than 9.4 billion trips made by transit in the United States each year, with nearly 5.3 billion trips made by bus (National Transit Database 2006). Buses are the most common form of mass transit in the country, and the majority of bus travel occurs on urban thoroughfares in metropolitan areas. Since urban thoroughfares serve as the primary access and mobility routes for mass transit, they are the best locations for investment in transit facilities and public amenities that provide direct access to bus stops and functional, attractive and comfortable places to wait for transit. The placement and design of bus stops affect the efficiency of the transit system, traffic operations, safety and people's choices to use transit. Since there is no equivalent to the AASHTO Green Book for transit design guidance, transit agencies develop guidelines and practices for bus stop planning, placement and design. Design guidelines include compliance with ADA requirements to ensure that transit is accessible. This section addresses general guidance for the planning and design of bus stops on urban thoroughfares compiled from the design guidelines of transit agencies. Location-specific guidance should be obtained from local transit agencies.

Related Thoroughfare Design Elements

- Lane width
- Midblock crossings
- Curb extensions
- Transit design
- On-street parking and configuration

General Principles and Considerations

Fundamentals of Bus Stop Placement

The location of a bus stop must address both traffic operations and passenger accessibility issues. If possible, the bus stop should be located in an area where typical amenities, such as a bench or shelter, can be placed in the public right of way. A bus stop location

should consider potential ridership, traffic and rider safety and bus operations elements that require site-specific evaluation. Significant emphasis should be placed on factors affecting personal security. Well-lit open spaces visible from the street create a safer environment for waiting passengers.

Elements to consider when determining bus stop placement include:

- Proximity to major trip generators;
- Presence of sidewalks, crosswalks and curb ramps;
- Nearby enhanced crossings, either midblock or at an intersection;
- Access for people with disabilities;
- Passenger transfers to other routes; and
- Effect on adjacent property owners.

Traffic and rider safety elements to consider in bus stop placement include:

- Conflict between buses, other traffic and pedestrians;
- Crossing to an opposite bus stop—every bus stop should be considered a pedestrian crossing point;
- Passenger protection from passing traffic;
- Width of sidewalks;
- Width of furnishings zone as well as locations of any obstructions;
- Pedestrian activity adjacent to stop;
- All weather surface to step to/from the bus;
- Open and visible spaces for personal security and passenger visibility; and
- Street illumination.

Bus operations elements to consider in bus stop placement include:

- Accessibility and availability of convenient curb space;
- Adequate curb space for the number of buses expected at the stop at any one time;
- On-street automobile parking and truck delivery zones;

Table 9.9 Advantages and Disadvantages of Midblock Bus Stops

Advantages	Disadvantages
Minimizes sight distance problems for motorists and pedestrians	Requires additional distance for no-parking restrictions
Might result in passenger waiting areas experiencing less pedestrian congestion	Increases walking distance for patrons crossing at an intersection or requires special features to assist pedestrians with midblock crossing
Might be closer to passenger origins or destinations on long blocks	Encourages uncontrolled midblock pedestrian crossings
Might result in less interference with traffic flow	Only serves adjacent generators and does not afford system transfers to other lines often found at intersections

- Traffic control devices near the bus stop, such as signals or STOP signs;
- Volumes and turning movements of other traffic, including bicycles;
- Proximity and traffic volumes of nearby driveways;
- Street grade;
- Ease of reentering traffic stream; and
- Proximity to rail crossings.

The preferred location for bus stops is the near side or far side of an intersection (see the section on intersection bus stops in Chapter 10). Intersection stops provide the best pedestrian accessibility from both sides of the street and the cross streets and provides connection to intersecting bus routes.

Bus stops may also be placed at a midblock location on long blocks or to serve a major transit generator. At midblock bus stops ensure crosswalks are placed behind the bus stop, so passengers do not cross in front of the bus, where they are hidden from passing traffic. **Table 9.9** presents the advantages and disadvantages of midblock bus stops.

Stops should be placed to minimize the difficulties associated with lane changes and weaving maneuvers of approaching vehicles. Where it is not acceptable to stop the bus in traffic and a bus pullout is justified, a far-side

Standard transit bus dimensions

Overall height: 10 feet, 6 inches

Overall width: 10 feet, 4 inches (including mirrors)

Overall length (large bus): 40 feet

Overall length (articulated bus): 60 feet

Wheelchair lift dimensions

Width: 4 feet

Extension (from edge of bus): 4 feet, 6 inches

Turning radii

40-foot coach:

Inner rear wheel – 25.5 feet

Outer front corner – 47.8 feet

Centerline radius – 40.8 feet

60-foot articulated:

Inner rear wheel – 21.3 feet

Outer front corner – 44.3 feet

Centerline radius – 35.5 feet

Source: Orange County Transportation Authority (OCTA) *Bus Stop Safety and Design Guidelines*, Orange County, California

or midblock curbside stop is generally preferred (see section on intersection bus stops in Chapter 10).

Spacing of Bus Stops

Optimal bus stop spacing varies depending upon the type of transit service provided, urban context zone, location of major attractors, physical barriers and local community goals. Appropriate spacing ranges from 400 to 500 feet for downtown circulator shuttles and low-volume community service routes to greater than 2,000 feet (up to one mile) for bus rapid transit and express lines. Designers should consult with the local transit provider for design guidance on bus stop spacing and placement.

Recommended Practice

Design Vehicle

On urban thoroughfares with transit routes, the bus is one of the design vehicles used in thoroughfare design. Some transit agencies use smaller, urban-scaled transit vehicles (32-foot coach) and use of vehicles with the smallest possible turning radii should be encouraged. Most fleets use standard coaches with the design specifications described here. Important dimensions of standard and articulated buses are shown in the sidebar, including the turning radii requirements for a 40-foot coach and 60-foot articulated bus. The minimum inside radius is 21 to 26 feet and the minimum outer radius is 44 to 48 feet. Turning templates should be used in the design of facilities to identify curb return radius and required pavement width to avoid vehicle encroachment into opposing travel lanes. Additional allowance should be made for:

- Bicycle racks on front of bus (which adds 3 feet to the length of the bus); and
- Restrictions to bus overhang.

Parking Restrictions at Bus Stops

It is important that parking restrictions (either curb markings or NO PARKING signs) be placed at bus zones (Figure 9.24). The lack of parking restrictions impacts bus operations, traffic movement, safe sight distance and passenger access. Considerations include:



Figure 9.24 Parking restrictions at a bus stop.
Source: Texas Transportation Institute.

- Bus may have to double park when at a stop, interfering with traffic movements;
- Passengers would have to maneuver between parked vehicles when entering or exiting the bus, which can endanger the passengers; and
- Bus could not use the curb/sidewalk to deploy its lift to board or alight wheelchair passengers.

In addition to a minimum 40- to 60-foot long bus stop, no-parking zones before and after the bus stop allow buses to pull into the bus stop and reenter traffic. Use the following dimensions for no-parking zones at midblock bus stops that typically accommodate a single bus:

- Before stop: 40-foot minimum.
- After stop: 40-foot minimum.

Parking restrictions are not necessary when curb extension bus stops are provided.

Curb Extension Bus Stops at Midblock Locations

Bus bulbs (or curb extension bus stops) are bus stops in which the curb is extended into the on-street parking lane, and the bus stops within the travel lane. Refer to Chapter 10 (Curb Extension Bus Stops) for more information on this type of stop.



Figure 9.25 A typical bus turnout on an arterial Avenue. Source: Kimley-Horn and Associates, Inc.

Bus Turnouts

Bus turnouts (a recessed curb area located adjacent to the traffic lane as shown in **Figure 9.25**) are desirable only under selected conditions because of the delay created when the bus must reenter traffic. Bus turnouts are typically used only on thoroughfares with higher target speeds than those included in this report.

Bus turnouts have the following advantages:

- Allow traffic to proceed around the bus, reducing delay for other traffic;
- Maximize vehicular capacity of high-volume vehicle mobility priority thoroughfares;
- Clearly define the bus stop;
- Passenger loading and unloading can be conducted in a more relaxed manner; and
- Eliminate potential rear-end accidents.

Bus turnouts have the following disadvantages:

- Make it more difficult for buses to reenter traffic, increasing bus delay and average travel time for buses;
- Difficulty of buses pulling parallel to curb, reducing accessibility;
- Greater crash risk for buses pulling back into traffic than buses stopped in traffic lane; and
- Use additional space and might require right-of-way acquisition.

Bus Turnout Design

Typical urban bus turnouts are usually comprised of an entrance taper (40 to 60 feet), stopping area (40 to 60 feet per each standard and articulated bus respectively) and exit taper (40 to 60 feet).

Passenger Boarding Area

The bus stop passenger boarding area is the area described as a firm, solid platform for deployment of wheelchair lifts and for other bus stop features, such as shelters, and benches. The boarding area must include a front and rear loading area free of obstacles. The boarding area may also be a pathway, but greater clearance than a typical sidewalk is required to allow deployment of the wheelchair lift. **Figure 9.26** shows a basic boarding area.

The following criteria for boarding areas should be used to ensure compliance with PROWAG requirements:

- Door clearance: minimum of 5 feet wide along the curb by 8 feet deep (from face of curb to back of boarding area);
- Distance between front and rear boarding area is 18 feet;
- Surface material is stable, firm and slip resistant;
- Slope does not exceed 1 foot vertical over 20 feet horizontal (5 percent);
- Cross slope does not exceed 1 foot vertical over 50 feet horizontal (2 percent);



Figure 9.26 A simple passenger boarding area. Source: Kimley-Horn and Associates, Inc.

- Clear throughway width of 48 inches maintained in boarding area; and
- Vertical clearance of 84 inches maintained in boarding area.

Every bus stop should include the following minimum elements for passenger accessibility, safety and comfort:

- In streetsides with a detached sidewalk (planting strip between curb and sidewalk), practitioners should:
 - Provide a landing area adjacent to the curb for a minimum distance of 34 feet in length and a minimum of 8 feet in depth (from face of curb); and
 - Provide a connecting pathway from pedestrian throughway to landing area.
- Provide convenient pedestrian pathways/access ways to and from adjacent buildings.
- Locate the bus stop so coach operators have a clear view of passengers and waiting passengers can see oncoming buses.
- Minimize driveways in and adjacent to the bus stop area.
- Locate street furniture more than 2.5-foot tall in such a way as to provide motorists exiting nearby driveways clear visibility of the street.
- Passenger boarding area: Pads must have a smooth, broom-finished surface to accommodate high heels and wheelchairs and must have high-strength capacity to bear the weight of a shelter. Pavers (textured/decorative tiles) can be used in combination with a concrete pad for aesthetics. Slope of pad should match slope of adjacent sidewalk and allow drainage of pad (2 percent maximum per PROWAG requirements).
- Landscaping near the passenger boarding area is encouraged to maximize passenger comfort but should be placed far enough back from the curb face to not interfere with the bus or passenger visibility. All landscaping should be located so as not to obstruct the shelter canopy or obscure sight lines at the bus stop. Shade trees are desirable and the preferred location is at the back of the sidewalk.

- Maintain at least 5 feet of clearance between bus stop components and fire hydrants.
- Locate bus stops where there is a standard curb in good condition. Bus stops are designed with the assumption that the bus is the first step. It is more difficult for the elderly and mobility-impaired passengers if the curb is absent or damaged.
- All street furniture should be surrounded by at least 4 feet of horizontal clearance wherever possible for access and maintenance between components. **Figure 9.27** illustrates a typical layout of a shelter and other street furniture.
- There should be at least 10 feet of clearance between the front edge of a pedestrian crosswalk and the front of a bus at a near-side bus stop, and 5 feet between the back edge of a crosswalk and the rear of the bus at a far-side bus stop.
- Whenever possible, avoid placing a bus stop so that the bus wheels will cross over a catch basin as it pulls to the curb, causing the bus to lurch and possibly throw off passenger balance. Additionally, it could eventually cause excessive settlement of the catch basin's structure.
- To avoid splashing waiting passengers as the bus pulls to the curb in wet weather, consider draining away from the curb (**Figure 9.28**).

Passenger Security

Security is one of the primary issues associated with the design of bus stops. Personal security is consistently mentioned in transit studies as a major concern among transit users. The following guidelines should be considered to improve security at bus stops:

- Place bus stops in locations that provide between 2 to 5 lumens of illumination within the bus stop area. If street lighting does not exist, solar lighting could be considered to enhance security at night.
- Ensure adjacent shrubbery is trimmed low and thinned so passengers can view over and behind any hedges. Consider using plants that are open and do not form solid hedges of vegetation.
- Ensure clear visibility of, through and around the bus stop for both passenger surveillance of the environment and law enforcement surveillance. Pro-



Figure 9.27 An example layout of a shelter and other street furniture. Source: Texas Transportation Institute.



Figure 9.28 This bus stop is designed so that stormwater drains away from the curb into a slot drain located in the travel lane. This design keeps buses from splashing waiting passengers when pulling to the curb. Source: Texas Transportation Institute.

vide adequate lines of sight for passengers and law enforcement officers approaching the bus stop.

- Ensure that the pedestrian circulation routes through bus stops and waiting areas are not blocked from view by walls or other structures.
- When placing bus stops, avoid nearby edges and corners of walls that create blind spots.
- Avoid design features that degrade access and security, including sound walls or similar structures that isolate passengers from surrounding neighborhoods. In general, there is no reason to locate bus stops adjacent to sound walls or tall fences, as these locations preclude direct access from adjacent land uses. If unavoidable, provide a pedestrian passage through the wall.
- If possible, provide a public telephone or place the bus stop in view of a public telephone. Consider installation of emergency call boxes at isolated locations.
- Provide secure bicycle parking and ensure that proper clearances are maintained when bicycles are parked.
- If possible, provide multiple exits from bus shelters.
- Remove all evidence of vandalism and regularly repair and maintain benches and shelters to provide passengers with a sense of security.

Justification

Bus stops should be designed to first expedite the safe and efficient loading and unloading of passengers (including those with disabilities) and to allow for efficient transition of the bus between the travel lanes and the bus stop. Because of the multimodal function of urban thoroughfares and to make transit competitive with auto travel, consideration should be given to design features that minimize delay for buses reentering the traffic stream (far-side bus stop placement and curb extension bus stops). The boarding area must be designed, at a minimum, to accommodate ADA/PROWAG requirements, but consideration should be given to boarding areas that can accommodate passenger amenities such as shelters, benches, trees and bicycle parking, even if these amenities will be implemented in the future.

Special Consideration with Stormwater Management

The management of stormwater on walkable urban thoroughfares improves the walking and bicycling environment, aesthetics and the quality of the community as a whole. Green stormwater management practices add value and multiple functionality and should be considered in thoroughfare improvement projects.

Swales in Stormwater Management

Green swale areas can be located in medians, planting strips, islands and other landscaped areas to which stormwater can be directed. Swales are depressed areas that are normally highly porous but are planted with low-maintenance, frequently indigenous types of grass or vegetation that are compatible with the detention, absorption and filtration functions they are designed to serve. The photos below show an example of a median swale, but similar swales can be located in planting strips adjacent to curbs or other locations within the right of way.



If the local soil doesn't percolate or if the median slopes, the design will need a subsurface drain inlet to the storm drain system at the downstream end (as shown in the photo above). Consider that loose soil around the plants would be carried into the storm drain with the first storm requiring fabric or other erosion control on the soil or a sediment trap in the inlet structure.

Source: City of Gresham, OR

Stormwater runoff from thoroughfares and their streetsides must be handled in the right of way. Different communities treat stormwater differently. For some the conventional way is to collect and carry it in storm sewer pipe networks to a treatment plant then an outfall into a water body. For other communities, stormwater is controlled at the source or through treatment control best management practices.

Related Thoroughfare Design Elements

- Streetside
- On-street parking
- Medians
- Street trees and street trees in medians

Background and Purpose

Urban areas have a high percentage of impervious surfaces. This creates the need for stormwater systems that can carry the runoff away from the area or treat, absorb and/or detain the runoff at its source. Failure to sufficiently handle stormwater can result in increased volume and rate of runoff from impervious surfaces increasing the demand for stormwater system capacity. If the system capacity cannot be increased, this can cause flooding and erosion, increase sedimentation and damage the natural habitats that accept the runoff. Further, the concentration of pollutants in the runoff can impact water quality.

A “green street” is a thoroughfare that provides water-quality treatment, retention and/or detention for some or most stormwater within the right of way through use of vegetated facilities, usually swale areas, to reduce, delay and/or filter the amount of water piped directly to outfalls. This report provides a brief discussion of reducing and treating stormwater using source control or treatment control best management practices (BMPs). BMPs are used to accommodate stormwater runoff in one or more ways:

1. **Infiltration**—water enters the ground directly or through pervious surfaces and percolates into the soil.

2. **Retention and detention**—methods to store runoff for later release. Detention measures store water for up to several days after a storm and are usually dry until the next storm. Retention measures are permanent basins that retain water.
3. **Biofiltration**—allow runoff to flow slowly through vegetated slopes and channels, which also capture sediment and pollutants.
4. **Mechanical filtering, screening and de-sedimentation**—devices that can be installed in or adjacent to thoroughfares within the public right of way that use various means to capture solids, such as litter and leaves, or fine particulates, such as dirt and metals.

Where thoroughfare designs can accommodate significant green space, vegetated or grass swales in the streetside or the median can be used to absorb, detain and/or filter runoff. This can reduce the necessary storm sewer capacity and treatment of the runoff.

General Principles

While there are numerous practices for addressing stormwater runoff on sites, the following principles are specific to urban thoroughfare design. These principles represent an objective that either slows or delays the movement of stormwater runoff into the storm drain system, filtrates sediment and pollutants from runoff, or both. Municipalities should encourage developers to implement landscape designs and site BMPs that mitigate increases in site runoff. This reduces the runoff that reaches thoroughfares from adjacent development.

- Minimize the width of the street to the extent feasible to reduce impervious surface.
- Provide pervious surfaces where possible. For example, use streetside planting strips to collect runoff from sidewalks or use pervious hardscape within streetsides of urbanized areas where parkrows are not provided. Consider the maintenance and longevity implications of surfaces that take vehicle loads.
- When retention or detention methods are used, incorporate them into urban water features that

add aesthetic and place-making value to the function.

- Provide mechanical traps to capture pollutants and particulate matter such as dirt and leaves. Consider the maintenance requirements of these features.
- Where the context allows, direct runoff into biofilters or swales rather than underground storm drains.

Where a rigid pavement edge is necessary, consider that swales or other filtration devices can run parallel to the street (in the streetside planting strip or in the median) but also can intersect the street at cross-angles and run between residential lots or within parks or open space.

Guidelines

Complete guidance in relation to storm water management is beyond the scope of this report. Designers are encouraged to seek out other references, such as those outlined at the end of this chapter, or to seek guidance from their local stormwater management agency or water quality control board. However, several guidelines can be followed to develop an initial concept for using a green approach to stormwater management:

- Consider swales for use in medians, planting strips, planters, curb extension, islands, or other green areas of significant size where runoff can be collected and detained until filtered or absorbed or flowed into inlets at the end of swales.
- Employ swales where they can slope downward from the curb or sidewalk.
- Design gutters and curbs so water can enter the swale through breaks or other openings in the curbs; provide for runoff to enter swales directly from adjacent sidewalks or piped from elsewhere in the right of way.
- Considering appearance, cleaning, maintenance and amount of stormwater to be handled in the design of BMPs.
- Blend BMPs in with the rest of the thoroughfare design and context; consider pedestrian con-

nectivity; parking, bicycle and transit needs and provisions; safety; and emergency access.

- Use native, flood-tolerant plants that need little watering, fertilizers, or maintenance.
- Develop and implement a cleaning and maintenance program to preserve stormwater system functionality, appearance and plants.
- Install various commercially available traps, filters and detention or retention devices. Consider the maintenance requirements of these devices.

Recommended Practice

Pervious surfaces and “green” stormwater management should be used in medians, planting strips, planters, islands, sidewalk extensions and other applicable spaces within the right of way where natural stormwater detention, filtration, or absorption is desired, soil conditions are compatible, and where a suitable design is compatible with and supportive of the desired use and appearance of the thoroughfare and surrounding context.

Justification

The growing amount of impervious surfaces in urban areas is increasing runoff and therefore the need for increased stormwater management infrastructure. It also is carrying more waterborne street pollutants needing treatment. The Environmental Protection Agency’s (EPA’s) Clean Water Act has authorized the National Pollutant Discharge Elimination System (NPDES), regulations for improving water quality by addressing point sources that discharge pollutants into waterways, such as stormwater collected in thoroughfares. Use of BMPs within the thoroughfare rights of way can reduce the demand for both storm sewer and treatment facility capacity and also can serve multiple functions.

Special Consideration with Snow Removal

Background and Purpose

During and after a snowstorm, most snow plows operate in emergency or “hurry-up” mode, focusing on opening up lanes for vehicles. Often, when snow is scraped from the vehicular lanes, it is piled up in the bicycle lane, parking lane, or along the sidewalk, thus making it difficult for bicyclists and pedestrians to use the facilities that have been provided for them.

Snow and ice blockages can force pedestrians onto the street at a time when walking in the roadway is particularly treacherous. Many localities that experience regular snowfalls have enacted legislation requiring homeowners and businesses to clear the sidewalks fronting their property within a reasonable time after a snowfall occurs. In addition, many public works agencies adopt snow removal programs that ensure that the most heavily used pedestrian routes are cleared, including bus stops and curb ramps at street crossings, so that snow plows do not create impassable ridges of snow. Adding to the problem, piled snow can create sight distance restrictions.

In some states snow plow operations clear the entire roadway from curb to curb. After the roadway is cleared, a smaller “snow blow” (such as brushes, pickups and plows) are used to clear pedestrian facilities.

In areas that receive regular snow, there will be trade-offs between the recommendations of this report and the efficiency of snow plowing. Some of the recommended design elements such as curb extensions and on-street parking will affect snow plowing operations.

Related Thoroughfare Design Elements

- Streetside
- Bicycle lanes
- On-street parking and configuration
- Medians

These trade-offs need to be clearly communicated in the design process. Further, early collaboration with officials in charge of snow removal is imperative for a successful design.

Recommended Practice

The following practices are recommended regarding snow removal in the design of walkable urban thoroughfares:

- Streetsides should be designed to accommodate a normal level of plowed snow behind the curb without blocking the pedestrian throughway. A wide planting strip or furnishings zone can accommodate plowed snow.
- Avoid designing objects in the furnishings zone that interfere with the ability to plow snow onto the streetside, such as large raised planters, continuous hedges and large utility and traffic control cabinets. Objects that snow can wrap around include trees, signs and light poles.
- The salting of streets for deicing can adversely affect landscaping in the streetside. If salt is used, design the furnishings zone with hard-scape or setback plantings and trees beyond the plow line.

Works Cited

American Association of State Highway and Transportation Officials. 1999. *Guide for the Development of Bicycle Facilities*. Washington, DC: AASHTO.

American Association of State Highway and Transportation Officials. 2004a. *Policy on Geometric Design of Streets and Highways*, Fifth Edition. Washington, DC: AASHTO.

American Association of State Highway and Transportation Officials. 2004b. *A Guide for Achieving Flexibility in Highway Design*. Washington, DC: AASHTO.

Federal Highway Administration. 2009. *Manual on Uniform Traffic Control Devices*. Washington, DC: FHWA.

Federal Highway Administration. 1994. *Selecting Roadway Design Treatments to Accommodate Bicycles*. Washington, DC: FHWA.

Institute of Transportation Engineers. 2002. *Innovative Bicycle Treatments*. Washington, DC: ITE.

National Transit Database. 2002. *National Transit Summaries and Trends*.

Transportation Research Board. 2003. *Access Management Manual*. Washington, DC: TRB.

Transportation Research Board. 2000. *Highway Capacity Manual*. Washington, DC: TRB.

Transportation Research Board. 1986. *NCHRP Report 282: Multilane Design Alternatives for Improving Suburban Highways*. Washington, DC: TRB.

Transportation Research Board. 2003. *NCHRP Report 500: A Guide for Addressing Collisions with Trees in Hazardous Locations*. Washington, DC: TRB.

Rosales, Jennifer. 2007. *Road Diet Handbook: Setting Trends for Livable Streets, Second Edition*. New York, NY: Parsons Brinkerhoff.

United States Access Board. *Accessible Public Rights-of-Way*. <http://www.access-board.gov/prowa/>.

Sources of Additional Information

American Association of State Highway and Transportation Officials. *Guide for the Design and Operation of Pedestrian Facilities*. Washington, DC: AASHTO, 2001.

American Association of State Highway and Transportation Officials. *Roadside Design Guide*. Washington, DC: AASHTO, 2002.

American Association of State Highway and Transportation Officials. *Highway Safety Design and Operations Guide*. Washington, DC: AASHTO, 1997.

American Planning Association. *Bicycle Facility Planning*. APA, 1995.

- City of Eugene. *Arterial Collector Street Plan—Design of Transit Facilities*. Eugene: Department of Public Works, November 1999.
- Metro. *Creating Livable Streets—Street Design Guidelines for 2040, 2nd Edition*. Portland, OR: Portland Metro, 2002.
- City of Los Angeles, Department of Public Works. *Public Agencies Activity Stormwater Guide, Second Edition*. www.lastormwater.org.
- Federal Highway Administration. *Flexibility in Highway Design*. Washington, DC: FHWA, 1997.
- Federal Highway Administration. *Safety Effects of Marked vs. Unmarked Crosswalks at Uncontrolled Locations*. Washington, DC: FHWA, 2002.
- Federal Highway Administration. Characteristics of Emerging Road Users and Their Safety. *FHWA-HRT-04-103*.
- Grand Junction/Mesa County Metropolitan Planning Organization. *Transit Design Standards and Guidelines*.
- Metropolitan Transit Development Board. *Designing for Transit—A Manual for Integrating Public Transportation and Land Development in the San Diego Metropolitan Area*. San Diego: July 1993.
- Texas Transportation Institute. *Guidelines for Planning, Designing and Operating Bus-Related Street Improvements*.
- Tri-Met. *Bus Stops Guidelines*. October 2002.
- American Association of State Highway and Transportation Officials. *Transit Vehicles and Facilities on Streets and Highways (Phase II)*. Future publication.
- Transportation Research Board. *NCHRP Report 330: Effective Utilization of Street Width on Urban Arterials*. Washington, DC: TRB, 1990.
- Transportation Research Board. *NCHRP Synthesis 225: Left-Turn Treatments at Intersections*. Washington, DC: TRB, 1996.
- Transportation Research Board. TCRP 19: *Guidelines for the Location and Design of Bus Stops*, Washington, DC: TRB, 1996.
- Transportation Research Board. Location and Design of Bus Stops, Transit Cooperative Research Program. Washington, DC: TRB, July 1996.
- Transportation Research Board. *TCRP Report 65—Evaluation of Bus Bulbs*. Washington, DC: TRB, 2001.
- Orange County Transportation Authority. *Bus Stop Safety and Design Guidelines*. Kimley-Horn and Associates, Inc., July 2004.
- Oregon DOT. *Design Guidelines for Public Transportation*, 2002.
- Oregon DOT. *Oregon Bicycle and Pedestrian Plan*.
- Urban Land Institute. *Dimensions of Parking, 4th Edition*. Urban Land Institute, 2004.
- Valley Metro, Arizona. *Bus Stop Handbook: Street Improvements for Transit*. Valley Metro (AZ), December 1993.
- Valley Metro, Arizona. *Passenger Facilities Handbook: Off-Street Improvements for Transit*. Valley Metro (AZ), June 1995.
- AC Transit. Designing with Transit: Making Transit Integral to East Bay Communities. www.actransit.org/pdf/designing_with_transit.pdf, 2004.
- Federal Highway Administration. FHWA-PD-94-023. *The National Bicycling and Walking Study—Transportation Choices for a Changing America*; Final Report. Washington, DC, 1994.
- Public Rights-of-Way Access Advisory Committee (PROWAAC). *Special Report: Accessible Public Rights-of-Way: Planning and Designing for Alterations*, 2007.
- California Stormwater Quality Association. *California Stormwater Best Management Practices Handbook for New Development and Redevelopment*. January 2003. www.cabmphandbooks.com.

California Department of Transportation. *Office of Storm Water Management and Design Storm Water Quality Handbook: Project Planning and Design Guide*, May 2007.

City of Portland. *Stormwater Solutions Handbook*. www.portlandonline.com/bes.

City of Portland. *Stormwater Management Manual*. 2004. www.portlandonline.com/bes.

City of Portland. *Green Streets Cross-Bureau Team Report, Phase 1*. March 2006 and *Phase 2*, March 2007. www.portlandonline.com/shared.

Urban, Jim. *Up by Roots: Healthy Soil and Trees in the Built Environment*.



Intersection Design Guidelines

Chapter 10

Sidewalk width appropriate to function of adjacent land use

Farside bus stops with shelter and amenities

On-Street Parking

High visibility crosswalks alternative paving or ladder/zebra striping

ADA Ramps

Introduction

Multimodal intersections operate with pedestrians, bicycles, cars, buses and trucks, and in some cases, trains. The diverse uses of intersections involve a high level of activity and shared space. Intersections have the unique characteristic of accommodating the almost-constant occurrence of conflicts between all modes, and most collisions on thoroughfares take place at intersections. This characteristic is the basis for most intersection design standards, particularly for safety.

Designing multimodal intersections with the appropriate accommodations for all users is performed on a

case-by-case basis. The design extends beyond the immediate intersection and encompasses the approaches, medians, streetside and driveways, and adjacent land uses (**Figure 10.1**). The designer should begin with an understanding of the community objectives and priorities related to design trade-offs such as vehicular capacity and level of service, large-vehicle turning requirements, conflicts, pedestrian and bicycle convenience, accessibility and the efficiency of public transit service. Intersections are perhaps the most sensitive operational component of thoroughfare systems (**Figure 10.2**).

In urban areas, intersections have a significant place-making function as well as a transportation func-

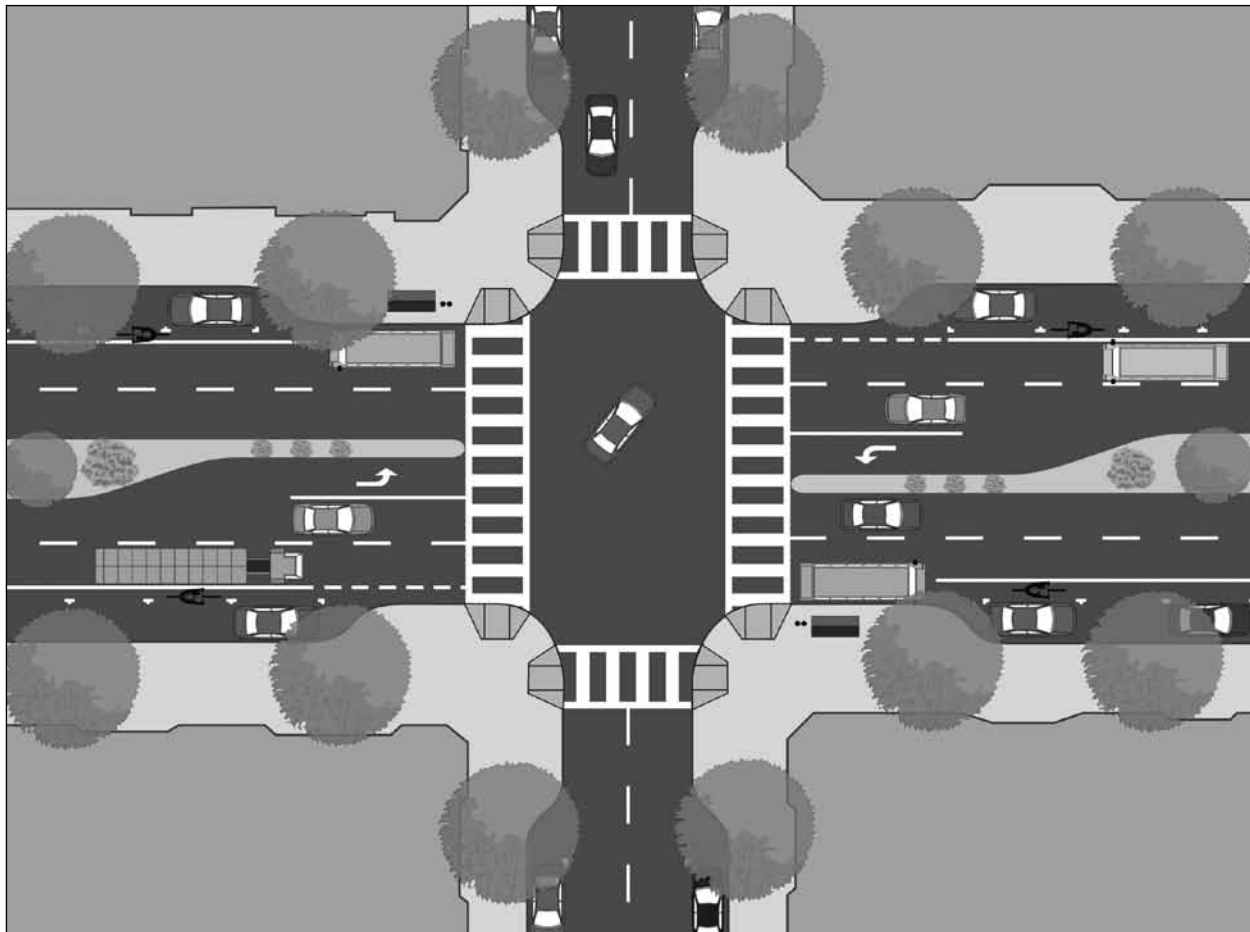

Figure 10.1 The design of intersections encompasses the intersection itself and the approaches to the intersection. It can even affect adjacent land uses. Source: Digital Media Productions.



Figure 10.2 Intersections have the unique characteristic of accommodating the almost-constant occurrence of conflicts between all modes. Source: Texas Transportation Institute.

tion. Significant land uses and architecturally significant buildings are located at intersections and might provide pedestrian access directly from the corners. Intersections may also serve as gateways and are frequently the first thing visitors see when they enter a neighborhood (**Figure 10.3**). It is often requested that the practitioner include aesthetic treatments in intersection design.

Objectives

This chapter:

1. Describes several fundamental aspects of intersection design, including managing multimodal conflicts, sight distance and layout; and
2. Provides general principles, considerations and design guidelines for key intersection components including curb return radii, channelized right turns, modern roundabouts, crosswalks, curb extensions, bicycle lanes and bus stops.

General Principles and Considerations

Intersections are required to meet a variety of user expectations, particularly for users of motor vehi-

cles. Drivers expect to safely pass through intersections with minimal delay and few conflicts. Drivers of large vehicles expect to be able to negotiate turns easily. In urban areas, however, expectations based on rural and suburban experiences are unreasonable. Intersection users in urban areas will experience delays and conflicts between vehicles, pedestrians and bicyclists. Driver expectations need to shift toward taking turns with other modes and a sense of uncertainty, which creates a slower, vigilant and safer environment.

Successful multimodal intersection design is based on several fundamental geometric design and operational principles. These principles include:

- Minimize conflicts between modes (such as signal phasing that separates vehicle movements and pedestrian crossings, bicycle lanes extended to the crosswalk, pedestrian refuge islands, low-speed channelized right turns and so forth.) Provide crosswalks on all approaches.
- Accommodate all modes with the appropriate levels of service for pedestrians, bicyclists, transit and motorists given the recommended speed, volume and expected mix of traffic.



Figure 10.3 Intersections are community gateways. Landscaping in the center island of an intersection. Source: Kimley-Horn and Associates, Inc.



Figure 10.4 Intersections must be accessible to pedestrians with disabilities. This curb extension is equipped with curb ramps and high-contrast detectable warnings. Source: Kimley-Horn and Associates, Inc.

- Avoid elimination of any travel modes due to intersection design. Intersection widening for additional turn lanes to relieve traffic congestion should be balanced against impacts to pedestrians, bicyclists and transit.
- Provide good driver and nondriver visibility through proper sight distance triangles and geometric features that increase visibility, such as curb extensions.
- Minimize pedestrian exposure to moving traffic. Keep crossing distances as short as practical and use operational techniques (protected left-turn signal phasing and prohibited right turn on red) to separate pedestrians and traffic as much as possible.
- Design for slow speeds at critical pedestrian-vehicle conflict points, such as corners, by using smaller curb return radii or low-speed channelized right-turn lanes.
- Avoid extreme intersection angles and break up complex intersections with pedestrian refuge islands. Keep intersections easily and fully comprehensible for all users. Strive for simplicity in intersection design—avoid designing intersections with more than four approaches (or consider a modern roundabout) and keep cross streets as perpendicular as possible.
- Ensure intersections are fully accessible to the disabled and hearing and sight impaired. Provide flush access to crossings, visual and audio

information about WALK/DON'T WALK phases and detectable warnings underfoot to distinguish pedestrian from vehicular areas (**Figure 10.4**).

Considerations regarding intersection design include the following:

- The preferred location for pedestrian crossings is at intersections. However, if the block length exceeds 400 feet, consider adding a midblock crossing. The target spacing for pedestrian crossings in more intensive urban areas (C-4 to C-6) is every 200 to 300 feet.
- Increases in intersection vehicular capacity by adding lanes increase pedestrian wait times and crossing distances, and discourage pedestrian activity and bicycle use. Therefore, consider interconnecting streets in the network, using parallel routes and other strategies before increasing the number of travel lanes beyond the number of lanes recommended in **Table 6.4** in Chapter 6.
- Where possible, facilitate shared cross-access legal agreements between adjacent properties to close and consolidate nonresidential driveways near an intersection. Integrate access management policies and techniques into long-range transportation plans, area plans and design standards.
- If needed to reduce speeds along a thoroughfare, use speed tables or narrower lanes starting on

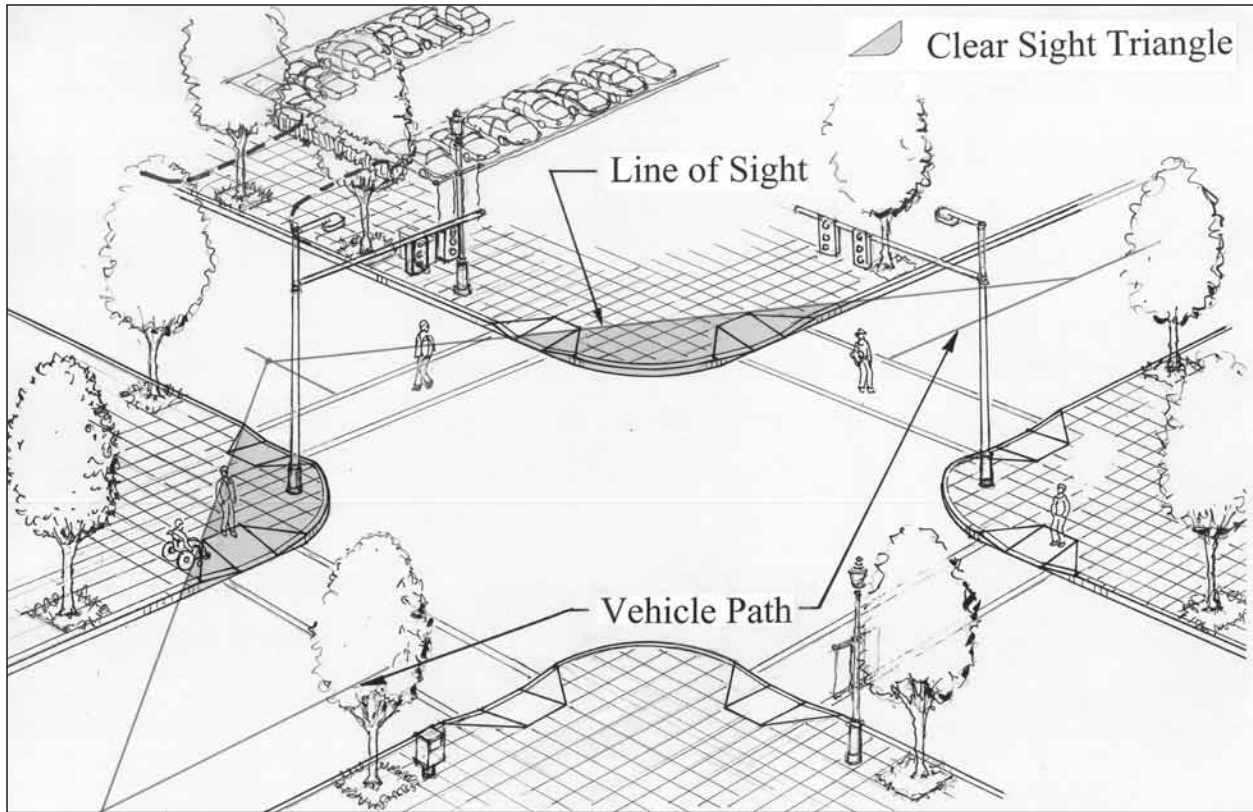

Figure 10.5 Sight distance triangle at intersections. The required sight distance varies with the type of intersection control. Refer to AASHTO Green Book for more details. Source: Kimley-Horn and Associates, Inc.

the approach to intersections, or other speed-management techniques (see Chapter 9 section on Speed Management).

- Traffic control alternatives should be evaluated for each intersection, including stop control, traffic signals and modern roundabouts.
- Design for U-turn movements to facilitate access to property whenever adding a raised median. Use local, state, or the American Association of State Highway and Transportation Officials (AASHTO) guidelines to determine the U-turn radii needs. While local standards vary, it is desirable to use a passenger car as the design vehicle for U-turns on walkable urban thoroughfares.
- The median or the median nose adjacent to a turn lane should extend to the crosswalk. Medians can end prior to the crosswalk for a continuous pedestrian crossing or can extend through the crosswalk if a channel at street grade or a ramp is provided through the median. Median noses extended through the crosswalk provide

a refuge area for pedestrians. Carefully review turning radii of large vehicles that may strike the extended median nose.

Intersection Sight Distance

Specified areas along intersection approaches, called clear sight triangles (shown in **Figure 10.5**), should be free of obstructions that block a driver's view of potentially conflicting vehicles or pedestrians entering the traveled way. The determination of sight triangles at intersections varies by the target speed of the thoroughfares, type of traffic control at the intersection and type of vehicle movement.

In urban areas, intersection corners are frequently entrances to buildings and are desirable locations for urban design features, landscaping and other streetside features. In designing walkable urban thoroughfares, the practitioner works in an interdisciplinary environment and has a responsibility to balance the desire for these streetside features with the provision of adequate sight distance, ensuring safety for all users. In urban

areas, examples of objects that limit sight distance include vehicles in adjacent lanes, parked vehicles, bridge piers and abutments, large signs, poorly pruned trees, tall shrubs and hedges, walls, fences and buildings.

Considerations regarding intersection sight distance include the following:

- Based on AASHTO guidelines, urban traffic controls (e.g., traffic signals, stop signs) alleviate the need for large sight triangles where such controls are employed. Where necessary sight triangles cannot be achieved, target speed, intersection traffic control types, sight line obstructions and/or other design elements should be changed.
- If the sight triangle for the appropriate target speed and intersection control is obstructed, every effort should be made to eliminate or move the obstruction or mitigate the obstruction (for example, install curb extensions to improve visibility of crossing pedestrians, prune street trees to branch height greater than 8 feet, or use lower appurtenances).

Managing Modal Conflict at Intersections

Strategies to eliminate or avoid conflict can result in designs that favor one mode over others. For example, eliminating crosswalks at an urban intersection with a high volume of turning vehicles as a strategy to eliminate conflicts will discourage walking. The practitioner must weigh the ever-present trade-offs between vehicle level of service, large-vehicle accommodation and pedestrian and bicycle connectivity and convenience. For the most part, in urban areas, the trade-offs are clear; every user shares the intersection and equally shares in the benefits and drawbacks of multimodal design.

In locations where the community places a high priority on vehicular level of service, intersection designs should incorporate mitigating measures such as pedestrian countdown signals, pedestrian refuge islands and the replacement of free-flow right turns with low-speed channelized right turns (see applicable section in this chapter).

When improving safety at intersections, it is important that the measures that are used to improve vehicle

traffic flow or reduce vehicle crashes not compromise pedestrian and bicycle safety. Safety aspects need to be identified in an engineering review. The following strategic decisions need to be considered when improving intersection safety design and operation:

- Minimize vehicle-pedestrian conflicts without reducing accessibility or mobility for any user;
- When it is not possible to minimize all conflicts, reduce the exposure of pedestrians and bicyclists to motor vehicle traffic while maintaining a comfortable walking environment; and
- Design intersections so that when collisions do occur, they are less severe.

Traffic engineering strategies can be highly effective in improving intersection safety. These strategies consist of a wide range of devices and operational modifications. Some examples include the following:

- **Addition of left turn lanes at intersections.** Turn lanes are used to separate turning traffic from through traffic. Studies have shown that providing turn lanes for left-turning vehicles can reduce accidents. In walkable urban areas, turn lanes should be limited to a single left-turn lane. The operational benefits of adding turn lanes should be weighed against the increase in pedestrian crossing time.
- **Signals.** Increase the size of signal lenses from 8 to 12 inches to increase their visibility; provide separate signal faces over each lane; install high-intensity signal indications; and change signal timing, including the length of yellow-change and red-clearance intervals. Consider protected left-turn phasing as a strategy to reduce vehicle-pedestrian conflicts.
- **Innovative intersection design.** In appropriate applications, consider innovative intersection designs such as modern roundabouts. Roundabouts reduce speed, eliminate certain types of crashes and lessen the severity of other types of crashes. Examples of an alternate intersection design include “indirect left-turn” intersections, where left turns are accommodated at midblock U-turns to convert left turns to right turns, or “bowtie” intersections where left turns from the major street are directed to nearby roundabouts on the minor street where they make a U-turn

followed by a right turn at the major intersection. Each alternative design has advantages and disadvantages and handles pedestrians and bicyclists differently. The CSS process needs to weigh the trade-offs to select the best alternative.

- **Improve drivers' visibility of pedestrians.** Restrict parking near intersections, properly trim vegetation, move stop lines back from crosswalks by 4 feet, use longitudinal crosswalk striping and use curb extensions.

Design Elements for Intersections in Walkable Areas

Most urban signalized intersections provide basic pedestrian facilities, including crosswalks, pedestrian signal heads, curb ramps and appropriate pedestrian clearance times. Many urban and especially suburban unsignalized intersections are unmarked for pedestrians. Older intersections in walkable urban areas need to be updated to conform to Americans with Disabilities Act (ADA) Public Rights-of-Way Accessibility Guidelines (PROWAG) requirements, better serve bicyclists, improve transit operations, or to simply enhance the pedestrian environment. This section provides a summary of intersection design features the practitioner may want to consider when designing walkable urban intersections.

Uncontrolled Intersections

Common engineering practice is to exclude marked crosswalks from intersections without traffic control approaching the crossing. This is due to a number of factors including avoiding a false sense of security provided by crosswalks when traffic is uncontrolled, encouraging pedestrian caution when legally crossing at intersections without crosswalks, as well as raising liability and maintenance concerns. Indeed, several research studies have shown that pedestrian-vehicle crash rates are higher at unsignalized intersections with marked crosswalks versus those without.

The authors of NCHRP Report 562, *Improving Pedestrian Safety at Unsignalized Intersections*, found that the “safest and most effective pedestrian crossings use several traffic control devices or design elements to meet the information and control needs of both motorists and pedestrians.” The NCHRP study and other research

has found that marked crosswalks alone are insufficient and, when used, should be used in conjunction with other measures depending on the circumstances. In combination with marked crossings, measures to enhance uncontrolled intersections include:

- High visibility crosswalk markings such as longitudinal bars;
- A median refuge island (minimum of 6 feet) to make the street crossing in stages and more convenient;
- Street and crosswalk illumination;
- Advanced yield lines to improve the visibility of crossing pedestrians and reduce “multiple threat” type crashes;
- Installation of curb extensions to shorten crossing distance and improve driver and pedestrian visibility;
- Installation of pedestrian-activated flashing beacons to warn motorists of crossing pedestrians;
- Motorist signs to indicate that pedestrians have the legal right of way, “YIELD TO PEDESTRIANS,” “STOP HERE FOR PEDESTRIANS,” or internally illuminated pedestrian crossing signs; and
- Pedestrian signs or median designs (“Z” crossings) that encourage or facilitate looking for potential conflicts.

Signalized Intersections

Signalized intersections, while providing some level of pedestrian protection by controlling traffic, have many available design features that increase pedestrian visibility, information and convenience. These features are listed in **Table 10.1**.

Design Guidance

Intersection Geometry

This section provides general principles, considerations and guidelines on the geometric layout of urban at-grade multimodal intersections and the key components that comprise geometric and operational design. These guidelines include a section on the application and design of modern roundabouts as an alternative to the conventional intersection.

Table 10.1 Pedestrian and Bicycle Features at Signalized Intersections

<p>Shorter and more visible crosswalks</p>	<ul style="list-style-type: none"> • Crosswalks on all approaches; • Longitudinal markings (possible use of colored and/or textured paving); • Reduced overall street widths by reducing the number of travel and turn lanes, or narrowing travel lanes; • Curb extensions with pedestrian push buttons on extensions; and • Median refuges on wide streets (greater than 60 feet) with median push buttons.
<p>Priority for pedestrians, bicyclists, and accessibility</p>	<ul style="list-style-type: none"> • Shorter cycle lengths, meeting minimum pedestrian clearances (also improves transit travel times); • Longer pedestrian clearance times (based on 3.5 feet/sec. to set flashing (clearance) time and 3.0 feet/sec for total crossing time); • Reduced conflicts between pedestrians and turning vehicles achieved with: <ul style="list-style-type: none"> • Pedestrian lead phases; • Scramble phases in very high pedestrian volume locations; • Restricted right turns on red when pedestrians are present during specified hours; and • Allowing right turns during cross-street left turn phases reduces the number of right turn conflicts during pedestrian crossing phase.
<p>Low speed channelized right turn lanes</p>	<ul style="list-style-type: none"> • Adequate sized islands for pedestrian refuge; • Raised pedestrian crossing/speed table within channelized right turn lane; and • Signal control of channelized right turn in high pedestrian volume locations.
<p>Improved pedestrian information</p>	<ul style="list-style-type: none"> • Pedestrian countdown timers; and • “Look Before Crossing” markings or signs.
<p>Bicycle features</p>	<ul style="list-style-type: none"> • Bicycle lanes striped up to crosswalk (using “skip lines” if vehicular right turns are allowed); • Bicycle detectors on high volume routes, or bicyclist-accessible push buttons; • Adequate clearance interval for bicyclists; • Colored paving in bicycle/vehicle lanes in high-conflict areas; and • “Bike Boxes” (painted rectangle along right hand curb or behind crosswalk) to indicate potential high-conflict area between bicycles continuing through an intersection and right turning vehicles, and to allow bicyclists to proceed through intersection or turn in advance of vehicles.
<p>High-priority transit thoroughfare elements</p>	<ul style="list-style-type: none"> • Adaptive Transit Signal Priority (TSP) when transit detected; • Extended green phase on bus route (rapid transit signal priority); • Truncated green phase for cross street; • Re-order phasing to provide transit priority (transit priority not to be given in two successive cycles to avoid severe traffic impacts); • Other bus priority signal phasing (sequencing) • Queue jump lanes and associated signal phasing; and • Curb extension bus stops, bus bulbs.
<p>Accessibility and space for pedestrians</p>	<ul style="list-style-type: none"> • Properly placed pedestrian actuation buttons, with audible locator tones; • Detectable warnings; • Two curb ramps per corner depending on radius of curb return and presence of curb extensions; • Clear pedestrian paths (and shoulder clearances) ensuring utilities and appurtenances are located outside pedestrian paths; • Vertical and overhang clearance of street furnishings for the visually impaired; • Properly placed signal poles and cabinets: <ul style="list-style-type: none"> • Behind sidewalks (in landscaping or in building niches); • In planting strips (furnishings zone); and • In sidewalk or curb extensions, at least three feet from curb ramps.
<p>Traffic operations for safe speeds and pedestrian convenience</p>	<ul style="list-style-type: none"> • Target speeds between 25–35 mph; • Signal progression at target speeds; and • Fewer very long/very short cycle lengths.
<p>Higher priority on aesthetics</p>	<ul style="list-style-type: none"> • Textured and colored material within the streetside; • Colored material within crosswalks, but avoid coarse textures which provide rough surfaces for the disabled; • Attractive decorative signal hardware, or specialized hardware; and • Attention to landscaping and integration with green street stormwater management techniques.

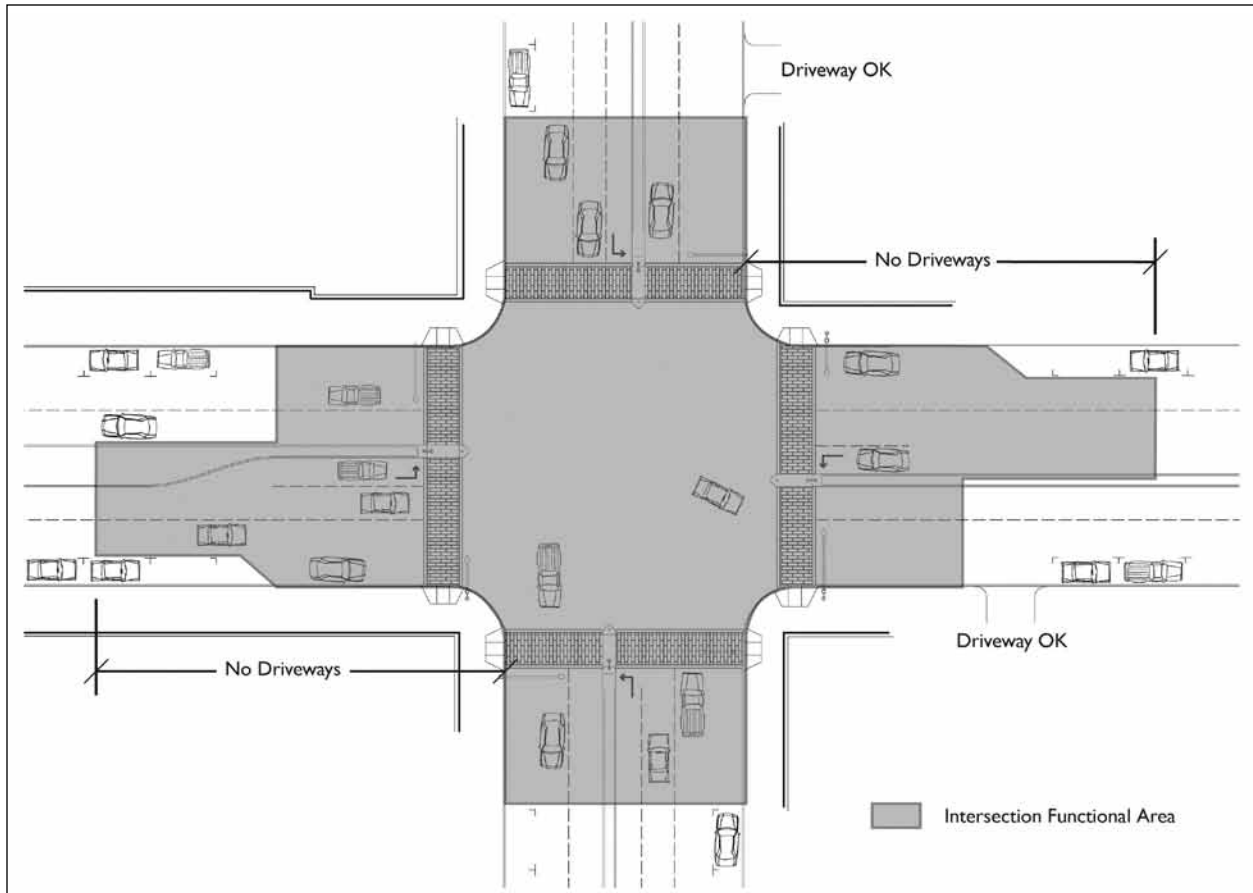

Figure 10.6 Many decisions are made within the functional area of an intersection.
Source: Community, Design + Architecture.

General Intersection Layout

Intersection layout is primarily composed of the alignment of the legs; width of traffic lanes, bicycle lanes, crosswalks, and sidewalks on each approach; number of lanes, median and streetside elements; and the method of treating and channelization of turning movements. Like the design of the thoroughfare's cross-section, the design of an intersection's layout requires a balance between the needs of pedestrians, bicyclists, vehicles, freight and transit in the available right of way. Beyond intersection layout, the practitioner needs to work with a multidisciplinary team to address accessibility, traffic control and placement of equipment, traffic operations, lighting (safety and pedestrian scaled), landscaping and urban design.

Intersection Fundamentals

Intersections are composed of a physical area—the area encompassing the central area of two intersect-

ing streets as shown in **Figure 10.6**. The functional area is where drivers make decisions and maneuver into turning movements. The three parts of the functional area include (1) the perception-reaction distance, (2) maneuver distance and (3) storage distance. AASHTO's *A Policy on Geometric Design of Highways and Streets* (2004a) addresses the issues and provides guidance for the detailed geometric design of the functional area.

The basic types of intersections in urban contexts include the T-intersection (a three-leg intersection), cross-intersection (four-leg intersection), multileg intersection (containing five or more legs) and the modern roundabout, which is discussed later in this chapter.

Intersection Conflicts

Intersections, by their very nature, create conflicts between vehicles, pedestrians and bicyclists. **Figure 10.7** illustrates the number of conflicts between different

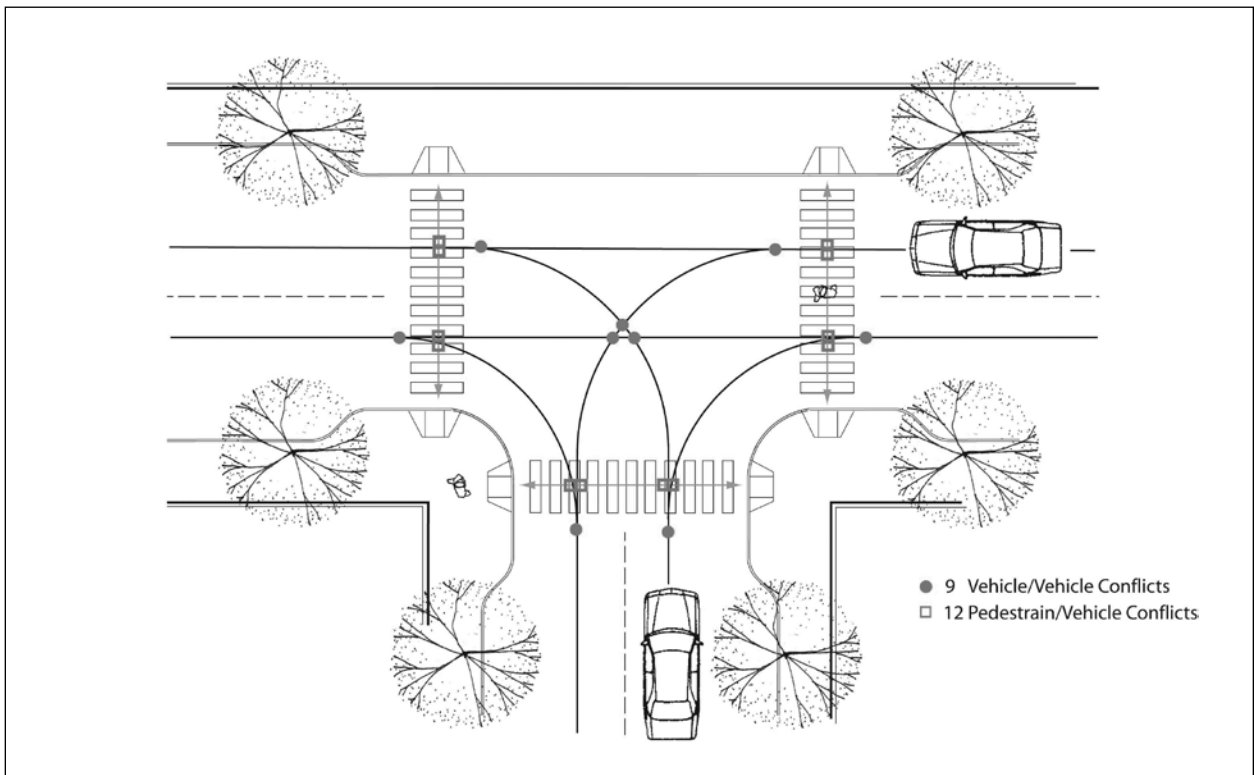
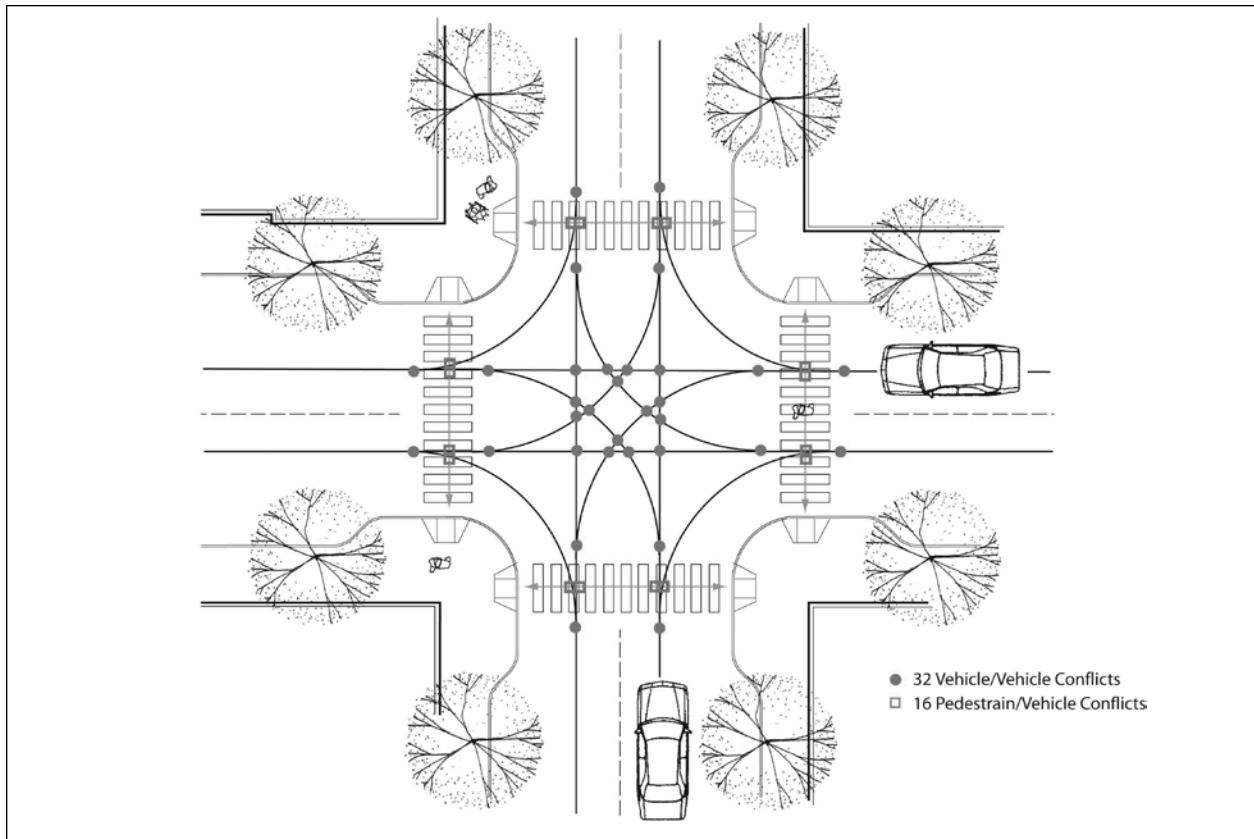

Figure 10.7 Vehicle and pedestrian conflicts at three- and four-leg intersections. Source: Community, Design + Architecture, adapted from an illustration by Michael Wallwork.

modes at three- and four-leg intersections. According to AASHTO's *Guide for the Planning, Design and Operation of Pedestrian Facilities* (2004b), the following are principles of good intersection design for pedestrians:

- **Clarity**—making it clear to drivers that pedestrians use the intersections and indicating to pedestrians where the best place is to cross;
- **Predictability**—drivers know where to expect pedestrians;
- **Visibility**—good sight distance and lighting so that pedestrians can clearly view oncoming traffic and be seen by approaching motorists;
- **Short wait**—providing reasonable wait times to cross the street at both unsignalized (via gaps created in traffic or two-stage crossings) and signalized intersections (via signal cycle length);
- **Adequate crossing time at signalized intersections**—the appropriate signal timing for all types of users to cross the street;
- **Limited exposure**—reducing conflict points where possible, reducing crossing distance and providing refuge islands when necessary; and
- **Usable crossing**—eliminating barriers and ensuring accessibility for all users.

General Principles and Considerations

General principles and considerations for the design of intersection layouts include the following:

- Intersections should be designed as compact as practical in urban contexts. Intersections should minimize crossing distance, crossing time and exposure to traffic and should encourage pedestrian travel.
- A design speed appropriate for the context. Motorists traveling at slower speeds have more time to perceive and react to conflicts at intersections.
- Intersection approaches should permit motorists, pedestrians and bicyclists to observe and react to each other. Intersection approaches should, therefore, be as straight and flat as possible, and adequate sight distances should be maintained.

- Avoid providing very short radius horizontal curves approaching the major street to mitigate acute approach alignments, as motorists might encroach into opposing travel lanes at such curves.
- Avoid placing intersections on sharp horizontal or vertical curves where sight distances may be reduced. Intersections should not be placed on either end of a curve unless sufficient sight distance is available.
- Functional areas of adjacent intersections should not overlap.
- Channelizing islands to separate conflicts are important design elements within intersection functional areas. These include properly designed channelized right turns (see section on right-turn channelization in this chapter).
- Intersections that accommodate fixed-guideway transit have special challenges (see section on Transit Design in Chapter 9).

Curb Return Radii

Background and Purpose

Related Thoroughfare Design Elements

- Transit design
- On-street parking and configuration
- Right-turn channelization
- Pedestrian refuge islands
- Bicycle lanes

Curb returns are the curved connection of curbs in the corners formed by the intersection of two streets. A curb return's purpose is to guide vehicles in turning corners and separate vehicular traffic from pedestrian areas at intersection corners. The radius of the curve varies, with larger radii used to facilitate the turning of large trucks and buses. Larger radius corners increase the length of pedestrian crosswalks, and increase vehicular turning speeds.

In designing walkable urban thoroughfares, the smallest practical curb-return radii are used to shorten the length of the pedestrian crosswalks. Based on this function, this report suggests a general strategy for selecting curb-return radii design criteria and discusses situations requiring larger design vehicles. The primary benefits of smaller curb-return radii to pedestrians in urban areas include:

- Increasing motorist visibility of pedestrians waiting to cross the street;
- Reducing pedestrian crossing distance (which also benefits vehicles with a shorter cycle length at signalized intersections) and exposure to traffic;
- Providing the shortest accessible route for disabled persons as required under ADA; and
- Reducing speed of turning vehicles and severity of crashes if they occur.

General Principles and Considerations

General principles and considerations regarding curb return radii include the following:

- In walkable areas, the first consideration is keeping crossing distance as short as possible. Consider alternatives to lengthening the curb radius first, then consider lengthening the radius if no other alternative exists.
- Curb-return radii should be designed to accommodate the largest vehicle type that will frequently turn the corner (sometimes referred to as the design vehicle). This principle assumes that the occasional large vehicle can encroach into the opposing travel lane as shown in **Figure 10.8**. If encroachment is not acceptable, alternative routes for large vehicles should be identified.
- Curb-return radii should be designed to reflect the “effective” turning radius of the corner. The effective turning radius takes into account the wheel tracking of the design vehicle utilizing the width of parking and bicycle lanes. Use of the effective turning radii allows a smaller curb-return radius while retaining the ability to accommodate larger design vehicles (**Figure 10.9**).

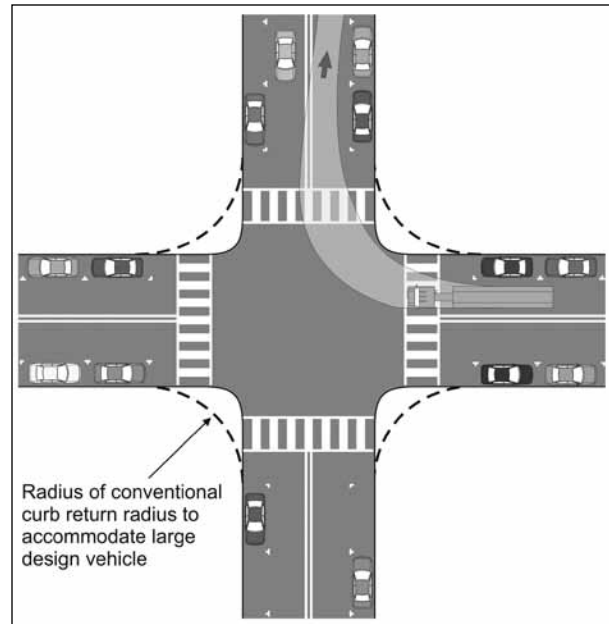

Figure 10.8 Smaller curb-return radii shorten the distance that pedestrians must cross at intersections. The occasional turn made by large trucks can be accommodated with slower speeds and some encroachment into the opposing traffic lanes. Source: Kimley-Horn and Associates, Inc.

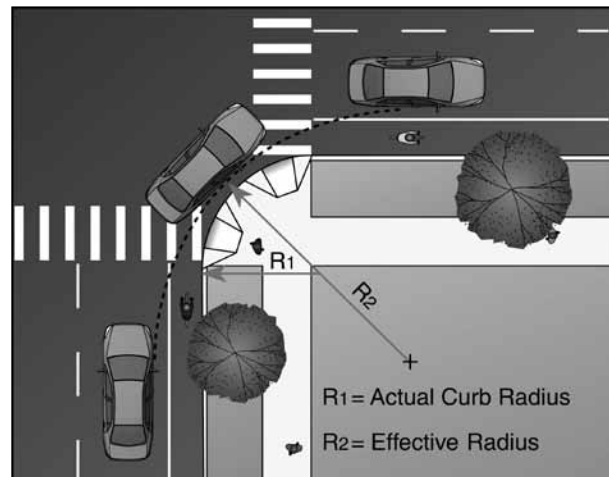

Figure 10.9 The existence of parking and bicycle lanes creates an “effective” turning radius that is greater than the curb-return radius. Source: Kimley-Horn and Associates, Inc., adapted from the *Oregon Bicycle and Pedestrian Plan*.

- In urban centers (C-5) and urban cores (C-6) where pedestrian activity is intensive, curb-return radii should be as small as possible.
- On multilane thoroughfares, large vehicles may encroach entirely into the adjacent travel lanes (in the same direction of travel).

- To help select a design vehicle, identify bus routes to determine whether buses are required to turn at the intersection. Also check transit service plans for anticipated future transit routes. Map existing and potential future land uses along both streets to evaluate potential truck trips turning at the intersection.
 - Curb-return radii of different lengths can be used on different corners of the same intersection to match the design vehicle turning at that corner. Compound, spiral, or asymmetrical curb returns can be used to better match the wheel tracking of the design vehicle (see the AASHTO Green Book for the design of spiral and compound curves).
 - If large vehicles need to encroach into an opposing travel lane, consider placing the stop line for opposing traffic further from the intersection.
 - The designer must consider lane widths, curb radii, locations of parking spaces, grades and other factors in designing intersections. Designers are discouraged from using combinations of minimum dimensions unless the resulting design can be demonstrated to be operationally practical and safe.
- A curb return radius of 5 to 15 feet should be used where:
 1. High pedestrian volumes are present or reasonably anticipated;
 2. Volumes of turning vehicles are low;
 3. The width of the receiving intersection approach can accommodate a turning passenger vehicle without encroachment into the opposing lane;
 4. Large vehicles constitute a very low proportion of the turning vehicles;
 5. Bicycle and parking lanes create additional space to accommodate the “effective” turning radius of vehicles;
 6. Low turning speeds are required or desired; and
 7. Occasional encroachment of turning school bus, moving van, fire truck, or oversized delivery truck into an opposing lane is acceptable.
 - Curb radii may need to be larger where:
 1. Occasional encroachment of a turning bus, school bus, moving van, fire truck, or oversized delivery truck into the opposing lane is not acceptable;
 2. Curb extensions are proposed or might be added in the future; and
 3. Receiving thoroughfare does not have parking or bicycle lanes and the receiving lane is less than 12 feet in width.

Recommended Practice

Flexibility in the design of curb return radii revolves around the need to minimize pedestrian crossing distance, the choice of design vehicle, the combination of dimensions that make up the effective width of the approach and receiving lanes and the curb return radius itself. The practitioner needs to consider the trade-offs between the traffic safety and operational effects of infrequent large vehicles and the creation of a street crossing that is reasonable for pedestrians. The guidelines assume arterial and collector streets in urban contexts (C-3 to C-6) with turning speeds of city buses and large trucks of 5 to 10 mph. The guidance is not applicable to intersections without curbs.

Recommended practices include the following:

- In urban centers (C-5) and urban cores (C-6) at intersections with no vehicle turns, the minimum curb return radii should be 5 feet.

An alternative to increasing curb-return radii is setting back the stop line of the receiving street to allow large vehicles to swing into opposing lane as they turn. However, setbacks to accommodate right-turn encroachment need to be examined on a case-by-case basis since very tight right turns may require long setbacks.

Recommendations for Curb Radii on Transit and Freight Routes

Truck routes should be designated outside of or on a minimum number of streets in walkable areas to reduce the impact of large turning radii. Where designated local or regional truck routes conflict

with high pedestrian volumes or activities, analyze freight movement needs and consider redesignation of local and regional truck routes to minimize such conflicts.

On bus and truck routes, the following guidelines should be considered:

- Curb-return radii design should be based on the effective turning radius of the prevailing design vehicle.
- Where the potential for conflicts with pedestrians is high and large vehicle turning movements necessitate curb radii exceeding 50 feet, evaluate installation of a channelized right-turn lane with a pedestrian refuge island (see the section on pedestrian refuge islands in Chapter 9 and the section on channelized right-turn lanes in Chapter 10). To better accommodate the path of large vehicles use a three-centered compound curve in the design of the island (see the AASHTO Green Book's Chapter 9 for design guidance).
- Where frequent turning of large vehicles takes place, avoid inadequate curb-return radii as they could potentially cause large vehicles to regularly travel across the curb and into the pedestrian waiting area of the streetside.

Justification

Intersections designed for the largest turning vehicle traveling at significant speeds with no encroachment result in long pedestrian crossings and potentially high-conflict areas for pedestrians and bicyclists. Radii designed to accommodate the occasional large vehicle will allow passenger cars to turn at high speeds. In designing walkable urban thoroughfares, the selection of curb returns ranging from 5 to 25 feet in radius is preferable to shorten pedestrian crossings and slow vehicle-turning speeds to increase safety for all users.

Channelized Right-Turns

Background and Purpose

Related Thoroughfare Design Elements

- Curb return radii
- Crosswalks
- Bicycle lanes at intersections
- Transit design

In urban contexts, high-speed channelized right turns are generally inappropriate because they create conflicts with pedestrians and bicyclists and also increase turning speeds. Under some of the circumstances described below, providing channelized right-turn lanes on one or more approaches at a signalized intersection can be beneficial, but unless designed correctly, these right-turn lanes can be undesirable for pedestrians. According to the *Oregon Bicycle and Pedestrian Plan* a well-designed channelization island can:

- Allow pedestrians to cross fewer lanes at a time and judge conflicts separately;
- Provide refuge for slower pedestrians;
- Improve accessibility to pedestrian push-buttons; and
- Reduce total crossing distance, which provides signal-timing benefits.

Right-turning drivers may not have to stop for the traffic signal when a channelized right-turn lane is provided. Even where pedestrian signal heads are provided at the intersection, pedestrians are usually expected to cross channelized right-turn lanes without the assistance of a traffic signal. Most channelized right-turn lanes consist of only one lane, and the crossing distance tends to be relatively short. However, drivers are usually looking to their left to merge into cross-street traffic and are not always attentive to the presence of pedestrians.



Figure 10.10 A channelized right-turn lane typically provides a pedestrian refuge island and an uncontrolled crosswalk. Source: Dan Burden, walklive.org.

General Principles and Considerations

The general principles and considerations regarding channelized right turns include the following:

- Avoid using channelized right-turn lanes where pedestrian activity is or is expected to be significant. If a channelized right-turn lane is unavoidable, use design techniques described in this report to lessen the impact on pedestrians.
- Exclusive right-turn lanes should be limited. A right-turning volume threshold of 200–300 vehicles per hour is an acceptable range for the provision of right-turn lanes. Once determined that a right-turn lane is necessary, a well-designed channelization island can help slow down traffic and separate conflicts between right-turning vehicles and pedestrians (**Figure 10.10**).
- If channelized right-turn lane is justified, design it for low speeds (5 to 10 mph) and high-pedestrian visibility.
- For signalized intersections with significant pedestrian activity, it is highly desirable to have pedestrians cross fully under signal control. This minimizes vehicle-pedestrian conflicts and adds to the comfort of pedestrians walking in the area.

Recommended Practice

Recommended practices regarding channelized right-turn lanes include the following:

- The provision of a channelized right-turn lane is appropriate only on signalized approaches where right-turning volumes are high or large vehicles frequently turn and conflicting pedestrian volumes are low and are not expected to increase greatly.
- Where channelized right-turn lanes already exist at a high-pedestrian-activity signalized intersection, pedestrians can best be served by installing pedestrian signals to the right-turn lane crossing. This enables the pedestrian to cross the legs of the intersection fully under signalized control.
- Removing channelized right-turn lanes also makes it possible to use signing, such as NO TURN ON RED, turn-prohibition signs, or exclusive pedestrian signal phases to further assist pedestrians in safely crossing the street.
- When channelized right-turn lanes are justified for traffic capacity or large vehicle purposes, the following practices should be used:
 - Provide a low-angle right turn (about 112 degrees). This angle slows down the speed of right-turning vehicles and improves driver visibility of pedestrians within and approaching the crosswalk (**Figure 10.11**).
 - Use longitudinal crosswalk striping for visibility and place crosswalks so that a motorist has a clear view of pedestrians.
 - A well-illuminated crossing point should be placed where drivers and pedestrians have good sight distance and can see each other in advance of the crossing point. Unless no other choices are available, the crossing point should not be placed at the point where right-turning drivers must yield to other vehicles and therefore might not be watching for pedestrians.
 - Provide accessible islands. The island that forms the channelized right-turn lane must be a raised island of sufficient size (at least 120 square feet) for pedestrians to safely wait in a position where they are at least

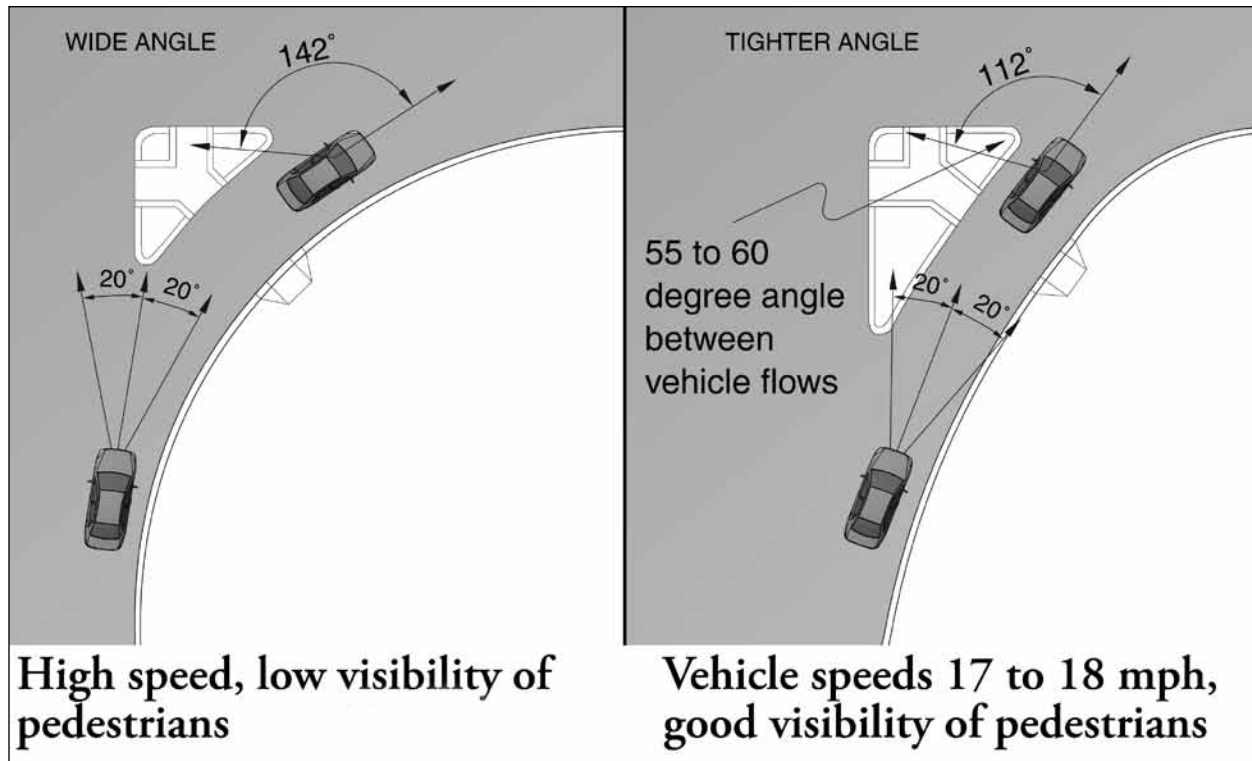

Figure 10.11 The preferred design of a channelized right-turn lane uses an approach angle that results in a lower speed and improved visibility. Source: Kimley-Horn and Associates, Inc., adapted from an illustration by Dan Burden.

4 feet from the face of curb in all directions. A painted island is not satisfactory for pedestrians. The island also has to be large enough to accommodate accessible features, such as curb ramps (usually in three separate directions) or channels cut through the raised island that are flush with the surrounding pavement. If the crossing of the right-turn lane is signalized, the island needs to be large enough to contain pedestrian push buttons.

- Unless the turning radii of large vehicles, such as tractor-trailers or buses must be accommodated, the pavement in the channelized right-turn lane should be no wider than 16 feet. For any width right-turn lane, mark edge lines and cross-hatching to restrict the painted width of the travel way of the channelized right-turn lane to 12 feet to slow smaller vehicles.

- If vehicle-pedestrian conflicts are a significant problem in the channelized right-turn lane, it might be appropriate to provide signing to remind drivers of their legal obligation to yield to pedestrians crossing the lane in the marked crosswalk. Regulatory signs such as the TURNING TRAFFIC MUST YIELD TO PEDESTRIANS (R10-15) or warning signs such as the PEDESTRIAN CROSSING (W11-2) could be placed in advance of or at the crossing location.
- Signalize the channelized right-turn movement to eliminate significant vehicle-pedestrian conflicts. Signalization may be provided when there is/are (1) multiple right-turning lanes; (2) something inherently unsafe about the unsignalized crossing, such as poor sight distance or an extremely high volume of high-speed right-turning traffic; or (3) high pedestrian-vehicle crash experiences.

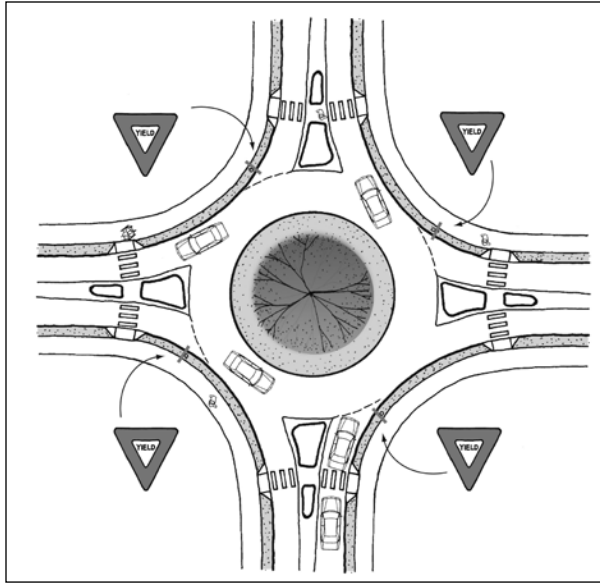

Figure 10.12 A typical single-lane modern roundabout design provides yield control on all approaches and deflects approaching traffic to slow speeds. Source: Community, Design + Architecture, adapted from an illustration in *Roundabouts, An Informational Guide* (FHWA).

Modern Roundabouts

Background and Purpose

Related Thoroughfare Design Elements

- Pedestrian refuge islands
- Transit design
- Bicycle treatments at intersections
- Bus stops at intersections
- Bicycle lanes

Modern roundabouts are an alternative form of intersection control that is becoming more widely accepted in the United States. In the appropriate circumstances, significant benefits can be realized by converting stop-controlled and signalized intersections into modern roundabouts. These benefits include improved safety, speed reduction, reduction in certain types of vehicle crashes, opportunities for aesthetics and urban design, and operational functionality and capacity.

Studies conducted in the United States and published by the Federal Highway Administration in *Roundabouts: An Informational Guide* (2000) indicate that modern single-lane roundabouts in urban areas can result in up to a 61 percent reduction in all crashes and a 77 percent reduction in injury crashes when compared with stop-controlled intersections. When signalized intersections are replaced by modern single-lane roundabouts in urban areas, they have resulted in up to a 32 percent reduction in all crashes and up to a 68 percent reduction in injury crashes.

There remain some concerns regarding roundabouts and pedestrian and bicycle safety and how the disabled are accommodated. Care should be taken in areas with particularly high pedestrian volumes to provide adequate crosswalk widths and island dimensions to serve the volume of pedestrians moving around the roundabout. Double-lane roundabouts are of particular concern to pedestrians with visual impairments and bicyclists.

General Principles and Considerations

The purpose of a modern roundabout is to increase vehicle capacity at the intersection, slow traffic and reduce the severity of collisions. They are not generally used to enhance pedestrian and bicycle safety. Roundabouts are not always the appropriate solution. General principles and considerations for the design of modern roundabouts include the following:

- The application of roundabouts requires close attention to a number of issues, including:
 - Type of design vehicle;
 - Use by disabled and visually impaired persons; and
 - Effects on pedestrian route directness.
- A modern roundabout should be designed to reduce the relative speeds between conflicting traffic streams and the absolute speed of vehicles to improve pedestrian safety. The curved path that vehicles must negotiate slows the traffic. Vehicles entering need to be properly deflected and yield to traffic already in the circulating roadway of the roundabout (**Figure 10.12**).

- Selecting a roundabout as the appropriate traffic control for an intersection requires location-specific analysis. Intersections with more than four legs are also good candidates for conversion to modern roundabouts, as are streets intersecting at acute angles.
- Locating pedestrian crossings at least 25 feet from the roundabout entry point.
- Accommodating bicyclists by (1) preferably mixing with the flow of vehicular traffic (but without pavement markings delineating a bicycle lane) or (2) alternatively, use of a slip ramp from the street to the sidewalk proceeding around the intersection along separate paths, which is usually combined with pedestrian facilities. This situation can create conflicts between bicyclists and pedestrians that must be addressed through good design and signage, and it is inconvenient for the bicyclist. To accommodate different ability levels of bicyclists, both options could be implemented at the same roundabout unless specific conditions warrant otherwise.
- Single-lane roundabouts (**Figure 10.13**) may typically accommodate up to 20,000 entering vehicles per day, depending on a location-specific analysis. A double-lane roundabout typically accommodates up to 40,000 vehicles per day. Capacity analyses should be conducted to determine peak hour operating conditions and levels of service. Specific dimensions need to accommodate such volumes, as are determined using roundabout analysis tools. Refer to *Roundabouts: An Informational Guide* (FHWA 2000) for more information.
- If considering a double-lane roundabout on a boulevard, carefully evaluate pedestrian crossings. It may be desirable to provide crosswalks at midblock locations away from the roundabout. Double-lane roundabouts are not recommended in areas with high levels of pedestrian and bicycle activity.
- Intersections near active railroad-grade crossings are typically not good candidates for roundabouts since traffic would be blocked in all directions when trains are present.



Figure 10.13 Typical layout of a single lane modern roundabout. Source: Kimley-Horn and Associates, Inc.

- Sight distance for drivers entering the roundabout should be maintained to the left so that drivers are aware of vehicles and bicycles in the circle. Visibility across the center of the circle is not critical.
- Roundabouts provide an opportunity to visually enhance the area. Appropriate landscaping is encouraged, even in the center island. However, for safety, pedestrians are not permitted to walk to the center island. Thus, water features or features that might attract pedestrians to the center island should be discouraged.
- Proper signing and pavement markings should be designed for motorists, bicyclists and pedestrians in advance of and at the location of the roundabout. Consideration should be given to the use of a “yield line” where appropriate, as per Section 3B.16 of the *Manual on Uniform Traffic Control Devices* (MUTCD) (FHWA 2009).
- At some locations, pedestrian volumes may be high enough to warrant signal control of roundabout approaches to provide gaps for vehicles (since pedestrians have the right of way). Pedestrian-demand signals may be required at multilane roundabout crossings in order to create and identify gaps for some types of pedestrians: for example, children, the elderly and people who have visual or cognitive impairments.

Recommended Practice

Table 10.2 provides guidance for the selection of modern roundabouts for various thoroughfare types and presents general design parameters. There are three general roundabout design philosophies in use in the United States. First, many older traffic circles and rotaries are being eliminated or redesigned to modern roundabouts. Second, the Australian model of smaller-diameter and slower speed roundabouts is gaining popularity in the United States, as is the third, the British model of larger-diameter, multilane, higher-speed roundabouts. The designer should reference the planning

section of FHWA's informational guide to aid in the decision-making process.

Justification

Roundabouts exist at more than 15,000 intersections in Europe and Australia, with decades of successful operation, research and improvements. Introduced into the United States in the 1990s, modern roundabouts are much improved over older American traffic circles and rotaries. Significant benefits related to crash and delay reduction are cited by researchers based on conversion of four-way stop-controlled and signal-controlled intersections in eight states.

Table 10.2 Recommended Practice for Modern Roundabouts

Parameter	Minimum "Mini-Roundabout"	Urban Compact Roundabout	Urban Single-Lane Roundabout	Urban Double-Lane Roundabout*
Maximum Entry Speed (mph)	15	15	20	25
Design Vehicle	Bus and single-unit truck drive over apron	Bus and single-unit truck	Bus and single-unit truck WB-50 with lane encroachment on truck apron	WB-67 with lane encroachment on truck apron
Inscribed circle diameter (feet)	45 to 80	80 to 100	100 to 130	150 to 180
Maximum number of entering lanes	1	1	1	2
Typical capacity (vehicles per day entering from all approaches)	10,000	15,000	20,000	40,000
Applicability by Thoroughfare Type:				
Boulevard	Not Applicable	Not Applicable	Not Applicable	Applicable
Arterial Avenue	Not Applicable	Not Applicable	Applicable	Applicable
Collector Avenue	Applicable	Applicable	Applicable	Not Applicable
Street	Applicable	Applicable	Applicable	Not Applicable

* Note the pedestrian and bicycle conflicts are inherent in multilane roundabouts unless they are signalized.

Pedestrian Treatments at Intersections—Crosswalks

Background and Purpose

Related Thoroughfare Design Elements

- Midblock crossings
- Channelized right turns
- Curb extensions
- Curb-return radii
- Modern roundabouts
- Pedestrian refuge islands

Crosswalks are used to assist pedestrians in crossing streets. The definition provided in the MUTCD of an unmarked crosswalk makes it clear that unmarked crosswalks can exist only at intersections, whereas the definition of a marked crosswalk makes it clear that marked crosswalks can exist at intersections “or elsewhere.” Crosswalks also provide the visually impaired with cues and wayfinding, as long as they have appropriate contrast.

If sidewalks exist on one or more quadrants of the intersection at a signalized or unsignalized intersection, then crosswalks are legally present at the intersection whether they are marked or not. Even if sidewalks do not exist at the intersection, in some states crosswalks may be legally present.

Even if unmarked crosswalks legally exist at a signalized intersection, it is almost always beneficial to provide marked crosswalks from the perspective of pedestrian safety. Marked crosswalks alert drivers approaching and traveling through the intersection of the potential presence of pedestrians. Marked crosswalks also direct legal pedestrian movements to desirable crossing points.

If an unmarked crosswalk legally exists across a stop-controlled approach to an intersection, it is usually

not necessary to mark the crosswalk. However, if engineering judgment determines that pedestrian safety or the minimization of vehicle-pedestrian conflicts is especially important, then providing a marked crosswalk along with advanced warning signs and markings would be appropriate.

General Principles and Considerations

In designing thoroughfares, the issue of crosswalks is not isolated to an individual intersection. The intent of CSS in walkable areas is to create an environment in which pedestrians and bicycles are expected and to support this expectation with consistent and uniform application of signing, markings and other visual cues for motorists and pedestrians. The following principles and considerations should help guide the planning or design of pedestrian crossings:

- Assume that pedestrians and bicyclists want and need safe access to all destinations that are accessible to motorists. Additionally, pedestrians will want to have access to destinations not accessible to motorists.
- Typical pedestrian and bicyclist generators and destinations include residential neighborhoods, schools, parks, shopping areas and employment centers. Most transit stops require that pedestrians be able to cross the street.
- Pedestrians need safe access at many uncontrolled locations, including intersections and midblock locations.
- Pedestrians must be able to cross streets at regular intervals. Unlike motor vehicles, pedestrians should not be expected to go more than 300 to 400 feet out of their way to take advantage of a controlled intersection.
- Intersections provide the best locations to control motorized traffic to permit pedestrian crossings.
- In order to effectively indicate to motorists that they are in, or approaching, a pedestrian area and that they should expect to encounter pedestrians crossing the street, the design of the crosswalk must be easily understood, clearly visible

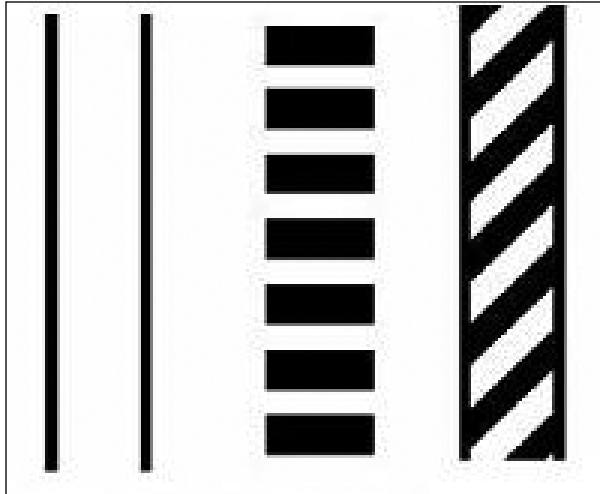

Figure 10.14 The three primary types of crosswalk markings (from left to right) are transverse, longitudinal and diagonal. Source: Kimley-Horn and Associates, Inc.



Figure 10.15 Crosswalks with colored bricks contrast with concrete pavement. However, over time, colored bricks stain and lose contrast. Painted stripes marking brick or colored concrete crosswalks would increase their visibility. Otherwise use standard crosswalk markings for long-term visibility. Source: Kimley-Horn and Associates, Inc.

and incorporate realistic crossing opportunities for pedestrians.

- There are three primary marking options: transverse, longitudinal and diagonal (zebra) lines (**Figure 10.14**). The placement of lines for longitudinal markings should avoid normal wheel paths, and line spacing should not exceed 2.5 times the line width.
- At unsignalized or uncontrolled crossings, special emphasis longitudinal or diagonal markings should be used to increase visibility. High-contrast markings also aid people with vision impairments, but no MUTCD provisions for the use of high-contrast pavement markings has yet been developed.
- In highly urban areas (C-5 and C-6), at compact signalized intersections and at other locations with higher levels of pedestrian activity, pedestrian signals should automatically show the WALK sign without requiring activation.
- Although it is not a traffic control device, colored and textured crosswalk design treatments are sometimes used between transverse lines to further delineate the crosswalk, provide contrast for the visually impaired, provide tactile feedback to drivers and improve aesthetics (**Figure 10.15**).

Care should be taken to ensure that the material used in these crosswalks is smooth, nonslip and visible. Avoid using a paver system that may shift and/or settle or that induces a high degree of vibration in wheelchair wheels.

Recommended Practice

The following practice is recommended:

- Provide marked crosswalks at urban signalized intersections for all legs of the intersection; and
- Provide a marked crosswalk across an approach controlled by a STOP sign where engineering judgment determines there is significant pedestrian activity and pedestrian safety or the minimization of vehicle-pedestrian conflicts is especially important at that particular location (also see section titled Design Elements for Intersections in Walkable Areas in this chapter).

Justification

Marked crosswalks are one tool to get pedestrians safely across the street and they should be used in combination with other treatments (such as curb extensions, pedestrian refuge islands, proper light-

ing and so forth). In most cases, marked crosswalks alone (without other treatments) should not be installed within an uncontrolled environment when speeds are greater than 40 mph according to AASHTO's *Guide for the Planning, Design and Operation of Pedestrian Facilities* (2004b) and FHWA's *Safety Effects of Marked vs. Unmarked Crosswalks at Uncontrolled Locations* (2002).

Pedestrians can legally cross the street at any intersection, whether a marked crosswalk exists or not. To enhance awareness by motorists, install crosswalks on all approaches of signalized intersections. If special circumstances make it unsafe to do so, attempt to mitigate the circumstance.

Curb Extensions

Background and Purpose

Curb extensions (also called nubs, bulb-outs, knuckles, or neck-downs) extend the line of the curb into the traveled way, reducing the width of the street. Curb extensions typically occur at intersections but can be used at midblock locations to shadow the width of a parking lane, bus stop, or loading zone. Curb extensions can provide the following benefits:

- Reduce pedestrian crossing distance and exposure to traffic;
- Improve driver and pedestrian visibility at intersections;
- Separate parking maneuvers from vehicles turning at the intersections;
- Visually and physically narrow the traveled way, resulting in a calming effect;
- Encourage and facilitate pedestrian crossing at preferred locations;
- Keep vehicles from parking too close to intersections and blocking crosswalks;
- Provide wider waiting areas at crosswalks and intersection bus stops;
- Reduce the effective curb-return radius and slow turning traffic;
- Provide space for level landings and clear space required at pedestrian push buttons, as well as

double perpendicular curb ramps with detectable warnings; and

- Provide space for streetscape elements if extended beyond crosswalks.

Curb extensions serve to better define and delineate the traveled way as being separate from the parking lane and streetside. They are used only where there is on-street parking and the distance between curbs is greater than what is needed for the vehicular traveled way.

Related Thoroughfare Design Elements

- Curb-return radii
- Channelized right turns
- Lane width
- Crosswalks
- Midblock crossings
- Bus stops at intersections
- Bus stops in the traveled way

General Principles and Considerations

General principles and considerations regarding curb extensions include the following:

- Curb extensions may be used at intersections in any context zone but are emphasized in urban centers (C-5), urban cores (C-6) and other locations with high levels of pedestrian activity.
- Curb extensions help manage conflict between modes, particularly between vehicles and pedestrians. The curb extension is an effective measure to improve pedestrian safety and comfort and might contribute to slower vehicle speed.
- The design of the curb extension should create an additional pedestrian area in the driver's field of vision, thereby increasing the visibility of pedestrians as they wait to cross the street, as shown in **Figure 10.16**.

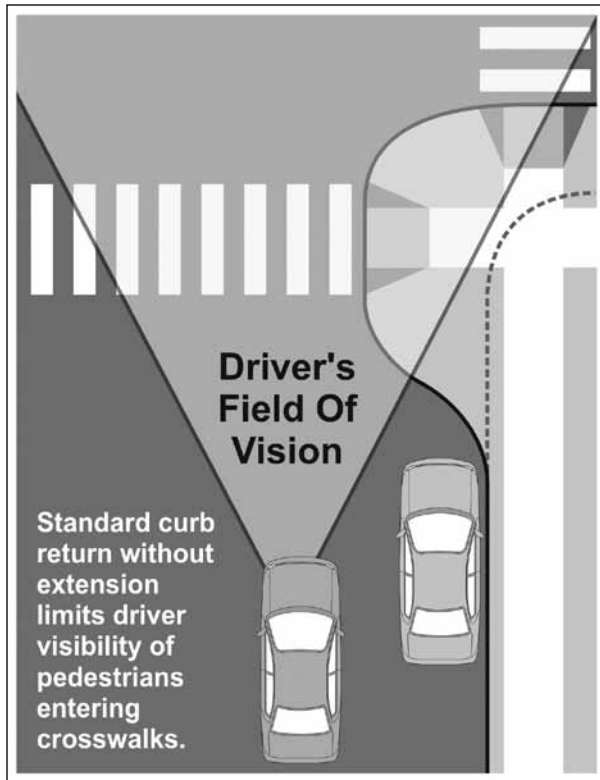

Figure 10.16 Curb extensions can improve pedestrian visibility and reduce crossing distance. Source: Digital Media Productions.

- Curb extensions are used only where there is on-street parking and where only a small percentage of turning vehicles are larger than the design vehicle.
- Curb extensions are not applicable to intersections with exclusive right-turn lanes adjacent to

the curb, or intersections with a high volume of right-turning trucks or buses turning into narrow cross streets.

- Carefully consider drainage in the design of curb extensions to avoid interrupting the flow of water along the curb, thus pooling water at the crosswalk.
- Curb extensions work especially well with diagonal parking, shadowing the larger profile of the row of parking and providing large areas in the pedestrian realm.
- Adjusting the curb-return radius can accommodate emergency vehicles and large design vehicles. An “effective” radius can accommodate the design vehicle through the use of a mountable (or flush with pavement) extension with bollards to delineate the pedestrian area as shown in **Figures 10.17** and **10.18**. Flush curb extensions are frequently combined with raised intersections. However, care should be taken to provide adequate vehicle turning paths outside the designated pedestrian waiting area.
- Where bicycle lanes exist, the curb extension must be outside the width of the bicycle lane.
- Design curb-extension radii to allow street cleaning vehicles to reach and turn all inside and outside corners. Normally this requires a radius of 15 feet. This will also help stormwater flow in the gutters around corners.
- Ensure good street lighting not only for pedestrians but so that the extension is visible to drivers at night and in adverse weather.



Figure 10.17 A mid block crossing with a flush curb in New Zealand. Pedestrians are separated from passing vehicles with bollards. Source: Community, Design + Architecture.



Figure 10.18 Use of contrasting material and bollards to delineate the pedestrian and vehicle areas. Source: Kimley-Horn and Associates, Inc.

Recommended Practice

The following practices are recommended when designing curb extensions on urban thoroughfares:

- Reduce crossing width at intersections by extending the curb line into the street by 6 feet for parallel parking and to within 1 foot of stall depth with angled parking. Ensure that the curb extension does not extend into travel or bicycle lanes.
- Apply the appropriate curb-return radius in the design of a curb extension. If necessary, use three-centered or asymmetric curb returns to accommodate design vehicles.
- Where buses stop in the travel lane, curb extensions can be used to define the location of the stop and create additional waiting areas and space for shelters, benches and other pedestrian facilities.
- When possible, allow water to drain away from the curb extension. In other cases a drainage inlet may need to be installed and connected to an existing underground storm-drain system.
- Curb extensions are usually constructed integral with the curb. In retrofit projects, curb extensions may be constructed away from the curb to allow drainage along the original flowline (**Figure 10.19**). Consider that this design might require additional maintenance to keep the flowline clear.
- When considering construction of curb extensions where an existing high road crown exists, reconstruction of the street might be necessary to avoid back draining the sidewalk toward abutting buildings. Slot drains along the sidewalk may provide an alternate solution.
- Sidewalks, ramps, curb extensions and crosswalks should all align with no unnecessary meandering.

Justification

Curb extensions in unused or underutilized street space can be used to shorten pedestrian crossing distance, increase pedestrian visibility and provide additional space for pedestrian queuing and support activity. Extensions can increase safety, efficiency and attractiveness.



Figure 10.19 Curb extensions may be used as landscaping or hardscape opportunities. This example shows a retrofit curb extension with drainage retained between the extension and the curb. Source: Community, Design + Architecture.

Bicycle Lane Treatment at Intersections

Background and Purpose

Selecting appropriate bicycle lane treatments at intersections requires providing uniformity in facility design, signs and pavement markings for bicyclists and motorist safety. The objective is to promote a clear

Related Thoroughfare Design Elements

- Bicycle lanes
- Curb extensions
- Right-turn channelization
- Lane width

understanding of safe paths through all intersection movements for bicyclists and motorists.

General Principles and Considerations

General principles and considerations regarding bicycle lane treatment at intersections include the following:

- Since bicyclists ride on the right-hand side of adjacent motor vehicle traffic, bicyclists desiring to travel straight through an intersection conflict with motor vehicles that are making a right turn at the intersection. On intersection approaches that have a shared through/right-turn lane, bicyclists not turning right need to position themselves in the center of the through/right lane to safely traverse the intersection and avoid conflicts with right-turning vehicles. For this reason, the bike lane, if used, should be dashed on the approach to the intersection stop bar to indicate that the motorist should share the space with the bicyclists.
- Similarly, bicycle lanes should be dashed in bus stops to encourage buses to pull all the way to the curb.
- On intersection approaches that have an exclusive right-turn lane, the bicycle lane should be positioned to the left of the right-turn lane. Drivers of right-turning motor vehicles moving into the turn lane have an obligation to yield to any present bicyclists. The higher-speed motor vehicle is usually approaching the beginning of the turn lane from behind the bicyclist and has a better view of the potential conflict.
- A more complex situation exists when an exclusive right-turn lane is created by dropping a through lane. The bike lane can typically transition from the right of the right-turn lane to the left of the right-turn lane with a shift in alignment.
- Where there are numerous left-turning bicyclists, a left-turn bicycle lane may be provided on an intersection approach. This lane is located between the vehicular left-turn lane and the adjacent through lane so that bicyclists can keep to the outside as they turn left.

- On approaches to roundabout intersections, the bicycle lane needs to be terminated 100 feet before the crosswalk, yield line or limit of circulatory roadway and should not be provided on the circulatory roadway of the roundabout intersection.

Recommended Practice

The recommended practice for bicycle lane treatment at intersections on urban thoroughfares is shown in **Table 10.3**.

Justification

At intersections, bicyclists proceeding straight through and motorists turning right must cross paths unless the cyclist moves to the center of the through-right travel lane. Therefore, striping bike lanes up to the stop bar conflicts with this movement. Striping and signing configurations that encourage crossings in advance of the intersection in a weaving fashion reduce conflicts at the intersection and improve bicycle and motor vehicle safety. Similarly, modifications such as special sight distance considerations, wider roadways to accommodate on-street lanes, special lane markings to channelize and separate bicycles from right-turning vehicles, provisions for left-turn bicycle movements and special traffic signal designs (such as conveniently located push buttons at actuated signals or even separate signal indications for bicyclists) also improve safety and operations and balance the needs of both transportation modes when on-street bicycle lanes or off-street bicycle paths enter an intersection.

Bus Stops at Intersections

Background and Purpose

Walkable thoroughfare design for bus stops at intersections emphasizes an improved environment for pedestrians and techniques for efficient transit operations. Design considerations for buses are addressed in detail in the section on midblock bus stops in Chapter 9.

Table 10.3 Recommended Practice for Bicycle Lane Treatment at Intersections on Walkable Urban Thoroughfares

Intersection Conditions and Related Recommendations	
With pedestrian crosswalks	
	<ul style="list-style-type: none"> • Bike lane striping should not be installed across any pedestrian crosswalks, and, in most cases, should not continue through any street intersections.
With no pedestrian crosswalks	
	<ul style="list-style-type: none"> • Bike lane striping should stop at the intersection stop line, or the near side cross street right-of-way line projection, and then resume at the far side right-of-way line projection. • Dash the bike lane prior to the stop line per MUTCD, to warn both motorists and cyclists of the need to prepare for right-turn movements at the intersection. • Bike lane striping may be extended through complex intersections with the use of dotted or skip lines.
Parking considerations	
	<ul style="list-style-type: none"> • The same bike lane striping criteria apply whether parking is permitted or prohibited in the vicinity of the intersection.
Bus stop on near side of intersection or high right-turn volume at unsignalized minor intersections with no stop controls	
	<ul style="list-style-type: none"> • A 6 to 8-inch solid line should be replaced with a dashed line with 2-foot dashes and 6-foot spaces for the length of the bus stop. Bike lane striping should resume at the outside line of the crosswalk on the far side of the intersection. • In the area of a shared through/right turn, the solid bike lane, if used, should be dashed to the stop bar to indicate that the right-turning motorist should share the space with bicyclists.
Bus stop located on far side of the intersection	
	<ul style="list-style-type: none"> • Solid white line should be replaced with a dashed line for a distance of at least 80 feet from the crosswalk on the far side of the intersection.
T-intersections with no painted crosswalks	
	<ul style="list-style-type: none"> • Bike lane striping on the far side across from the T-intersection should continue through the intersection area with no break. If there are painted crosswalks, bike lane striping on the side across from the T-intersection should be discontinued through the crosswalks.
Pavement markings	
	<ul style="list-style-type: none"> • Bike lane markings should be installed according to the provisions of Chapter 9C of the MUTCD. • The standard pavement symbols are one of two bicycle symbols (or the words "BIKE LANE") and an optional directional arrow as specified in the MUTCD. Symbols should be painted on the far side of each intersection. Pavement markings should be white and reflectorized.
Signs	
	<ul style="list-style-type: none"> • Bike lanes should be accompanied by appropriate signing at intersections to warn of conflicts (see Chapter 9B of the MUTCD).
Actuation at Traffic Signals	
	<ul style="list-style-type: none"> • If bike lane extends to the stop bar, provide a detector in the lane and appropriate pavement marking to indicate where the bicyclist should stop. • If the bicyclist shares a travel lane, provide a detector (and pavement marking) in the center of the lane. • If in-pavement or video detection is not possible, install a push-button on the curb accessible to the bicyclist.

Related Thoroughfare Design Elements

- Lane width.
- Curb extensions.
- Bus stops in the traveled way.
- Curb-return radius.
- Crosswalks.

Recommended Practice

Placement of Bus Stops at Intersections

The preferred location for bus stops is the near side or far side of an intersection. This location provides the best pedestrian accessibility from both sides of the street and connection to intersecting bus routes. While not preferred, bus stops on long blocks may be placed at a midblock location or to serve a major transit generator (See Chapter 9). Guidance and considerations related to bus stops at intersections include the following:

- Consider a near-side stop on two-lane thoroughfares where vehicles cannot pass a stopped bus.
- Consider a far-side stop on thoroughfares with multiple lanes where vehicular traffic may pass uncontrolled around the bus.
- On thoroughfares where vehicular traffic is controlled by a signal, the bus stop may be located either near side or far side, but far side is preferable.
- Where it is not desirable to stop the bus in a travel lane and a bus pullout is warranted, a far side or midblock stop is generally preferred. As with other elements of the roadway, consistency of stop placement lessens the potential for operator and passenger confusion.
- When locating a bus stop in the vicinity of a driveway, consider issues related to sight distance, blocking access to development and potential conflicts between automobiles and buses.
- The approach to a bus stop from the sidewalk to the bus must be fully accessible as defined by the U.S. Access Board. Bus stop access must in every case include a safe and accessible street crossing.

It must also contain a loading area of at least 5 feet by 8 feet for wheelchairs to board. (see Chapter 9)

The placement of bus stops at intersections varies from site to site. However, general considerations for the placement of bus stops at intersections include the following:

- When the route alignment requires a left turn, the preferred location for the bus stop is on the far side of the intersection after the left turn is completed.
- When the route alignment requires a left turn and it is infeasible or undesirable to locate a bus stop far side of the intersection after the left turn, a midblock location is preferred. A midblock bus stop should be located far enough upstream from the intersection so a bus can maneuver into the proper lane to turn left.
- If there is a high volume of right turns at an intersection or when the transit route turns right at an intersection, the preferred location for a stop is on the far side of the intersection.
- In circumstances where the accumulation of buses at a far-side stop would spill over into the intersection and additional length is not available, the stop should be placed on the near side of the intersection.
- At complex intersections with dual right- or left-turn lanes, far-side stops are preferred because they remove the buses from the area of complicated traffic movements.
- When there is substantial transfer activity between two bus routes on opposite sides of the street, placing one stop near side and one at the adjacent far-side location can minimize the number of crossings required to transfer between buses.

Table 10.4 summarizes the advantages and disadvantages of far-side and near-side bus stop placements.

Curb Extension Bus Stops (Bus Bulbs)

A curb extension may be constructed along streets with on-street parking. Curb extensions may be designed in conjunction with bus stops to facilitate bus operations and passenger access. The placement of a

Table 10.4 Advantages and Disadvantages of Far side and Near side Bus Stops

Far Side Bus Stops	
Advantages	Disadvantages
<ul style="list-style-type: none"> • Minimizes conflict between buses and right turning vehicles traveling in the same direction • Minimizes sight distance problems on approaches to the intersection • Encourages pedestrians to cross behind the bus • Minimizes area needed for curbside bus zone • If placed just beyond a signalized intersection in a bus turnout, buses may more easily re-enter the traffic stream • If a turnout is provided, vehicle capacity through intersection is unaffected • Can better take advantage of traffic signal priority for buses 	<ul style="list-style-type: none"> • If bus stops in travel lane, could result in traffic queued into intersection behind the bus (turnout will allow traffic to pass around the stopped bus) • If bus stops in travel lane, could result in rear-end accidents as motorists fail to anticipate stopped traffic • May cause passengers to access buses further from crosswalk • May interfere with right turn movement from cross street • May obscure sight distance for crossing vehicles • If signal priority not in use, bus may have to stop twice, once at signal and then at bus stop
Near Side Bus Stops	
Advantages	Disadvantages
<ul style="list-style-type: none"> • Minimizes interference when traffic is heavy on the far side of an intersection • Allows passengers to access buses close to crosswalk • Driver may use the width of the intersection to pull away from the curb • Allows passengers to board and alight when the bus is stopped for a red light • Provides the driver with the opportunity to look for oncoming traffic, including other buses with potential passengers 	<ul style="list-style-type: none"> • Stopped bus interferes with right turns • May cause sight distance problem for approaching traffic, cross-street traffic and pedestrians • If located in a pullout or shoulder or at a signalized intersection, a traffic queue may make it difficult for buses to re-enter the traffic stream • Prohibits through traffic movement with green light, similar to far side stop without a bus turnout • May cause pedestrians to cross in front of the bus at intersections • Limits use of traffic signal priorities

Source: *Bus Stop Safety and Design Guidelines Manual*, Orange County Transportation Authority and Kimley-Horn and Associates, Inc.

bus stop on a curb extension should follow the same guidelines as those previously stated (a near-side stop is preferred on two-lane streets where vehicles cannot pass a stopped bus; in the case of a street with multiple lanes where vehicular traffic may pass uncontrolled around the bus, a far-side stop is preferred for sight distance issues).

A bus stop on the near side of a single-lane approach of an uncontrolled intersection should completely obstruct the traffic behind it. Where it is not acceptable to have stopped buses obstruct a lane of traffic and a bus turnout is justified according to the criteria presented in Chapter 9 (section on midblock bus stops), a bus stop may be placed on the far side in the parking lane just beyond the curb extension. It might be appropriate to place a bus stop on a far-side curb extension at

an uncontrolled intersection if the warrants for a bus pullout are not met and its placement will not create a traffic hazard.

Near-side curb extensions are usually about 6 feet in width and of sufficient length to allow passengers to use the front and back doors of a bus. A near-side curb extension bus stop is shown in **Figure 10.20**.

Besides reducing the pedestrian crossing distances, curb extensions with near-side bus stops can reduce the impact to parking (compared to typical bus zones), mitigate traffic conflicts with autos for buses merging back into the traffic stream, make crossing pedestrians more visible to drivers and create additional space for passenger queuing and amenities, such as a shelter and/or a bench.



Figure 10.20 A near-side curb extension bus stop. Source: Kimley-Horn and Associates, Inc.

In areas where curb extensions are desired, but it is not acceptable to have the bus stop in the travel lane, a far-side pullout area can be created in the parking lane. This location and design eliminates the safety hazard of vehicles passing the bus prior to entering the intersection. However, bus stop length will likely be increased over the normal far-side length because of the need to add an approach taper to the stop downstream from the curb extension.

Queue Jumpers

Queue jumpers provide priority treatment for buses along arterial streets by allowing buses to bypass traffic queued at congested intersections. Queue jumpers evolved from the need to reduce bus delays at intersections or other congested locations. In the past, traffic engineers constructed bus turnouts to move buses out of the traffic stream while they are stopped for passengers. Bus turnouts introduce significant travel time penalties to bus patrons because buses are delayed while attempting to reenter the traffic stream. Queue jumpers provide the double benefit of removing stopped buses from the traffic stream to benefit the general traffic and getting buses through congested intersections so as to benefit bus operations.

Queue jumpers consist of a near-side right-turn lane (buses excepted) and a far-side bus stop and/or acceleration lane. Buses are allowed to use the right-turn lane to bypass traffic congestion and proceed through the intersection. Additional enhancements to queue jumpers could include an exclusive bus-only lane upstream from the traffic signal, extension of the right-turn lane to bypass traffic queued at the intersection, or advanced green indication allowing the bus to pass through the intersection before general traffic does.

Queue Jumper With an Acceleration Lane

This option includes a near-side right-turn lane (buses excepted), near-side bus stop and acceleration lane for buses with a taper back to the general purpose lanes on the far-side of the intersection.

Queue Jumper With a Far-Side Bus Stop

This option may be used when there is a heavy directional transfer to an intersecting transit route. Buses can bypass queues either using a right-turn lane (buses excepted) or an exclusive bus queue jump lane. Since the bus stop is located on the far side, a standard transition can be used for buses to reenter the traffic

stream. Queue jumpers at urban thoroughfare intersections should be considered when:

1. High-frequency bus routes have an average headway of 15 minutes or less;
2. Forecasted traffic volumes exceed 500 vehicles per hour in the curb lane during the peak hour and right-turn volumes exceed 250 vehicles per hour during the peak hour; and
3. Intersection operates at an unacceptable level of service (defined by the local jurisdiction).

Works Cited

American Association of State Highway and Transportation Officials. 2004a. *A Policy on Geometric Design of Highways and Streets*. Washington, DC: AASHTO.

American Association of State Highway and Transportation Officials. 2004b. *Guide for the Planning, Design and Operation of Pedestrian Facilities*. Washington, DC: AASHTO.

Federal Highway Administration. 2009. *Manual on Uniform Traffic Control Devices*. Washington, DC: FHWA.

Federal Highway Administration. 2000. *Roundabouts: An Informational Guide*. Washington, DC: FHWA.

Federal Highway Administration. 2002. *Safety Effects of Marked vs. Unmarked Crosswalks at Uncontrolled Locations*. Washington, DC: FHWA.

Oregon DOT. *Oregon Bicycle and Pedestrian Plan*.

Transportation Research Board. 2006. *Improving Pedestrian Safety at Unsignalized Crossings, NCHRP Report 562*. Washington, DC.

Federal Highway Administration. 2005. *Safety Effects of Marked Versus Unmarked Crosswalks at Uncontrolled Locations*. FHWA Publication #: HRT-04-100. Washington, DC: FHWA.

United States Access Board. *Accessible Public Rights-of-Way*. Accessible via www.access-board.gov/prowac/

Sources of Additional Information

American Association of State Highway and Transportation Officials. *A Guide to Achieving Flexibility in Highway Design*. Washington, DC: AASHTO, May 2004.

American Association of State Highway and Transportation Officials. *Guide for the Development of Bicycle Facilities*. Washington, DC: AASHTO, 1999.

American Planning Association. *Bicycle Facility Planning*. Chicago, IL: APA, 1995.

Congress for the New Urbanism. *Codifying New Urbanism*. Chicago, IL: American Planning Association, May 2004.

Federal Highway Administration. *Flexibility in Highway Design*. Washington, DC: FHWA, 1997.

Institute of Transportation Engineers. *Innovative Bicycle Treatments*. Washington, DC: ITE, 2002.

Insurance Institute for Highway Safety/Ryerson Polytechnic University. *Crash Reductions Following Installation of Roundabouts in the United States*. March 2000.

Jacobs, Allan. *Great Streets*. Cambridge, MA: MIT Press, 1995.

Leisch, Joel P. *Freeway and Interchange Geometric Design Handbook*. Washington, DC: ITE, 2005.

Oregon Department of Transportation. *Main Street—When a Highway Runs Through It, A Handbook for Oregon Communities*. Oregon Department of Transportation, November 1999.

Transportation Research Board. NCHRP Report 330: *Effective Utilization of Street Width on Urban Arterials*. Washington, DC: TRB, 1990.

Transportation Research Board. *NCHRP Report 500, Volume 3: A Guide for Addressing Collisions with Trees in Hazardous Locations*. Washington, DC: TRB, 2003.

Transportation Research Board. *NCHRP Report 524: Safety of U-Turns at Unsignalized Median Openings*. Washington, DC: TRB, 2004.

Public Rights-of-Way Access Advisory Committee (PROWAAC). *Special Report: Accessible Public Rights-of-Way: Planning and Designing for Alterations*. 2007.

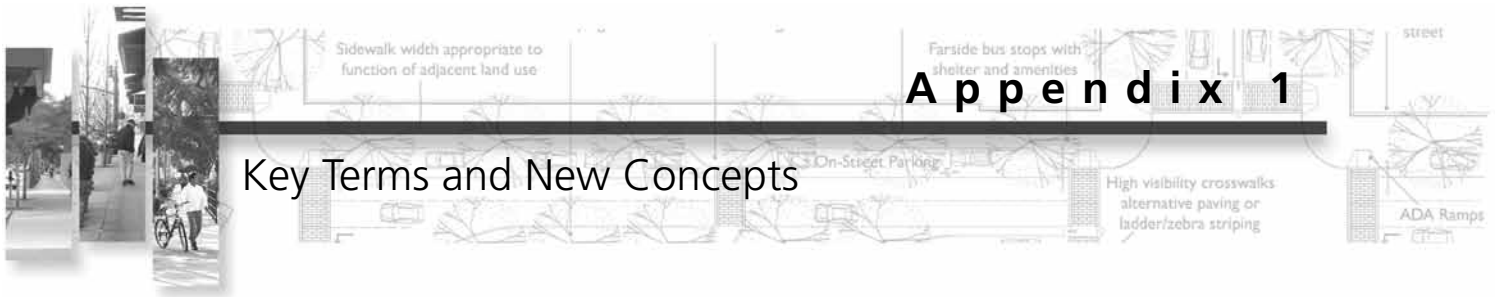

Key Terms and New Concepts

Accessibility—A term describing the degree to which something is accessible by as many people as possible. In transportation design, accessibility is often used to focus on people with disabilities and their right of access to thoroughfares, buildings and public transportation. Accessibility also refers to transportation facilities that comply with *Public Rights-of-Way Accessibility Guidelines* (PROWAG).

Access Management—Access management is defined as the management of the interference with through traffic caused by traffic entering, leaving and crossing thoroughfares. It is also the control and regulation of the spacing and design of driveways, medians, median openings, traffic signals and intersections on arterial streets to improve safe and efficient traffic flow on the road system.

Arterial—A street that typically emphasizes a high level of traffic mobility and a low level of property access. Arterials accommodate relatively high levels of traffic at higher speeds than other functional classes and serve longer distance trips. Arterial streets serve major centers of activity of a metropolitan area and carry a high proportion of the total urban area travel. Arterials also serve significant intra-area travel, such as between central business districts and outlying residential areas, between major inner city communities or major suburban centers. Arterial streets carry important intra-urban as well as intercity bus routes.

Articulation—An architectural term that refers to dividing building facades into distinct parts that reduce the appearance of the building's mass adjacent to the sidewalk, identify building entrances and minimize uninviting blank walls.

Bicycle Boulevard—A roadway that motorists may use that prioritizes bicycle traffic through the use of various treatments. Through motor vehicle traffic is discouraged by periodically diverting it off the street. Remaining traffic is slowed to approximately the same speed as bicyclists. STOP signs and signals on

the bicycle boulevard are limited to the greatest extent possible, except when aiding bicyclists in crossing busy streets.

Collector—A street that typically balances traffic mobility and property access. Collector streets provide land access and traffic circulation within residential neighborhoods, commercial and industrial areas. Collector streets pass through residential neighborhoods, distributing trips from the arterials through the area to the ultimate destination. Collector streets also collect traffic from local streets in residential neighborhoods and channel it into the arterial system. In the central business district, and in other areas of like development and traffic density, the collector system may include the street grid that forms a logical entry for traffic circulation.

Community—A group of people living within a defined geographic area or political boundary such as a neighborhood, district, town, city, or region. It is both a physical place of streets, buildings, schools and parks and a socioeconomic structure, often defined by qualities including social traits, values, beliefs, culture, history, government structure, issues of concern and type of leadership.

Community Livability—Refers to the environmental and social quality of an area as perceived by residents, employees, customers and visitors, including safety and health, local environmental conditions, quality of social interactions, opportunities for recreation and entertainment, aesthetics and existence of unique cultural and environmental resources.

Context—The nature of the natural or built environment created by the land, topography, natural features, buildings and associated features, land use types and activities on property adjacent to streets and on sidewalks and a broader area created by the surrounding neighborhood, district, or community. Context also refers to the diversity of users of the environment.

Context Sensitive Solutions (CSS)—Collaborative, interdisciplinary process that involves all stakeholders to design a transportation facility that fits its applicable setting and preserves scenic, aesthetic, historic and environmental resources while maintaining safety and mobility. CSS respects design objectives for safety, efficiency, capacity and maintenance while integrating community objectives and values relating to compatibility, livability, sense of place, urban design, cost and environmental impacts.

Context Zone—One of a set of categories used to describe the overall character of the built and natural environment, building from the concept of the “transect”—a geographical cross section through a sequence ranging from the natural to the highly urbanized built environment. There are six context zones plus special districts describing the range of environments including four urban context zones for the purpose of CSS—suburban, general urban, urban center and urban core.

Control Vehicle—A vehicle that infrequently uses a facility and must be accommodated, but encroachment into the opposing traffic lanes, multiple-point turns, or minor encroachment into the roadside is acceptable. A condition that uses the control vehicle concept arises where occasional large vehicles turn at an intersection with low opposing traffic volumes (e.g., a moving van in a residential neighborhood or once per week delivery at a business) or where large vehicles rarely turn at an intersection with moderate to high opposing traffic volumes (e.g., emergency vehicles).

Corridor—A transportation pathway that provides for the movement of people and goods between and within activity centers. A corridor encompasses single or multiple transportation routes or facilities (such as thoroughfares, public transit, railroads, highways, bikeways, etc.), the adjacent land uses and the connecting network of streets.

Corridor Plan—Document that defines a comprehensive package of recommendations for managing and improving the transportation system within and along a specific corridor, based upon a 20-year planning horizon. Recommendations may include any effective mix of strategies and improvements for many modes.

Corridor Planning—Process that is collaborative with local governments and includes extensive public participation opportunities. A corridor may be divided into logical, manageable smaller areas for the purpose of corridor planning.

Design Control—Factors, physical and operational characteristics, and properties that control or significantly influence the selection of certain geometric design criteria and dimensions. Design speed, traffic and pedestrian volumes, location and sight distance are examples of design controls.

Design Vehicle—Vehicle that must be regularly accommodated without encroachment into the opposing traffic lanes. A condition that uses the design vehicle arises where large vehicles regularly turn at an intersection with high volumes of opposing traffic (e.g., a bus route).

Edge Zone—The area between the face of curb and furnishing zone, an area of required clearance between parked vehicles or traveled way and appurtenances or landscaping.

Environment—The natural and built places within or surrounding a community. The natural environment includes the topography, natural landscape, flora and fauna, streams, lakes and watersheds, and other natural resources, while the human/built environment includes the physical infrastructure of the community, as well as its institutions, neighborhoods, districts, and historical and cultural resources.

Frontage Zone—The distance between the throughway and the building front or private property line that is used to buffer pedestrians from window shoppers, appurtenances and doorways. It contains private street furniture, private signage, merchandise displays, etc. The frontage zone can also be used for street cafes. This zone is sometimes referred to as the “shy” zone.

Functional Classification—A system in which streets and highways are grouped into classes according to the character of service they intended to provide.

Furnishings Zone—The area of the roadside that provides a buffer between pedestrians and vehicles. It

contains landscaping, public street furniture, transit stops, public signage, utilities, etc.

Human Scale—How humans perceive the size of their surroundings and their comfort with the elements of the natural and built environment relative to their own size. In urban areas, human scale represents features and characteristics of buildings that can be observed within a short distance and at the speed of a pedestrian, and sites and districts that are walkable. In contrast, auto scale represents a built environment where buildings, sites, signs, etc. are designed to be observed and reached at the speed of an automobile.

Intermodal—Refers to the connections between transportation modes.

Intersection—Where two or more public streets meet. They are characterized by a high level of activity and shared use, multi-modal conflicts, complex movements and special design treatments.

Local Street—Streets with a low level of traffic mobility and a high level of land access, serving residential, commercial and industrial areas. Local governments typically have jurisdiction for these streets.

Major Thoroughfare—As defined for this report, major streets (and rights-of-way, including improvements between the pavement edge and right-of-way line) in urban areas that fall under the conventional functional classes of arterials and collector streets. Thoroughfares are multimodal in nature and are designed to integrate with and serve the functions of the adjacent land uses.

Mixed-Use—The combining of, or zoning for, retail/commercial and/or service uses with residential or office use in the same building or on the same site either vertically (with different uses stacked upon each other in a building) or horizontally (with different uses adjacent to each other or within close proximity).

Mixed-use Area—Areas comprised of a mix of land uses, scales and densities that provide some level of internal pedestrian connectivity. The Urban Land Institute (ULI) defines mixed-use as “three or more significant revenue producing uses with significant functional and physical integration of the different uses that conform to a coherent plan.”

Mobility—The movement of people or goods within the transportation system.

Multimodal—Refers to the availability of transportation options within a system or corridor whether it be walking, bicycling, driving, or transit.

Multi-use Area—Areas containing two or more land uses that may or may not be complementary and interactive, but that have little or no internal connectivity by any travel mode, and have little or no shared access or shared parking. Nearly all interaction between buildings in this type of area is by motor vehicle travelling on public streets rather than within large parking areas.

New Urbanism—A multidisciplinary movement dedicated to the restoring of existing urban centers and towns within metropolitan regions, reconfiguring sprawling suburbs into real neighborhoods and diverse districts, conserving natural environments and preserving a community’s built legacy. The new urbanist vision is to transform sprawl and establish compact, walkable, sustainable neighborhoods, streets, and towns.

(Source: Charter of the New Urbanism and www.cnu.org)

Place/Placemaking—A holistic and community-based approach to the development and revitalization of cities and neighborhoods. Placemaking creates unique places with lasting value that are compact, mixed-use, and pedestrian and transit oriented, and that have a strong civic character.

(Source: www.placemakers.com and Chuck Bohl, “Placemaking”)

Public Participation—A collaborative process that encourages stakeholders to participate in the formation, evaluation and conclusion of a plan or transportation improvement project.

Right of way—The publicly owned land within which a thoroughfare can be constructed. Outside of the right-of-way the land is privately owned and cannot be assumed to be available for thoroughfare construction without acquiring the land through dedication or purchase.

Safety—A condition of being safe, free from danger, risk, or injury. In traffic engineering, safety involves reducing the occurrences of crashes, reducing the severity of crashes, improving crash survivability, developing programmatic safety programs and applying appropriate design elements in transportation improvement projects.

Sight Distance—Distance that a driver can see ahead in order to observe and successfully react to a hazard, obstruction, decision point, or maneuver.

Single-use Area—Single-use areas may be corridors or districts which are predominantly comprised of a single type of land use. Often the scale of single-use areas, their lack of a mix of uses and their associated roadway networks tend not to be conducive to walking. Transportation in single-use areas is primarily by motor vehicles, although transit and bicycling can be viable modes. Single-use areas might contain large tracts of housing such as subdivisions or commercial, or industrial uses that rely on freight movement and therefore need to accommodate significant numbers of large vehicles.

Smart Growth—Land use development practices that create more resource efficient and livable communities, with accessible land use patterns. It is an alternative to sprawl development patterns.

Stakeholders—Groups or individuals that have an interest (stake) in the outcome of the planning or project development process. Typical stakeholders include elected officials, appointed commissioners, metropolitan planning organizations, state and local departments of transportation, transit authorities, utility companies, business interests, neighborhood associations and the general public.

Streetside—The public right-of-way, which typically includes the planting area and sidewalk, from the back of the curb to the front property line of adjoining parcels. The roadside is further divided into a series of zones that emphasize different functions including the frontage, throughway, furnishings and edge zones. Transportation facilities, including bus shelters, waiting areas and bicycle parking, may be part of the roadside.

Thoroughfare—As defined for this report, major streets (and their rights-of-way, including improvements between pavement edge and right-of-way line) in urban areas that fall under the conventional functional classifications of arterials and collector streets excluding limited-access facilities. Thoroughfares are multi-modal in nature, and are designed to integrate with and serve the functions of the adjacent land uses.

Throughway Zone—The walking zone that must remain clear both horizontally and vertically for the movement of pedestrians.

Traditional Urban Environments—Places with development pattern, intensity and design characteristics that combine to make frequent walking and transit use attractive and efficient choices, as well as provide for automobiles and convenient and accessible parking. Traditional urban environments typically have mixed land uses in close proximity to one another, building entries that front directly on the street, building, landscape and thoroughfare design that is pedestrian-scale, relatively compact development, a highly-connected, multimodal circulation network, usually with a fine “grain” created by relatively small blocks, thoroughfares and other public spaces that contribute to “placemaking” (the creation of unique locations that are compact, mixed-use, and pedestrian and transit oriented, that have a strong civic character and with lasting economic value).

Transect—A continuum of contexts ranging from the natural and agricultural (parks, open space, farmland) to varying intensities of urbanism (from suburban to urban core). The transect is the basis for the four urban context zones used in this guidance.

Transitions—A change in thoroughfare type, context (e.g., rural to urban), right-of-way width, number of lanes, or neighborhood or district. Geometrically, transitions refer to the provision of a proper smooth taper where lanes or shoulders change width, lanes diverge or merge, or lanes have been added or dropped.

Traveled Way—The public right-of-way between curbs, including parking lanes, and the travel lanes for private vehicles, goods movement, transit vehicles and bicycles. Medians, turn lanes, transit stops and exclusive transit lanes, curb and gutter, and loading/unloading zones are included in the traveled way.

Traversable Community—Denotes the ability to travel within an area based on the area’s size, network connectivity, availability of multimodal facilities, and mix of uses that elicit the need to travel within the area. Large and predominantly single-use districts are most easily traversed by automobile; whereas compact mixed-use districts can be viably traversed by walking or bicycling.

Urban Area—As defined by federal-aid highway law (Section 101 of Title 23, U.S. Code) urban area means an urbanized area as an urban place as designated by the Bureau of the Census having a population of 5,000 or more.

Values—Attributes and characteristics regarded by a community as having ultimate importance, significance, or worth. Community values encompass the natural and built environment, its social structure, people and institutions. The term often refers to a set of principles, standards, or beliefs concerning the elements of the community that are of ultimate importance.

Vision—Part of the process of planning a community that involves residents looking into the future, thinking creatively and establishing what they want their community to be in a 20- or 50-year planning horizon. A vision describes an ideal picture and guides goal-setting, policies and actions by helping to understand community concerns, prioritize issues, determine necessary actions and identify indicators to measure progress. Successful visions include a future that:

- Balances economic, environmental and social needs from a long-term perspective in terms of decades or generations instead of years;
- Incorporates the views of a wide cross-section of the community; and
- Tracks its progress in reaching the future.

(Source: www.communitiescommittee.org)

Walkable—Streets and places designed or reconstructed to provide safe and comfortable facilities for pedestrians, and are safe and easy to cross for people of all ages and abilities. Walkable streets and places provide a comfortable, attractive and efficient environment for the pedestrian including an appropriate separation from passing traffic, adequate width of roadside

to accommodate necessary functions, pedestrian-scaled lighting, well-marked crossings, protection from the elements (e.g., street trees for shade, awnings, or arcades to block rain), direct connections to destinations in a relatively compact area, facilities such as benches, attractive places to gather or rest such as plazas and visually interesting elements (e.g., urban design, streetscapes, architecture of adjacent buildings).

Walkable Communities—Walkable communities possess these two attributes: first, by location, in a mixed-use area within an easy and safe walk of goods (such as housing, offices, and retail) and services (such as transportation, schools, libraries) that a community resident or employee needs on a regular basis. Second, by definition, walkable communities make pedestrian activity possible, thus expanding transportation options, and creating a streetscape that better serves a range of users—pedestrians, bicyclists, transit riders and automobiles. To foster walkability, communities must mix land uses and build compactly, and ensure safe and inviting pedestrian corridors.

(Source: www.smartgrowth.org)

Additional Sources of Definitions

Victoria Transport Policy Institute. TDM Encyclopedia Glossary. May 10, 2005. www.vtpi.org/tdm/tdm61.htm.

Federal Highway Administration. FHWA Functional Classification Guidelines, Section II. Concepts, Definitions, and System Characteristics. April 2000. www.fhwa.dot.gov/planning/fcsec2_1.htm.

Metropolitan Transportation Commission (San Francisco Bay Area). Arterial Operations Program Ped/Bike Safety Toolbox. April 2003. www.bayareatraffic-signals.org/toolbox/Tools/BikeBlvd.html



Appendix 2

Introduction to Context Sensitive Solutions (CSS)

What is CSS?

CSS is a different way to approach the planning and design of transportation projects. It is a process of balancing the competing needs of many stakeholders starting in the earliest stages of project development. It is also flexibility in the application of design controls, guidelines and standards to design a facility that works for all users regardless of the mode of travel they choose.

There are many definitions of CSS (see sidebar for example definitions from state DOTs) but they share a common set of tenets:¹

- “Balance safety, mobility, community and environmental goals in all projects;
- Involve the public and stakeholders early and continuously throughout the planning and project development process;
- Use a multidisciplinary team tailored to project needs;
- Address all modes of travel including pedestrians, transit/paratransit, bicycles, private motor vehicles and freight;
- Accommodate all types of travelers including young, old and disabled, as well as able bodied adults safely, conveniently and comfortably on all thoroughfares;
- Apply flexibility inherent in applying design guidelines and standards; and
- Incorporate aesthetics and accessibility as an integral part of good design.”

These tenets can be applied to the planning and design of any type of transportation project in any context, the result of which is aptly summarized in the

1. Expanded from a list of Principles from the Minnesota Department of Transportation as published on the University of Minnesota’s Center for Transportation Studies Web site www.cts.umn.edu/education/csd/index.html

CSS as Defined by State Departments of Transportation

“Context sensitive solutions use innovative and inclusive approaches that integrate and balance community, aesthetic, historic and environmental values with transportation safety, maintenance and performance goals. Context sensitive solutions are reached through a collaborative, interdisciplinary approach involving all stakeholders.”

California Department of Transportation

“Context Sensitive Solutions (CSS) is a philosophy wherein safe transportation solutions are designed in harmony with the community. CSS strives to balance environmental, scenic, aesthetic, cultural and natural resources, as well as community and transportation service needs. Context sensitive projects recognize community goals, and are designed, built and maintained to be sustainable while minimizing disruption to the community and environment.”

New York State Department of Transportation

“The essence of CSS is that a proposed transportation project must be planned not only for its physical aspects as a facility serving specific transportation objectives, but also for its effects on the aesthetic, social, economic and environmental values, needs, constraints and opportunities in a larger community setting. WSDOT endorses the CSS approach for all projects, large and small, from early planning through construction and eventual operation. CSS is a process that places a high value on seeking and, if possible, achieving consensus. WSDOT’s belief is that consensus is highly advantageous to all parties and may help avoid delay and other costly obstacles to project implementation.”

Washington State Department of Transportation

following quote from *A Guide to Achieving Flexibility in Highway Design* (AASHTO 2004):

“...a highway or transportation project that reflects a community consensus regarding purpose and need, with the features of the project developed to produce an overall solution that balances safety, mobility and preservation of scenic, aesthetic, historic and environmental resources.”

Why CSS is Important

CSS principles applied to the planning and design of a transportation project can make the difference between a successful project valued by the community or an embattled project taking years or even decades to complete, if ever. There are numerous examples of transportation projects that have ground to a halt or that have been held up in the courts long before final design is ever reached. Why? One common theme in these unsuccessful projects is not just contention over the project, but a lack of understanding of what the community values and a failure to address stakeholder issues and concerns. Some common issues that affect transportation projects include:

- Real or perceived incompatibility with surroundings;
- Community impacts;
- Emphasis on mobility without consideration of other community values;
- Disproportionate distribution of benefits or impacts (environmental justice); and
- Lack of stakeholder education and participation throughout the planning and design processes.

A CSS approach to the planning and design of a transportation project (otherwise referred to as a CSS process) cannot guarantee resolution of issues or even alleviate all contention. It can, however, minimize problems and delays by ensuring stakeholder involvement, identification of issues and community values and evaluation of alternative solutions that meet the needs and purpose of the project and address issues to the extent possible. A successful CSS process builds consensus on the best possible solution and promotes community ownership in the results.

Elements of Effective CSS

An effective CSS approach to transportation planning and project development can take many different forms, but should include the following key elements:

- A common understanding of the purpose and need of the transportation project;
- Stakeholder involvement at critical points in the project;

Benefits of CSS

“As an approach to transportation, CSS has spread rapidly since 1998. In large part this is because CSS practitioners and advocates understand and embrace its many important benefits:

- CSS solves the right problem by broadening the definition of “the problem” that a project should solve, and by reaching consensus with all stakeholders before the design process begins.
- CSS conserves environmental and community resources. CSS facilitates and streamlines the process of NEPA compliance.
- CSS saves time. It shortens the project development process by gaining consensus early, thereby minimizing litigation and redesign and expediting permit approvals.
- CSS saves money. Shortening the project development process and eliminating obstacles save money and time.
- CSS builds support from the public and the regulators. By partnering and planning a project with the transportation agency, these parties bring full cooperation, and often additional resources as well.
- CSS helps prioritize and allocate scarce transportation funds in a cost-effective way, at a time when needs far exceed resources.
- Group decisions are generally better than individual decisions. Research supports the conclusion that decisions are more accepted and mutually satisfactory when made by all who must live with them.
- CSS is the right thing to do. It serves the public interest, helps build communities and leaves a better place behind.”

Source: www.contextsensitivesolutions.org

- Multidisciplinary team approach to planning and design;
- Attention to community values and qualities including accessibility, environment, scenic, aesthetic, historic and natural resources, as well as safety and mobility; and

- Objective evaluation of a full range of alternatives.

Purpose and need: Understanding the purpose and need of the project includes developing an inclusive problem definition/statement that represents a common viewpoint of the problem among the stakeholders. According to the Federal Highway Administration (2005), “the purpose and need is the foundation of the decision-making process, influencing the rest of the project development process, including the range of alternatives studied and, ultimately, the selected alternative.” The generally accepted characteristics of an effective purpose and need statement include:

- The statement should be concise, easy-to-read and readily understandable.
- It should focus on essential needs, goals and policies for the project, which generally relate to transportation issues (such as mobility, safety, accessibility and reliability); it should be careful to delineate other desirable elements (environmental protection, scenic improvements) as separate from the purpose and need.
- It should be supported by data and policy that justify the need.
- It should focus on the problems that need to be addressed, and for which a proposed project is being considered, (for example, the purpose is to improve safety along a highway segment that has a high accident rate), and should not be written in a way that prematurely focuses on a specific solution or too narrowly constrains the range of alternatives (e.g., the purpose is to widen the highway).

Stakeholder involvement: Stakeholders are agencies, organizations, or individuals who have some level of authority over, an interest in, or may be potentially impacted by a transportation project. An effective CSS approach allows for meaningful stakeholder participation—meaning that stakeholders have an opportunity to participate in decisions or contribute in a way that can influence decisions. The CSS process can range from information dissemination, education and the provision of stakeholder input and comments to proactive hands-on involvement through town meetings, workshops, charrettes and advisory committees.

Multidisciplinary team approach: A multidisciplinary approach to planning and design incorporates the viewpoints of the various agencies, stakeholders and professionals who have roles or areas of concern in the transportation project. The different viewpoints allow coordination between different activities and resolution of competing interests. A multidisciplinary team approach can also result in a broader range of potential alternatives that meet multiple objectives. The makeup of planning and design teams can vary significantly depending on the nature of the project and can include anyone or any organization connected with the project, including, but not limited to, the following:

- Transportation planners;
- Highway/traffic and transit engineers;
- Environmental scientists;
- Resource agency representatives;
- Land use planners;
- Urban designers, architects;
- Landscape architects, urban foresters;
- Property owners;
- Users;
- Utility and transit owners/operators;
- Community and interest group leaders/representatives;
- Elected or appointed officials; and
- Fire, police, highway maintenance representatives.

Attention to community values and important qualities: Citizens value specific attributes of their community, whether it is the economic vitality of their downtown, their history, ease of mobility and safe streets, the quality of schools, natural resources, scenic qualities, or their system of parks. These important values can be overlooked in the evaluation process. The CSS approach works with stakeholders and the community to identify their values. It strives to integrate these values into evaluation criteria, and develop alternatives to preserve and enhance community attributes and address concerns.

Objective evaluation of a full range of alternatives: At a minimum, the development of alternatives must meet the purpose and need of the project. Ideally,

alternatives developed in a CSS approach meet the purpose and need, preserve and enhance community values and address stakeholder concerns. They also educate the design professional about factors that are important for project success and acceptance. Objectivity is important and all possibilities should be screened in a process that involves the stakeholders. The development, evaluation and screening of alternatives are opportunities to educate non-technical stakeholders.

For a more detailed discussion of the elements of an effective CSS process refer to *NCHRP Report 480: A Guide to Best Practices in Achieving Context Sensitive Solutions* (TRB 2002).

Conventional Process Versus CSS

There are fundamental differences in the approaches to design that can result in different outcomes. Conventional thoroughfare design is frequently driven by traffic demand and level of service objectives. The first two design elements of a thoroughfare are typically determined in the transportation planning process—functional classification and number of lanes. The outcome of this vehicle mobility-focused process influences the rest of the design process, from working with stakeholders to the final design. A pre-determined outcome can be a source of conflict with stakeholders that delays or even stops projects because the thoroughfare design may not be considered compatible with its surroundings or does not address the critical concerns of the community.

CSS-inspired thoroughfare design also begins the transportation planning process with an emphasis on identifying critical factors and issues before establishing design criteria. Certainly functional classification, travel forecasts and levels of service are factors to consider in CSS, and may be a high priority objective under many circumstances. Through a multidisciplinary approach, including a full range of stakeholders, the process seeks to identify the core issues/problems, develop a spectrum of alternatives and reach consensus on the best solution. The process may determine that level of service needs to be balanced along with environmental, historic preservation, or economic development objectives in the community. This process

results in a well thought out and rationalized design tradeoff—the fundamental basis of CSS.

An inclusive process is not a guarantee of success, but it often results in early acceptance and community ownership of transportation projects. The tenets of CSS in thoroughfare design are summarized in the principles described in the next section.

CSS Principles, Processes and Outcomes

The qualities and characteristics of a transportation project were originally developed at a conference in Maryland in 1998 entitled “Thinking Beyond the Pavement.” In 2007, at a meeting of the AASHTO Standing Committee on Highways, a group of FHWA, state department of transportation and institutional representatives refined the definition and principles of CSS resulting in a list of process characteristics and outcomes. These process characteristics and outcomes have become measures by which successful context sensitive solutions are judged.²

Based on the refined definition, context sensitive solutions is guided by a process which:

- Establishes an interdisciplinary team early, including a full range of stakeholders, with skills based on the needs of the transportation activity.
- Seeks to understand the landscape, the community, valued resources and the role of all appropriate modes of transportation in each unique context before developing engineering solutions.
- Communicates early and continuously with all stakeholders in an open, honest and respectful manner, and tailors public involvement to the context and phase.
- Utilizes a clearly defined decision-making process.

² Refer to “Results of Joint AASHTO/FHWA Context Sensitive Solutions Strategic Planning Process, Summary Report, March 2007”. Prepared by the Center for Transportation and the Environment at North Carolina State University. The document can be found at www.contextsensitivesolutions.org.

- Tracks and honors commitments through the life cycle of projects.
- Involves a full range of stakeholders (including transportation officials) in all phases of a transportation program.
- Clearly defines the purpose and seeks consensus on the shared stakeholder vision and scope of projects and activities, while incorporating transportation, community and environmental elements.
- Secures commitments to the process from local leaders.
- Tailors the transportation development process to the circumstances and uses a process that examines multiple alternatives, including all appropriate modes of transportation, and results in consensus.
- Encourages agency and stakeholder participants to jointly monitor how well the agreed-upon process is working, to improve it as needed, and when completed, to identify any lessons learned.
- Encourages mutually supportive and coordinated multimodal transportation and land-use decisions.
- Draws upon a full range of communication and visualization tools to better inform stakeholders, encourage dialogue and increase credibility of the process.

Context sensitive solutions lead to outcomes that:

- Are in harmony with the community and preserve the environmental, scenic, aesthetic, historic, and natural resource values of the area.
- Are safe for all users.
- Solve problems that are agreed upon by a full range of stakeholders.
- Meet or exceed the expectations of both designers and stakeholders, thereby adding lasting value to the community, the environment and the transportation system.
- Demonstrate effective and efficient use of resources (people, time and budget,) among all parties.



Institute of Transportation Engineers

1099 14th Street, NW
Suite 300 West
Washington, DC 20005-3438
USA

www.ite.org

CONGRESS
FOR THE
NEW
URBANISM

The Marquette Building
140 S. Dearborn Street, Suite 404
Chicago, IL 60603
USA

www.cnu.org